

This article will illustrate the application of Process Analytical Technology (PAT) as an important contributor to the “triple bottom line,” a measure of a company’s economic, environmental, and social performance, and the sustainability of the pharmaceutical industry.

## PAT and Green Chemistry: The Intersection of Benign by Design and Quality by Design

by Dr. Berkeley W. Cue, Dr. John Berridge, and Julie B. Manley

The pharmaceutical industry continues to face challenges such as rising healthcare costs, changing regulatory requirements, and developing the product pipeline. Mechanisms to increase efficiency through the introduction of new technology early in the development process are being demonstrated to improve manufacturing efficiency with an impact on the financial bottom line. More pharmaceutical companies are turning to green chemistry and its 12 principles for waste reduction as a new focus for cost containment. Process Analytical Technology (PAT) plays an important role in green chemistry, and as a result, it has a positive impact on the “triple bottom line” – a measure of a company’s economic, environmental, and social performance. Therefore, process understanding and the application of PAT early in process development are important to the sustainability of the pharmaceutical industry. PAT has heretofore been recognized for its value to product quality and efficient production. This discussion will illustrate the environmental and social benefits of PAT, demonstrating that the application of PAT is an important contributor to the “triple bottom line,” performance of a company, and the sustainability of the pharmaceutical industry.

### Introduction

Why should the pharmaceutical industry be interested in green chemistry? Simply stated, it is an important “how” in the how to become a sustainable company and a sustainable industry. The mission of the pharmaceutical industry, “pharmaceutical companies are devoted to discovering and developing new medicines that will enable patients to live longer, healthier, and more productive lives,”<sup>1</sup>

is among the noblest missions any industry can undertake. However, without a commitment to a healthy environment, this industry’s mission is incomplete. Like all industries that use chemistry to produce the products that are the life blood of its sustainability, the pharmaceutical industry produces waste as part of the manufacture of the medicines it sells. It has been reported<sup>2</sup> that on average, only one percent of the raw materials extracted from the earth to manufacture all finished product consumed on our planet end up in the final product; the remaining 99% becomes waste. This analysis is based on the current consumption, primarily in the western nations and Japan. As the economies of the third world, especially China and India, where 40% of our planet’s population resides, begin to acquire the goods and services typical of western middle class consumption, estimates suggest the resources of three to four planet Earths will be required to provide all the raw materials needed if utilization efficiencies do not improve.<sup>3</sup>

The pharmaceutical industry’s manufacturing waste metrics are worse than those reported above. A study published by Sheldon<sup>4</sup> in 1994 showed that among the major chemical industry sectors (oil refining, bulk chemicals, fine chemicals, and pharmaceuticals) pharmaceutical manufacturing generated the most waste per unit of product-between 25 kg (55 lb) and 100 kg (220 lb) or more of waste per kilogram (2.2 lb) of Active Pharmaceutical Ingredient (API) produced - *Table A*, and these numbers only reflect the use of advanced intermediates as starting points. This performance metric, called an E-Factor, has been rationalized at various times by the relative length of the syntheses, the complexity of the target molecules, the

*Continued on page 10.*

Reprinted from  
**PHARMACEUTICAL  
ENGINEERING®**  
The Official Magazine of ISPE

March/April 2009,  
Vol. 29 No. 2

©Copyright ISPE 2009  
www.ISPE.org

# DeltaV Batch.

## The perfect cup. Every time.



### Easy.

Emerson understands your need to quickly respond to varying customer requirements. That's why we designed DeltaV Batch to give you the robust, repeatable performance that lets you assure your customers of a perfect, on-spec batch. First time. Every time. Easy.

From seamless integration with your enterprise planning and manufacturing execution systems to modular, class-based configuration and integrated change management, DeltaV Batch simplifies your batch operations.

Enabling agile manufacturing has never been easier. So, grab yourself a fresh cup and visit: [EasyDeltaV.com/Batch](http://EasyDeltaV.com/Batch)



The Emerson logo is a trademark and a service mark of Emerson Electric Co. ©2008 Emerson Electric Company



**EMERSON. CONSIDER IT SOLVED.™**

Industry Sector	Product Tonnage	kg Byproducts/ kg of Product (E-factors)
Oil refining	106 – 108	ca 0.1
Bulk Chemicals	104 – 106	< 15
Fine Chemicals	102 – 104	5-50
Pharmaceuticals	101 – 103	25-100+

Table A. E-Factor for sectors of the chemical industry by quantity of byproduct per kg of product.

batch nature of pharmaceutical manufacture, and even by the low volumes of product compared to say, bulk chemicals. While there have been some notable successes in reducing E-Factors for selected drugs, based on the limited reports to date, not much progress has been made in lowering these waste metrics industry wide.

A benchmarking study made public in 2007 by the American Chemical Society (ACS) Green Chemistry Institute (GCI) Pharmaceutical Roundtable suggests that the E-Factor Sheldon identified for the pharmaceutical industry is fairly consistent with current industrial data. The Roundtable is a partnership between the ACS GCI® and member pharmaceutical companies dedicated to the integration of green chemistry and green engineering in the global pharmaceutical industry. The Roundtable decided to focus on Process Mass Intensity (PMI), somewhat different than the E-Factor in that it focuses on the amount of material used in a process rather than the waste generated. However, the median PMI for processes in this study representing seven major pharmaceutical companies was 120 kg (264 lb) material used/kg API.<sup>5</sup> The study also concluded that solvent was the major contributor to PMI. A recent publication analyzing API lifecycles by GSK scientists<sup>6</sup> indicates that most of the waste (approximately 80%) is solvent related with the remainder being solids. This finding suggests the biggest impact on waste volume reduction can be achieved by focusing on solvents and solvent utilization. Green chemistry is the tool that enables this.

## What is Green Chemistry?

Green chemistry has been defined by Anastas and Warner<sup>7</sup> as the utilization of a set of principles that reduces or eliminates the use or generation of hazardous substances in the design, manufacture, and application of chemical products. They described a set of 12 principles that were based on best practices for waste reduction and waste avoidance.

Green chemistry has become so powerful at redefining how molecules and the processes to make them can be designed to minimize hazardous waste that the US Environmental Protection Agency (EPA) has created the Presidential Green Chemistry Challenge<sup>8</sup> and awards best practices each year based on five focus areas. Through 2008, winners have achieved the following results annually: eliminated 193 million pounds (87,500 mt) of hazardous chemicals and solvents – enough to fill an 11-mile long train; saved 57 million pounds (26,000 mt) of carbon dioxide – equal to taking 6,000 automobiles off the road; eliminated 21 billion pounds (9.5M mt) of water – enough to meet the annual needs of 820,000 people, Winners

and nominees annually are saving one billion pounds (453,000 mt) of hazardous chemicals and solvents from the products and processes we use every day.<sup>9</sup>

## Why Should the Pharmaceutical Industry be Interested in Green Chemistry?

Among the pharmaceutical companies winning this EPA recognition are Boots Health Care in 1997 for the redesign of the ibuprofen process; Lilly in 1999 for improvements in the talampanol process; Roche Colorado Corporation for substantial improvements to its ganciclovir process; Pfizer in 2002 for the redesign of its process to make sertraline hydrochloride; BMS in 2004 for replacing a semi synthetic process to paclitaxel, the API in Taxol, with a process based on plant cell fermentation; and Merck in 2005 and 2006 for

<b>1. Prevention</b> It is better to prevent waste than to treat or clean up waste after it has been created.
<b>2. Atom Economy</b> Synthetic methods should be designed to maximize the incorporation of all materials used in the process into the final product.
<b>3. Less Hazardous Chemical Syntheses</b> Wherever practicable, synthetic methods should be designed to use and generate substances that possess little or no toxicity to human health and the environment.
<b>4. Designing Safer Chemicals</b> Chemical products should be designed to effect their desired function while minimizing their toxicity.
<b>5. Safer Solvents and Auxiliaries</b> The use of auxiliary substances (e.g., solvents, separation agents, etc.) should be made unnecessary wherever possible and innocuous when used.
<b>6. Design for Energy Efficiency</b> Energy requirements of chemical processes should be recognized for their environmental and economic impacts and should be minimized. If possible, synthetic methods should be conducted at ambient temperature and pressure.
<b>7. Use of Renewable Feedstocks</b> A raw material or feedstock should be renewable rather than depleting whenever technically and economically practicable.
<b>8. Reduce Derivatives</b> Unnecessary derivatization (use of blocking groups, protection/deprotection, temporary modification of physical/chemical processes) should be minimized or avoided if possible, because such steps require additional reagents and can generate waste.
<b>9. Catalysis</b> Catalytic reagents (as selective as possible) are superior to stoichiometric reagents.
<b>10. Design for Degradation</b> Chemical products should be designed so that at the end of their function they break down into innocuous degradation products and do not persist in the environment.
<b>11. Real-time Analysis for Pollution Prevention</b> Analytical methodologies need to be further developed to allow for real-time, in-process monitoring and control prior to the formation of hazardous substances.
<b>12. Inherently Safer Chemistry for Accident Prevention</b> Substances and the form of a substance used in a chemical process should be chosen to minimize the potential for chemical accidents, including releases, explosions, and fires.

Table B. The 12 Principles of Green Chemistry.

*Continued on page 12.*

# ARE YOU RELYING ON SAFETY PRODUCTS THAT **"SHOULD"** WORK?

**FIKE IS COMMITTED TO RELIABLE SAFETY SOLUTIONS THROUGH  
RESEARCH, NEW TECHNOLOGIES, AND EXTENSIVE TESTING.**

## EXPLOSION PROTECTION • PRESSURE RELIEF • TESTING SERVICES

- Comprehensive selection of ASME, CE and 3-A rupture/bursting discs
- High performance explosion vents, specifically designed for sanitary applications
- Complete line of products designed for CIP/SIP applications
- Dedicated Team of Combustion Engineers and Pressure Relief Experts

**DON'T LEAVE THE SAFETY OF YOUR BUSINESS TO ANYTHING LESS  
THAN THE MOST RELIABLE, PROVEN PRODUCTS.**



EXPLOSION  
VENTING



EXPLOSION  
SUPPRESSION



RUPTURE  
DISCS



FULL-SCALE  
TESTING

# Fike®

[WWW.FIKE.COM](http://WWW.FIKE.COM)

**PROVEN PERFORMANCE, QUALITY AND RELIABILITY FOR OVER 60 YEARS**

Visit us at Interphex NYC, Booth #1360

**1-866-758-6004**

reducing the environmental footprint of its aprepitant (for Emend) and sitagliptin (for Januvia) processes by almost ten-fold, respectively. Merck reported an estimated annual savings of \$14 million per year from the improved process for imipenem (Primaxin).<sup>10</sup> Roche Ireland, Ltd. won a Cleaner Technologies Award sponsored by the Irish Business and Employers Confederation for its process changes to mycophenolate mofetil (MMF), the active ingredient in the Cellcept immune-system suppressant given to transplant patients to prevent rejection of a new organ. Roche reported recouping its \$1 million investment in MMF in one year.<sup>11</sup> While this list is not a comprehensive summary, it is still impressive, yet it represents just a small fraction of the APIs that are manufactured every year to support a global drug industry generating more than \$700 billion in sales in 2007.<sup>12</sup>

How much waste is produced by the pharmaceutical industry? It is not possible to know the amount precisely, but an estimate can be made from the annual sales and some assumptions about average dose and daily selling price as well as using Sheldon's E-Factor ranges. Thus, calculations suggest that as much as three billion kilograms (6.6 billion lb) of waste could be co-produced in the manufacture of the API that is contained in the medicines sold. And, as the large patient populations in the third world start getting access to these medicines, the total waste footprint of this industry will increase dramatically, unless a significant improvement in the environmental profile of each process is achieved. Using E-Factors reported for the green chemistry award winning processes, the total waste profile could be reduced as much as 75% or more.<sup>13</sup> This waste represents a double economic penalty to the industry. Purchased chemicals that do not end up in the API represent lost opportunity costs as well as the regulatory costs associated with disposing of the waste byproducts and solvents. Given the pressure this industry is under to address and reduce its manufacturing costs makes green chemistry a business imperative going forward.

## How are Quality by Design (QbD) and Benign by Design (BbD) Related?

It has long been recognized that QbD offers significant advantages in the reduction of waste<sup>14</sup> and hence the creation of more benign processes. In advocating the implementation of QbD principles, the FDA cites waste reduction as one of the many industry benefits.<sup>15</sup> The tie in of PAT with green chemistry comes from principles six and 11: real-time analysis further developed to allow for real-time, in-process monitoring and control to maximize energy efficiency and to reduce the formation of hazardous substances. Process analytical technology represents an important tool in the pharmaceutical process developer's tool box, both for drug substance and drug product. The need to stock this tool box with greener technologies was highlighted as one of eight grand challenges for sustainability of the chemical and pharmaceutical industry for the 21<sup>st</sup> century.<sup>16</sup>

There have been significant developments over the past few years recognizing the importance of designing quality into pharmaceutical products. As part of the FDA's PAT initia-

tive,<sup>17</sup> FDA and pharmaceutical industry representatives have come together to define a framework for Quality by Design concepts. In this context, "the goal of PAT is to understand and control the manufacturing process, which is consistent with our current drug quality system: *quality cannot be tested into products; it should be built-in or should be by design.*" Similar wording is present in the ICH Guideline on Pharmaceutical Development (Q8) wherein it states, "It is important to recognize that quality cannot be tested into products, i.e., quality should be built in by design."<sup>18</sup> European regulators have an analogous initiative: "The PAT initiative focuses on building quality into the product and manufacturing processes, as well as continuous process improvement."<sup>19</sup>

For both industry and regulators, a desired goal of the PAT framework is to design and develop processes that can consistently ensure a predefined quality at the end of the manufacturing process. Such procedures would be consistent with the basic tenet of Quality by Design and could reduce both risks to quality and regulatory concerns while improving efficiency. Gains will vary depending on the product and are likely to come from:

- reducing production cycle times by using on-, in-, and/or at-line measurements and controls
- preventing re-processing, rejects and scrap
- considering the possibility of real time release
- increasing automation to improve operator safety and reduce human error
- facilitating continuous processing to improve efficiency and manage variability
- using small-scale equipment (to eliminate certain scale-up issues) and dedicated manufacturing facilities
- improving energy and material use and increasing capacity
- facilitating continual improvement, especially within the approved design space(s) to optimize process efficiency

Similarly, the goal of green chemistry's application of a PAT framework is that minimizing the environmental footprint of an API process must be an intentional act of design, "*Benign by Design*" or BbD. Quality by Design advocates seek reproducibly high quality processes and products with fewer process and product defects, leading to fewer rejects and reworks. Green chemistry advocates seek this outcome and a process or product that is much less intrusive to the environment. It is possible to have a synthetic process that is well designed, well understood, and well controlled, yet fails to meet any of the green chemistry metrics such as low E-Factors and higher atom economy.<sup>20</sup> Thus, the pharmaceutical processes that were recognized by the green chemistry challenge awards, while well controlled by cGMP standards, nevertheless could be improved in terms of robustness and reliability when examined by a green chemistry lens. In the future, instead of applying green chemistry principles to the redesign of API processes post regulatory approval, as has often been the case so far, a future state must be that green chemistry principles be incorporated into the design of the API manufacturing process

*Continued on page 14.*



# ELETTACQUA

*pure water technologies*

SINCE 1966

## PHARMACEUTICAL WATER SYSTEMS



DOUBLE PASS REVERSE OSMOSIS HIGH TEMPERATURE SANITIZATION

DESIGN AND CONSTRUCTION OF PURIFIED WATER PACKAGES ♦ DOUBLE PASS REVERSE OSMOSIS ♦ R.O. + ELECTRODEIONIZATION HOT WATER SANITIZABLE ♦ ULTRAFILTRATION ♦ MULTIPLE - EFFECT DISTILLATION UNITS ♦ PURE STEAM GENERATORS ♦ STORAGE AND DISTRIBUTION LOOP ♦ COMPLETE TURN KEY PROJECTS ♦ VALIDATIONS IQ, OQ

[www.elettracqua.com](http://www.elettracqua.com)

visit us at  
**ACHEMA 2009**  
Frankfurt am Main / Germany  
11. - 15. 5. 2009  
hall 4.1 - stand L20/L22



as early as possible in R&D.<sup>21, 22</sup> Lilly Research Laboratories developed a green synthesis for LY300164 with significant process, environmental, and safety improvements, yet the drug candidate never made it to market.<sup>9</sup> Quality by Design concepts, by themselves, may not be enough to drive substantial improvements in the environmental profile of API processes or lower their E-Factors. There are some impressive reports of using PAT tools to improve API manufacture, particularly in the areas of reaction completion and crystallization/particle size control<sup>23-28</sup> which can be translated or extended to yield environmental benefits.

The success of the pharmaceutical industry relies on its ability to be innovative. Reliance on conventional practices in quality or chemistry poses a threat to the viability of the industry and to public health for which the industry has dedicated its business. Both green chemistry and PAT are intended to support innovation. A mechanistic understanding of the process is the ultimate goal: a combination of conventional and green chemistry principles supported by PAT can yield this understanding more powerfully than conventional practices alone.

Process understanding would enable a chemist to develop a process that not only has quality, but sustainability designed in. While PAT is most clearly associated with the 11<sup>th</sup> principle of green chemistry: the incorporation of real time analysis for pollution prevention, the implementation of PAT affects many of the other principles as well. Using a generic example of online solvent monitoring during a drying operation, the sensors would indicate the optimal endpoint. If the dryer is stopped at the endpoint, the potential for generation of out-of-specification material is reduced (Green Chemistry Principle 1: Waste Prevention); dryer energy consumption is minimized (Green Chemistry Principle 6: Design for Energy Efficiency); and employee exposure to the API during routine sampling is reduced (Green Chemistry Principle 12: Inherently Safer Chemistry for Accident Prevention).

Pharmaceutical manufacturers recognize the green chemistry challenges presented by current methodologies for equipment cleaning.<sup>29</sup> An example by Johnson & Johnson was not selected for its use of solvents, but for its case study demonstrating the beneficial impact of UV spectroscopy during cleaning and cleaning validation. The study concluded the benefits of PAT to include improved quality by enabling detection of cross-contamination risks, improved cleaning process design based on improved process understanding of temperature, pressure, and hold time factors, more than 40% reduction in cycle time, and 40% cost reduction due to reduced solvent usage and waste reduction.<sup>30</sup>

## The Parallels of QbD and BbD

ICH has defined a **Critical Quality Attribute (CQA)** as, “A physical, chemical, biological, or microbiological property or characteristic that should be within an appropriate limit, range, or distribution to ensure the desired product quality.” The term **quality** was defined in ICH Q6A as, “The suitability of either a drug substance or drug product for its intended use. This term includes such attributes as the

identity, strength, and purity.” However, given the concerns that society has regarding environmental impact, is society prepared to pursue this definition of quality without regard to the environment?

Take, for example, the lengths the industry goes to in order to reduce the levels of impurities in APIs. While there is always a risk associated with the presence of impurities in APIs and drug products, an agreement was reached within ICH over the concept of a qualified level of an impurity. **Qualification** is the process of acquiring and evaluating data that establishes the biological safety of an individual impurity or a given impurity profile at the level(s) specified. Therefore, there is an agreement that once an impurity is below a particular level, it can be considered ‘safe.’ Despite this agreement, specification acceptance criteria for impurities are constantly under pressure during the regulatory review process to be reduced – sometimes to a concept of As Low As Reasonably Practical (ALARP). Such practicality rarely considers the environmental impact of the energy input and waste solvent disposal that may ensue as a consequence of demanding impurity levels be considerably lower than their qualified levels. In the 21<sup>st</sup> Century, it may be appropriate to consider whether quality should be redefined as, “The suitability of either a drug substance or drug product for its intended use. This term includes such attributes as the identity, strength, and purity, together with the environmental impact of its production.”

Maybe this seems a step too far? Then it may alternatively be helpful to extend the definition of a **Critical Process Parameter** as, “A process parameter whose variability has an impact on a critical quality attribute and therefore should be monitored or controlled to ensure the process produces the desired quality. Green chemistry could define a **Critical Environmental Parameter (CEP)**. A CEP could be defined as “a physical, chemical biological, or microbiological characteristic that should be within an appropriate limit, range, or distribution to ensure the desired environmental outcome” - *Figure 1*.

The parallels then with the ICH guideline become clear. For example, ICH Q8 states:

*“At a minimum, those aspects of drug substances, excipients, container closure systems, and manufacturing processes that are critical to product quality should be determined and control strategies justified. Critical formulation attributes and process parameters are generally identified through an assessment of the extent to which their variation can have impact on the quality of the drug product.”*

This could be re-presented as:

*“At a minimum, those aspects of drug substances, excipients, container closure systems, and manufacturing processes that are critical to the environment and to product quality should be determined and control strategies justified. Critical formulation attributes, process parameters, and environmental parameters are gener-*

ally identified through an assessment of the extent to which their variation can have impact on the quality of the drug product and the environmental impact of its production.”

However, the Annex to Q8 (Q8(R1) currently at Step 4) goes further to distinguish between the minimum expectations and QbD. “An enhanced, Quality by Design approach to product development would additionally include the following elements:

A systematic evaluation, understanding, and refining of the formulation and manufacturing process, including:

- identifying, through, e.g., prior knowledge, experimentation, and risk assessment, the material attributes and process parameters that can have an effect on product CQAs
- determining the functional relationships that link material attributes and process parameters to product CQAs

Using enhanced process understanding in combination with quality risk management to establish an appropriate control strategy can, for example, include a proposal for design space(s) and/or real-time release.

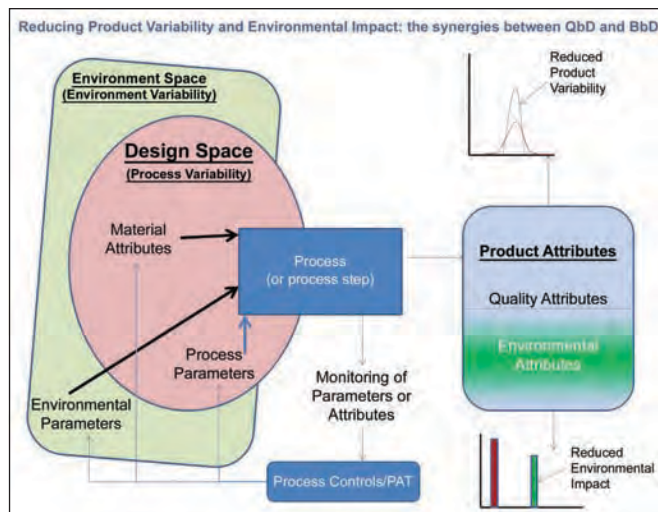

Figure 1. Benign by Design (BbD): A systematic approach to development that begins with predefined environmental objectives and emphasizes product and process understanding aimed at realizing environmentally benign manufacturing processes.

As a result, this more systematic approach could facilitate continual improvement and innovation throughout the product lifecycle (See ICH Q10 Pharmaceutical Quality System).

In BbD practice, the development scientist focusing on the enhanced approach would add to their target product profile,

*Continued on page 16.*

**Push a button and walk away**



**Automate your TOC analysis**



Be Right™

## Anatel PAT700: The first TOC analyzer for on-line release

- Simplify validation and reduce operator intervention with OASIS™ Onboard Automated Standards Introduction System
- Provide peace of mind, superior reliability and uptime with UV Detect™ and advanced diagnostics
- PAT design for compliance in the most demanding regulatory environments

**Call or email to schedule your demonstration:**

HACH COMPANY World Headquarters  
Toll Free: 800-866-7889  
Fax: 970-461-3914  
Email: [orders@hach.com](mailto:orders@hach.com)  
[www.hach.com](http://www.hach.com)



CQAs, and CPPs a series of environmental goals (CEPs) that would need to be met. Subsequent quality risk management processes would be used to identify those elements of the API or drug product manufacture that would put those goals at risk. Design of Experiments would then have a combination of both quality and environmental attributes that would need to be met and any design spaces that are created would consider both attributes. Referring back to the example of impurities, it becomes easy to see that there may well be an optimum region within a design space where impurity levels will be below their qualified levels **and** environmental impact can be minimized.

## Future Green Chemistry and Engineering Initiatives that Include PAT

It has been argued that the industry, or any industry for that matter, is reluctant to “green” a process in the absence of clear economic incentives.<sup>31</sup> The business case for PAT has been documented on several occasions,<sup>32,33</sup> but many fail to explicitly incorporate the environmental and safety benefits: cost avoidance from the avoidance of waste generation and disposal due to out-of-specification material, waste from reprocessing, energy and water consumption with reduced cycle times, etc. More recently, that situation is changing with recognition of the synergies between PAT, QbD, and a number of the principles of green chemistry.<sup>34</sup> The business case for PAT is only enhanced by the recognition of green chemistry principles.

In 2005, sales of generic drugs passed \$28 billion in the United States.<sup>35</sup> Over the next several years, as much as \$80 billion worth of prescription drugs goes off patent and the third world economies like India and China will begin to consume these drugs as well. As stated previously, the vast majority of APIs for products past patent expiry are manufactured using processes developed without the insight of green chemistry. Moreover, those processes for APIs nearing Loss of Exclusivity (LOE) which have been redesigned using green chemistry principles are protected by process patents which will be in force long after the composition of matter patents expire. Soon discerning analytical methods will be able to detect the unique impurity signature of each process variant almost at the molecular level. PAT is being used in the generic pharmaceutical industry.<sup>36</sup> Using generic versions of green branded drugs manufactured without an improvement in the environmental signature of API process that result from application of green chemistry principles can pose an additional environmental burden. Based on the E-Factor improvements achievable using green chemistry principles, this can be on the order of 10-fold or more. Developing green versions of processes for generic drugs represents a great opportunity for innovation.

Biopharmaceutical drugs such as vaccines, proteins, and monoclonal antibodies represent one of the fastest growing segments of the prescription drug industry with many companies in this sector seeing as much as 30% or more growth in sales in 2007 over 2004. The FDA's Webber<sup>37</sup> has analyzed these products in terms of the opportunities to use PAT tools to control the manufacturing processes for both API and dosage

form. Very little discussion into the green chemistry issues has appeared so far. Anecdotal comments such as “these products are green because they are made in water” oversimplify this issue.

Water shortage is becoming a critical issue, addressed at the 2008 World Economic Forum in a challenging discussion paper.<sup>38</sup> The discussion paper forecasts:

“Significant business disruptions due to water scarcity – across all sectors and geographies, and with all the associated technical, economic, political, environmental, and social implications – *are a reality today*, and are projected to *worsen in the future*, as a result of climate change and demographics. Governments play an important role in helping to mitigate and adapt to the challenge, but so does the private sector, through individual company actions and through innovative public-private and multi-stakeholder partnerships. CEOs are called to catalyse holistic water management actions up and down their respective supply chains and throughout the existing and new networks of which they are a part.

The focus of actions should include:

- water governance for transparent/fair allocation to users and sound incentives for efficient water use
- water for agricultural use (“more crop per drop;” 70% of water withdrawn worldwide)
- water for industry (water efficiency within operations)
- water for energy (the deepening link between water resources and climate change)
- water for human purposes (sustainable and affordable access to safe drinking water and sanitation)
- water for the environment (to ensure sustained eco-system security)

Therefore, it behooves the pharmaceutical industry to address its use of water in all its processes, both for API manufacture and in drug product manufacture. Genentech's 2005 environmental sustainability report<sup>39</sup> commits to water and energy usage reduction goals, water from a baseline of almost 900 kilograms per kilogram of marketed product. This number far exceeds water usage for the manufacture of a typical small molecule API and is more in line with what is reported for the manufacture of computer chips in the electronic materials.<sup>40</sup> Better process understanding for these molecules through application of PAT and application of green chemistry to process design should lead to a reduction in water and energy consumption with an overall improvement in their environmental footprint.

As pharmaceutical companies seek to streamline their API manufacturing processes, they are looking to technologies that have been common practice for other parts of the chemical enterprise. For example, separation technology such as Multi-column Chromatography (MCC) has been used to manufacture chiral versions of racemic drugs and starting materials such as escitalopram,<sup>41</sup> the chiral teralene for Pfizer's sertraline process<sup>42</sup> and tenofovir.<sup>43</sup> These preparative separation ap-

proaches which are tailor made for PAT, can reduce solvent utilization by as much as 10-fold over traditional preparative HPLC methods. Solvents that are recovered and reused can be purified using PAT methods to monitor quality, possibly improving recovery efficiency.

More recently, there has been a growing interest in Supercritical Fluid Chromatography (SFC).<sup>44</sup> This separation option will undoubtedly benefit from PAT enhancements as well. Perhaps the most revolutionary approach to API manufacture is continuous processing. Until now, APIs almost always have been manufactured in the batch mode. Conversely, basic chemicals and petroleum products are made in continuous flow reactors. Academic research groups are developing processes based on flow chemistry concepts.<sup>45,46</sup> Soon, if not already, these approaches will make their way into pharmaceutical industry R&D organizations, from the laboratory through pilot plant, and eventually into full scale production. The approach is being driven by considerations of speed to the market and the difficult R&D paradigm of solving scale issues, essentially reinventing the process several times moving from milligram to multi ton quantities. Unlike scaling up this new approach often called numbering up<sup>47</sup> or numbering out relies on defining critical process operating conditions at a fixed scale, then replicating that scale equipment as material demand increases. The benefits of integrating PAT into this new approach are obvious.

## Conclusion

Benign by Design (BbD) and Quality by Design (QbD) concepts are complimentary with both directed toward improving the understanding and the robustness of an API manufacturing process. In fact, as PAT practitioners in the pharmaceutical industry apply both BbD and QbD lenses, they may find a synergistic result (i.e., 1+1 = 3). Development scientists who fail to take advantage of the opportunity for PAT to improve the environmental profile may miss a significant economic benefit that comes from waste minimization or avoidance.

Finally, it appears most of the attention for QbD has been given to dosage form or drug product. On the other hand, formulations and packaging have received little attention from green scientists so far. Moreover, some of the emerging innovative drug delivery platforms that can increase oral bioavailability and/or target drug delivery to the desired physiological site offer great promise for reducing the environmental footprint of pharmaceutical manufacturing in their own right. A more efficient and effective formulation could achieve the same efficacy with less drug, reducing the need for API synthesis and lessening the burden of drug excreted into the environment. Once these new platforms are in hand, a detailed lifecycle analysis will be required to confirm or refute this prediction.

## References

1. [www.pharma.org](http://www.pharma.org).
2. Young, J. and Sachs, A., The Next Efficiency Revolution: Creating a Sustainable Materials Economy, Worldwatch Institute (Washington, DC), 1994, p. 13. [www.grrn.org](http://www.grrn.org).

*Continued on page 18.*

**BUDZAR**  
INDUSTRIES, INC.

Your Single Source Solution Provider

## Reactor Temperature Control Module

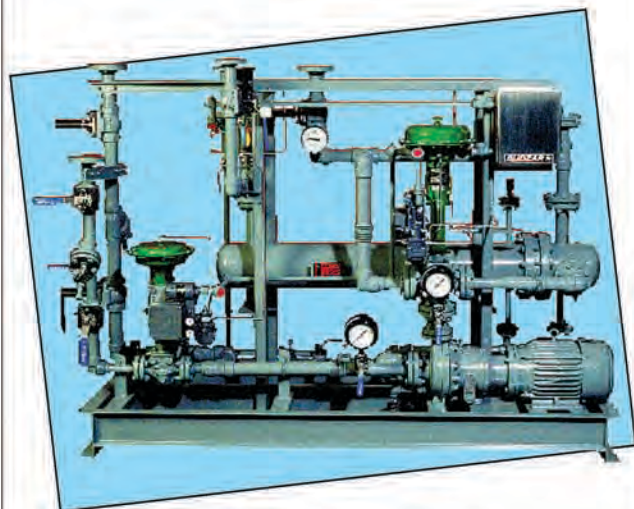

### Features Include:

- ◆ Temperatures from -100° - 700° F
- ◆ Water, glycol or heat transfer fluids
- ◆ Indoor, Outdoor and Explosion Proof
- ◆ Interface with all types of Plant Utilities
- ◆ Local, PLC or DCS Control Systems
- ◆ Batch size capacity to 10,000 gallon vessels
- ◆ Single Zone or Multi-Zone Designs
- ◆ NEMA 12, 4 or 7 electrical components & enclosure
- ◆ Direct Injection or Closed Loop Cooling
- ◆ Steam or electrical heater size of 4.5kW to 300 kW

Budzar Industries has specialized in process fluid heat transfer systems since 1975 and has earned a global reputation for quality and ingenuity in the design, engineering, and manufacturing of temperature control systems. Budzar Industries systems are found throughout the world, delivering accurate temperature measurement and control to the production of pharmaceuticals, chemicals, petroleum, rubber, power, steel, food, and plastics.

**Budzar Industries**  
38241 Willoughby Parkway  
Willoughby, Ohio 44094  
440-918-0505 • [www.Budzar.com](http://www.Budzar.com)

3. Wackernagel, M. and Rees, W., **Our Ecological Footprint: Reducing Human Impact on the Earth**, Philadelphia, Pennsylvania: New Society Publishers, 1996 and Hawkin, P., Lovins, A.B., and Lovins, L.H., **Natural Capitalism: Creating the Next Industrial Revolution**, Little, Brown & Company, 1999.
4. Sheldon, R.A., "Green Chemistry Performance Metrics: E-Factor," *Chem Tech*, Vol. 24, pp. 38-47.
5. Henderson, R.K., Kindervater, J., and Manley, J.B., "Lessons Learned Through Measuring Green Chemistry Performance – The Pharmaceutical Experience," presented at the 11<sup>th</sup> Annual Green Chemistry and Engineering Conference, Washington, DC, June 2007. [http://portal.acs.org/portal/fileFetch/C/CTP\\_005585/pdf/CTP\\_005585.pdf](http://portal.acs.org/portal/fileFetch/C/CTP_005585/pdf/CTP_005585.pdf)
6. Jimenez-Gonzalez, C, Curzons, A.D., Constable, D.J.C., and Cunningham V.L., "Cradle-to-Gate Life Cycle Inventory and Assessment of Pharmaceutical Compound," *International Journal of Life Cycle Assessment*, Vol. 9, No. 2, pp. 114-121.
7. Anastas, P.T. and Warner, J.C., **Green Chemistry: Theory and Practice**, New York, New York: Oxford University Press Inc., 1998.
8. [www.epa.gov/greenchemistry](http://www.epa.gov/greenchemistry).
9. EPA bulletin 744F08002, June 2008, [www.epa.gov/greenchemistry](http://www.epa.gov/greenchemistry).
10. Process Change in the Pharmaceutical Industry, Merck & Co., Inc. – Cherokee Plant, Source Reduction Success Story #4, Pennsylvania Source Reduction Program, April 1994.
11. Thomas, P., "The Greening of a Roche API Process: Pollution Prevention Pays," PharmaManufacturing.com, <http://www.pharmamanufacturing.com/articles/2006/175.html?page=print>.
12. [http://www.imshealth.com/ims/portal/front/indexC/0,2773,6599\\_83743725\\_0,00.html](http://www.imshealth.com/ims/portal/front/indexC/0,2773,6599_83743725_0,00.html)
13. Manley J.B., Anastas, P.T., and Cue, B.W., Jr., "Frontiers in Green Chemistry: Meeting the Grand Challenges for Sustainability in R&D and Manufacturing," *J. Cleaner Production*, 16 (2008), pp. 743-750.
14. Juran, J.M., "Juran on Quality by Design: The New Steps for Planning Quality into Goods and Services," *The Free Press*, 1992, ISBN 0-02-916683-7.
15. Winkle, H., Implementing Quality by Design, PDA/FDA joint Regulatory Conference, September 2007, <http://www.fda.gov/Cder/OPS/ImplementingQualitybyDesign.pdf>.
16. Sustainability in the Chemical Industry. Grand Challenges and Research Needs: A Workshop Report, Committee on Grand Challenges for Sustainability in the Chemical Industry, Board on Chemical Sciences and Technology, National Research Council, National Academies Press, 500 Fifth St., N.W., Washington, DC 20001, 2005. ([http://books.nap.edu/catalog.php?record\\_id=11437#toc](http://books.nap.edu/catalog.php?record_id=11437#toc)).
17. <http://www.fda.gov/cder/OPS/PAT.htm#Introduction>.
18. [www.ich.org](http://www.ich.org).
19. <http://www.emea.europa.eu/Inspections/PAThome.html>.
20. Trost, B.M., "The Atom Economy – A Search for Synthetic Efficiency," *Science*, Vol. 254, No. 5037, pp. 1471-1677.
21. Masanori, N., "Green Chemistry in Process Research and Development in Pharmaceutical Industry," *Journal of Synthetic Organic Chemistry*, Japan, Vol. 61, No. 5, pp. 464-471.
22. Erdhart, P.W., "Medicinal Chemistry in the New Millennium, a Glance into the Future," **Drug Discovery and Development**, Vol. 1; Chorghade, M.S., (Editor). Wiley-Interscience, ISBN: 9780471398486 (2006)
23. Thayer, A., "Know Thy Process," *Chemical and Engineering News*, Vol. 83, No. 22, pp 63-67.
24. Hammond, S., *The Journal of Process Analytical Technology*, Vol. 2, No. 4, pp. 15-7.
25. Rodrigues, L.O., Marques, J.L., Cardoso, J.P., Menezes, J.C., *The Journal of Process Analytical Technology*, Vol. 2, No. 3, p.12.
26. Higgins, J., Green, R., Pizley, N., Kleissas, K., Saikia, S., Chow, J., Zimmerman, J., Colvin, P., Plank, R., Hunke, B., Zega, J., Witulski, F., John, C., Smith, E., Bowen, B., Mateos, A., Reynolds, S., and Reed, R., *The Journal of Process Analytical Technology*, Vol. 2, No. 5, p. 23.
27. Szechinski, W., "PAT Application in Active Pharmaceutical Ingredient (API) Manufacturing and the Advancement to Real-Time Release," *The Journal of Process Analytical Technology*, Vol. 9, No. 6, pp. 20-22.
28. Hinz, D.C., *The Journal of Process Analytical Technology*, Vol. 1, No.2, pp.16-18.
29. Constable, D.J.C., Dunn, P.J., Hayler, J.D., Humphrey, G.R., Leazer, J.L., Jr., Linderman, R. J., Lorenz, K., Manley, J., Pearlman, B.A., Wells, A., Zaks, A., and Zhang, T.Y., "Key Green Chemistry Research Areas – A Perspective from Pharmaceutical Manufacturers," *Green Chemistry*, Vol. 9, No. 5, pp. 411-420.
30. Helings, M. and Vanbaelen, H., "The Application of PAT for Cleaning and Cleaning Validation," *American Pharmaceutical Review*, Issue 4, 2008, <http://www.american-pharmaceuticalreview.com/ViewArticle.aspx?SID=d5myce55zcrnzo232vkkxxia&ContentID=3587>.
31. DePalma, A., "Green Processing," *Pharmaceutical Manufacturing*, Vol. 5, No. 4, pp. 34-35.
32. Henningsson, U., *The Journal of Process Analytical Technology*, Vol. 2, No. 4, pp. 8-11.
33. Hormaza, M., "Overcome PAT's Barriers and Find its True Business Value," *Pharmaceutical Manufacturing*, <http://www.pharmamanufacturing.com/articles/2006/014.html>.
34. Woelbeling, C., Creating Quality by Design/Process Analytical Technology (QbD/PAT) Management Awareness, *Pharmaceutical Engineering*, Vol. 28, No.4.
35. <http://www.medicalnewstoday.com/medicalnews.php?newsid=30938>.
36. Lo, S.C., Venkatesh, K., and Foster Roberts, G., *The Journal of Process Analytical Technology*, Vol. 3, No. 1, p. 13.
37. Webber, K., "FDA Update: Process Analytical Technology for Biotechnology Products," *The Journal of Process Analytical Technology*, Vol. 9, No. 4, pp. 12-14.
38. <http://www.weforum.org/pdf/water/managing.pdf>.
39. <http://www.gene.com/gene/about/environmental/commitment/water.jsp>.

# Solutions for your successful Life Science Environments



Success in the life science industry is based on excellent environmental conditions. Let Siemens be your reliable partner providing safe, secure and compliant environments along each step of your value chain. Your investment is protected because we focus on the entire life cycle of your installation. Your environments are compliant because our solutions are based on all-inclusive systems and services developed specifically for the life science industry, and we can offer you decades of knowledge and experience in this industry – worldwide.

[www.siemens.com/buildingtechnologies-pharma](http://www.siemens.com/buildingtechnologies-pharma)

**SIEMENS**

40. Williams, E.D., Ayres, R.U., and Heller, M., "The 1.7 Kilogram Microchip: Energy and Material Use in the Production of Semiconductor Devices," *Environmental Science and Technology*, Vol., 36, No. 24, pp. 5504-5510.
41. Containing Resolution: The Novasep Newsletter, November 2001, www.novasep.com.
42. Hawkins, J.M. and Watson, T.J.N., "Asymmetric Catalysis in the Pharmaceutical Industry," *Angewandte Chemie International Edition*, Vol 43, No. 25, pp.3224- 3228.
43. Chemical Week Associates, CPhI Review, December 10, 2003.
44. Thayer, A., "Trial Separations," *Chemical and Engineering News*, Vol. 83, No. 36, pp. 49-53.
45. Baxendale, I.R., Deeley, J., Griffiths-Jones, C.M., Ley, S.V., Saaby, S., and Tranmer, G.K., "A Flow Process for the Multi-Step Synthesis of the Alkaloid Natural Product Oxomaritidine: A New Paradigm for Molecular Assembly," *J. Chem. Soc., Chem. Commun.*, pp. 2566-2568.
46. Broadwater, S.J., Roth, S.L., Price, K.E., Kobaslija, M., and McQuade, D.T., "One-Pot Multi-Step Synthesis: A Challenge Spawning Innovation," *Org. Biomol. Chem.*, Vol. 3, 2899-2906. Also, Choi, C.Q., "Nano World: Edible Nanotech on the Horizon," 11 February 2005.
47. For a discussion of numbering up and flow reactor concepts see M. Freemantle, *ACHEMA 2003 Report* contained in *Chemical and Engineering News*, Vol. 81, No. 24, pp 36-37.

## About the Authors



**Dr. Berkeley (Buzz) W. Cue**, consults with several technology companies who serve the pharmaceutical industry to create innovative solutions for pharmaceutical science and manufacturing challenges through BWC Pharm Consulting, LLC. Most recently, at Pfizer, he was responsible for the departments: Analytical R&D, Bio Process R&D, Chemical

R&D, Pharmaceutical R&D, Regulatory CMC, and Quality Assurance, and Pharmaceutical Sciences Business Operations that comprise Pharmaceutical Sciences at their Groton R&D site. He was a member of the Worldwide Pharmaceutical Sciences Executive Team, sponsored the global Chemical R&D line council, and was a member of the Groton Laboratories site Leadership Team. He created and led Pfizer's Green Chemistry initiative and has spoken extensively on this topic since 2000. Cue retired from Pfizer in April 2004 after almost 29 years, but he continues his mission of advancing green chemistry in the pharmaceutical industry. Since his retirement in 2004, he has given more than 80 presentations on green chemistry in the pharmaceutical industry. His professional society memberships include the American Chemical Society (ACS), ISPE, the American Institute of Chemical Engineers (AIChE), the American Association of Pharmaceutical Scientists (AAPS), and the New England Association of Chemistry Teachers (NEACT). He can be contacted by email: [b.cue@comcast.net](mailto:b.cue@comcast.net).

BWC Pharma Consulting, LLC., 12 Eska Dr., Ledyard, Connecticut 06339, USA.



**Dr. John Berridge** retired from Pfizer Global Research and Development at Sandwich in January 2006 as Vice President of Pharmaceutical Sciences. He spent more than 31 years at Pfizer, starting as an Analytical Chemist, and more recently responsible for all aspects of chemistry, pharmacy, analytical, and regulatory CMC in Europe. His research

interests have been directed toward high performance liquid chromatography with special emphasis on the use of chemometrics. This research was recognized by the award of the Chromatographic Society's Jubilee medal in 1989. Berridge was involved in the ICH processes from their inception until November 2007, representing EFPIA in the Quality topics discussions. He has contributed to guidelines on impurities in drug substances and their dosage forms, specifications, and the Common Technical Document (Quality); he was the Industry rapporteur for the pharmaceutical development guideline (Q8). In 1995, he was presented with an FIP IPS award for his outstanding contribution to industrial pharmacy and in 1997, he was awarded the Royal Pharmaceutical Society Chiroscience award for his services to the pharmaceutical industry. Berridge now acts as an independent consultant and as European Regulatory Affairs Advisor to ISPE. He can be contacted email: [john.berridge@orange.net](mailto:john.berridge@orange.net).



**Julie B. Manley** is President and Owner of Guiding Green, LLC, a sustainability consulting firm near Chicago, Illinois. Following approximately 10 years at Abbott Laboratories in manufacturing and environmental health and safety functions, Manley founded Guiding Green, LLC to have a broader impact on sustainability in the global pharmaceutical

industry. While Guiding Green, LLC initially focused on green pharmaceutical science and it will always remain a high priority, the organization has expanded the scope of work to help integrate sustainable practices in the broader industrial enterprise. Since 2005 she also has acted as the Senior Industrial Coordinator for the American Chemical Society Green Chemistry Institute® (ACS GCI) where she manages the ACS GCI Pharmaceutical Roundtable. Manley earned a BA from Northwestern University, Evanston, Illinois and a Master of Public Health from the University of Michigan, Ann Arbor, Michigan. She also is a Certified Hazardous Materials Manager (CHMM) by the Institute of Hazardous Materials Management. Manley has authored several papers on the subject of sustainability and green chemistry in peer reviewed and trade journals and presented on related subjects. She can be contacted by telephone: +1-815-325-4974 or by email: [julie.manley@GuidingGreen.com](mailto:julie.manley@GuidingGreen.com).

Guiding Green, LLC., 26508 W Melissa Dr., Channahon, Illinois 60410, USA. 

This article discusses the critical requirements for a Process Analytical Technology (PAT) data management solution and how these requirements contribute to the successful operation of the PAT solution.

## Introduction to PAT Data Management Solutions

by Mark N. Reed

### Introduction

This article will discuss the critical requirements for a PAT<sup>1</sup> data management solution and how these requirements contribute to the successful operation of the PAT solution with the end goal of real time product release. PAT Data Management is used in multiple phases of the PAT implementation model. The three phases of all PAT projects are learn, predict, and control. The learning phase comes from the data that is collected, as you “learn” more about your process. The data is then used to build models to “predict” what the process will do when a variation occurs. The model outputs are used to feedback control adjustments to the process control system in the control phase of the project.

First, in the learning phase, there are the process inputs that are collected from the process control system, laboratory analyzers, and the on-line analyzers. When using analyzers, there are software tools in the PAT data management system that allow the user to calibrate the analyzers to accurately detect the substance they are measuring to ensure the quality of the collected data. This calibration of an analyzer to a particular substance is called a method.<sup>2</sup>

Second, there is the storage of this data that allows understanding and predicting of the process. This data storage is performed by an industry standard database (historian) that accepts various input types and formats. It allows the user to pinpoint a specific event or to analyze the data to optimize the process. Chemometricians use univariate or (more typically) multivariate data analysis tools to analyze the data they obtain from the historian. A model that describes how the process is running can be developed using tools that provide outputs to the process control system that then send outputs to final control elements such as control valves and other types of actuators.

In the third phase, the process control system adjusts the Critical Process Parameters (CPPs) to adjust the process to obtain the desired Critical Quality Attribute (CQA) values. These CQAs are monitored and reported to the PAT system in real-time by the on-line instruments and analyzers. Business related attributes also need to be identified and considered as part of the overall PAT process. Visualization is another data analysis tool that allows the operator to inspect a graphic display to find where the process is operating within or outside of the

Figure 1. Examples of scalar data (left) and spectral data (right).

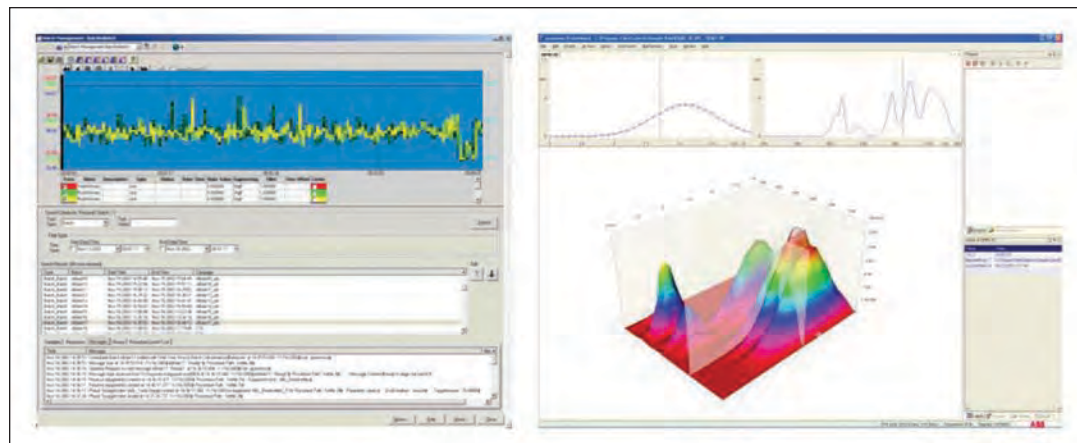

Reprinted from  
**PHARMACEUTICAL  
ENGINEERING**  
The Official Magazine of ISPE

March/April 2009,  
Vol. 29 No. 2

©Copyright ISPE 2009  
www.ISPE.org

Continued on page 24.

**In commissioning, validation and compliance, teamwork and timing are everything.**



COMMISSIONING AGENTS. We're in position, skillfully negotiating every turn to help you get to your project's finish line faster and more efficiently. Our teams undergo a rigorous program of structured training, qualification, and continuous professional development. You'll find we aren't selling individual resumes, we're selling a high performance team.

**For every project, teamwork and timing are everything.**



Commissioning Agents, Inc.

[WWW.COMMISSIONINGAGENTS.COM](http://WWW.COMMISSIONINGAGENTS.COM)

- ▶ **Commissioning planning and field execution**
- ▶ **Validation planning, protocol development and execution**
- ▶ **Process validation, cleaning, sterilization and computer validation**
- ▶ **Process improvement services: Process Analytical Technology (PAT), technology transfer and process studies**
- ▶ **Technical services including design reviews, SOP development, maintenance programs and training**
- ▶ **cGMP compliance audits and regulatory reviews, compliance improvement projects, comparability protocols and other submission assistance**

**Achieve world class manufacturing.**

**Call Robert E. Chew, P.E., Vice President**  
**[Robert.Chew@CAgents.com](mailto:Robert.Chew@CAgents.com)**  
**+1.317.710.1530**

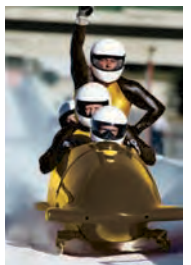

desired state defined by the process design space.

The overall technical requirements to consider in a PAT data management solution that will be discussed are the different types of data that needs to be stored, how the data will be stored, how the integration to the batch management system is done, and what FDA regulations need to be considered.

## Analyzer Data for Understanding the Process

There are many options on the market today to measure CQAs in real-time. Facilities may have multiple analyzers from multiple vendors throughout a site. How are these managed? How is data collected? How are the methods managed? Instrumentation and analyzers can be laboratory or process units that have outputs of either scalar (univariate) or spectral (multivariate) data which are available from various manufacturers. There are two categories of outputs that an analyzer presents to the user for measuring the attributes of the process - *Table A, Figure 1*.

Many or all of these are used by life science companies to measure CQAs. FT-NIR is, by far, the most widely used and proven analytical technology for PAT applications.<sup>3</sup> FT-NIR is the most popular due to its noninvasive nature with no sample preparation needed. It uses fiber optically coupled

Scalar Data	Spectral Data
Pressure	Fourier Transform Infrared (FT-IR),
Level	Fourier Transform Near-Infrared (FT-NIR)
Flow	Ultraviolet-Visible spectroscopy (UV-VIS)
Temperature	Raman
Conductivity	Focused Beam Reflectance Measurement (FBRM)
pH	Continuous Gas Analyzers (CGA)
Particle Size	Gas Chromatography (GC)
TOC	Mass Spectroscopy (MS)
	High Performance Liquid Chromatography (HPLC)

Table A. Examples of typical devices used in process measurements.

probes; these probes can be remote from the analyzers with several probes multiplexed into a single NIR unit.

Turnkey solutions that utilize these analytical methods on a unit-by-unit basis have been available for years. Unit solutions include reactors, dryers, solvent recovery, crystallization, raw material identification, blending, spray coating, solid dose uniformity, lyophilizations, and many others. However, these analyzers typically do not share a common data format or operator interface and do not easily exchange this

## Data Storage

To complete the first step of the “learn, predict, and control” process, data from the process must be collected and stored. There are two basic types of process and laboratory data measurements - scalar and spectra. Scalar measurements are typical process values, i.e., temperature, pressure, flow, pH, conductivity, TOC, particle size, level, etc. that are collected from process measurements and some types of analyzers. Spectral data (spectroscopic raw data) is generated by laboratory and process analyzers, is in the form of multiple arrays of data with timestamps, and is much larger and more complex than a typical scalar signal. Because of its three dimensions, it also is called vector data. Spectral data is collected and used everyday in laboratories and production areas, but is typically set up as standalone equipment with an individual workstation and analyzer or they are connected to a common network of identical analyzers. Rarely is the spectral data combined with data from other types of analyzers or from a process control system in a single database that allows an analysis from multiple data streams or allows ease of data retrieval.

A data manager to collect and store information for discrete, continuous, and batch processes should be structured according to the procedure and associated with the lot (batch or work order) ID. Lot information should include all spectral and scalar data and the meta-data with which it is associated. This includes data from control recipe execution, operator actions and comments, process alarms/events from equipment acquired by batch, runtime changes, the methods that the analyzers used

during their analysis, version control of the methods, the spectral data from laboratory and process analyzers, and the scalar data from the process. By storing the data in a format that associates it with the lot, it is easy to display and/or report any information from a specific lot or from an entire campaign. This retrieval would take advantage of today’s batch engines that use an ISA-88 model that defines a data structure for recipes, equipment, schedules, and history, along with integration to enterprise applications. This allows complete ease of recalling and using the data, as it is the same format as the process recipes and analyzer PAT methods.

To complete the second step of the “learn, predict, and control” process, the information learned during the first step must be organized and modeled to form a set of predictions for various process changes. After collecting the CQAs, tools are used to model the multivariate data to create predictions that characterize the batch - *Figure 2*. The output from this modeling identifies the status of the batch during each process step and predicts its output to the next process step and to the last process step that delivers the final product. Comparing predicted values from the current batch to a set of values recorded from acceptable batches provides a tool for assuring the quality level of in-process batches. This can be called operating to a golden batch, within the control space, or can be classified as Advanced Process Control (APC), but the result is the same; a way to predict the outcome of a batch based on the real time process measurements.

*Continued on page 26.*



# A Single Resource...



for TOTAL Cleanroom Confidence.

**Planning & executing the right cleanroom solution for your critical process.**

AES is your single resource to deliver fast track solutions for Pharma & BIO applications, such as:

- API Clean Containment
- Low cost ISO 8/CNC Macro Environments
- Fill/Finish Processes
- Cell Manufacturing Facilities
- Blow/Fill/Seal Facilities
- EU/Grade A Laminar Flow Upgrades

With the AES Pharma Wall System, combined with our expert knowledge of HVAC and process integration, let us show you how the AES "single resource" team can deliver maximum value to your cleanroom investment.

Call Grant Merrill at 888-237-2532 (ext. 139) to arrange your free consultation today.

**VISIT AES AT**  
**BIO Atlanta, GA**  
Booth 1433  
May 19, 20, & 21, 2009



**aes**

Clean Technology, Inc.

**1-888-AES-CLEAN ext. 139**  
237-2532

[aesclean.com](http://aesclean.com)

data with the plant's process control system and historical systems. In addition, the analyzers sample the process and produce results on different time frequencies determined by the amount of time the sampling takes and the sampling needs of the process. In a typical facility using these unit PAT operations, using multiple analyzers lead to large amounts of manual collection and correlation of the data from the facility's "islands of information." Having a system to provide a common user interface and common method development tool for different types of analyzers would enhance usability while reducing the system's training and long-term support costs.

On the topic of data, the FDA states:

*"Process analyzers typically generate large volumes of data. Certain data are likely to be relevant for routine quality assurance and regulatory decisions. In a PAT environment, batch records should include scientific and procedural information indicative of high process quality and product conformance. For example, batch records could include a series of charts depicting ac-*

*ceptance ranges, confidence intervals, and distribution plots (inter- and intrabatch) showing measurement results. Ease of secure access to these data is important for real time manufacturing control and quality assurance. Installed information technology systems should accommodate such functions."<sup>4</sup>*

An analyzer has a calibration associated with it that is comprised of a collection of spectral data and a customizable set of parameters describing a particular analysis procedure. These calibrations are used in quantitative and qualitative analysis either to find out an amount of a particular substance contained in a sample or to prove the identity of a substance or compound. Based on these pre-calculated results, reliable predictions for the identity of or an amount of a substance in an unknown sample can be made.<sup>5</sup> Calibration methods are used to control a set of calibration models that have had corresponding discrimination criteria introduced to them to avoid model selection problems and misleading result interpretation. Prior to a particular lot being started, these methods must be downloaded to the analyzer and confirmed by the

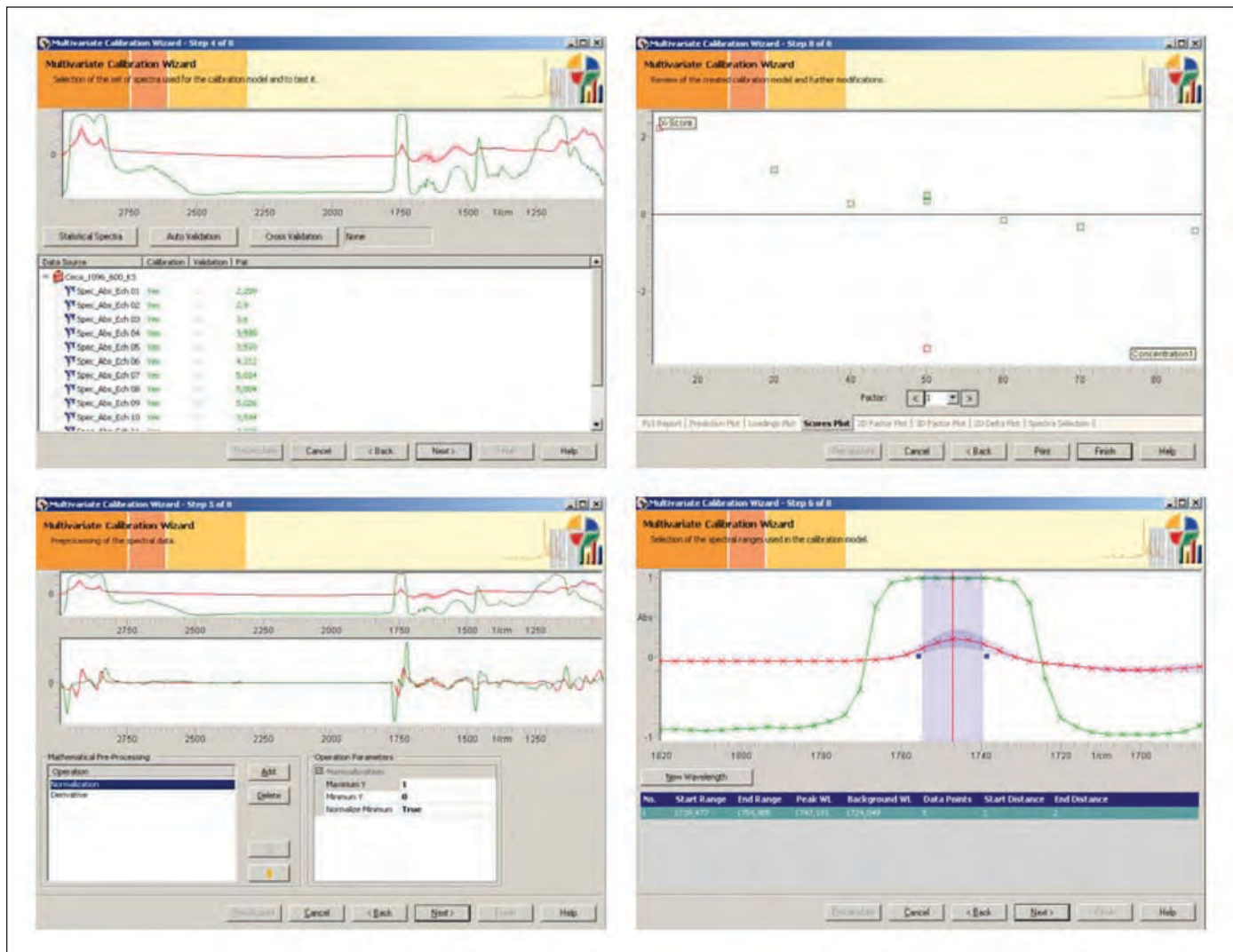
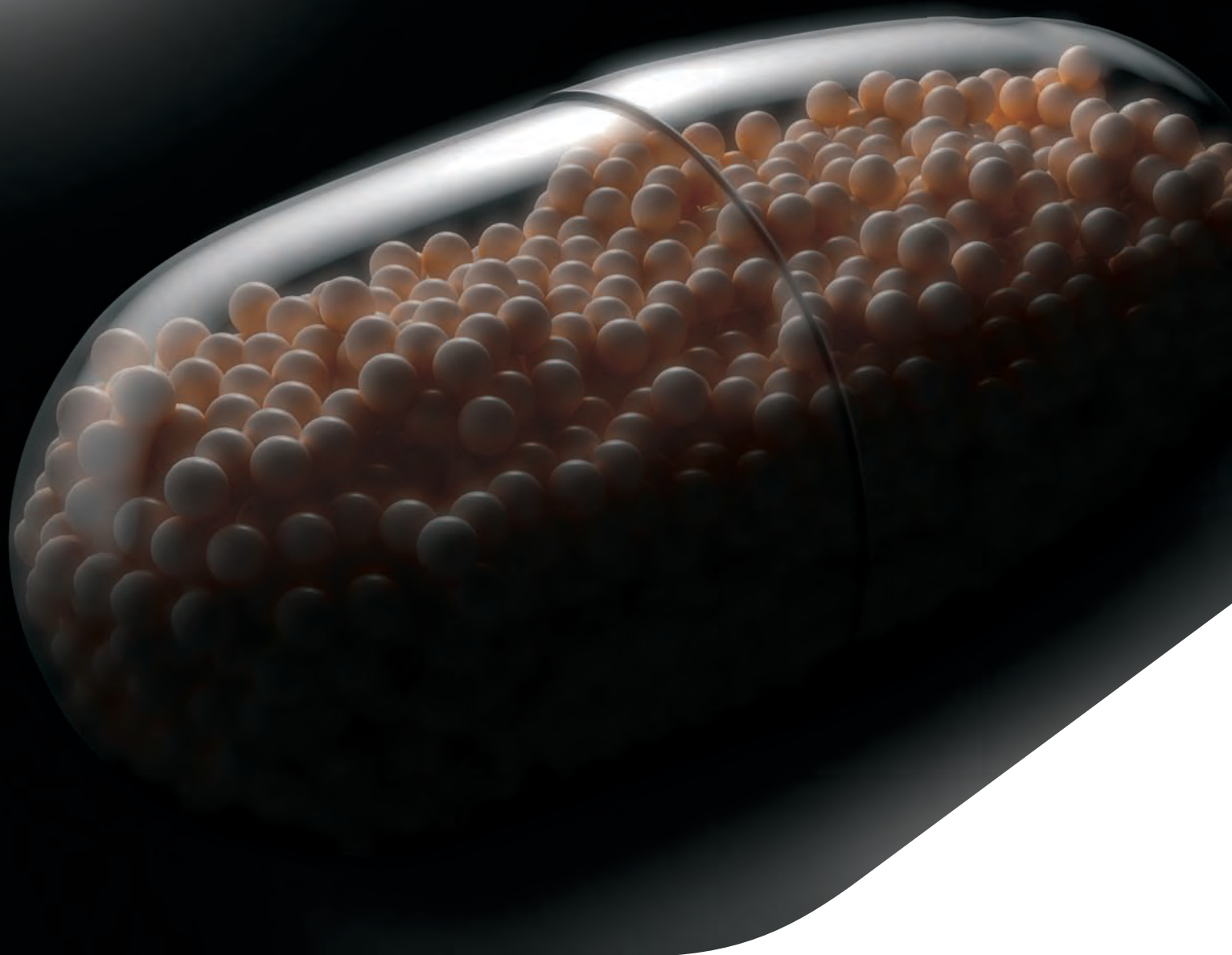

Figure 2. Example of multivariate model builder tool for data analysis.

Continued on page 28.

# The birth of a new species



Don't miss the event at **Achema 2009**

[www.ima.it/adapta](http://www.ima.it/adapta)

ACHEMA 2009

Frankfurt - May 11-15, 2009 / Halle 3.0 - Stand M2-P21

**IMA**  **ACTIVE**  
Solid Dose Solutions *division*

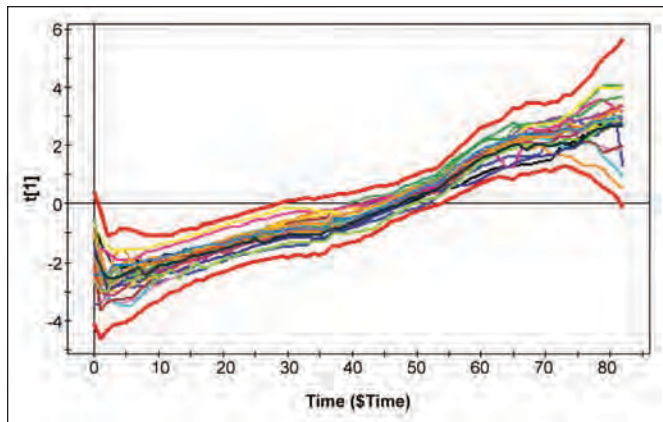

Figure 3. Example of batches that have run within their control space. (Control space graphic courtesy of Umetrics Inc.)

analyzer controller before analyzing samples. One function of the PAT data management system is to store these methods along with the audit trail confirming that this action has taken place for the lot that is preparing to run. The known method is necessary to validate the data collected from the analyzer during the lot.

When using multiple analyzers from various vendors, the complexity of managing the methods and correlating the data can grow rapidly, soon reaching a point at which it can be questioned if the results from the activity are worth the effort. Viewing the data also can be challenging when using

the different tools and formats that are delivered with the various vendor's analyzers. A PAT data management system that delivers a common format and approach for viewing the data from the various analyzers with a single tool saves time, money, and reduces mistakes. Another potential problem with combining data from multiple instruments is that the data from different types of analyzers will typically be produced over various durations and on different schedules. One analyzer may be producing results every 10 seconds, another analyzer may be producing results every 60 seconds, and the associated process control system instrumentation may be providing sample data at intervals of less than five seconds. All of this data is time stamped, but aligning all this data for use in analysis and feedback control is a critical requirement for accurate data analysis and modeling. If this time alignment of data is done manually using the time stamps, it can be very time consuming and prone to errors. Storing the data in a data management system that automatically aligns the data by time and by lot, reduces the errors from manual transcription and improves the process for using the data for real-time feedback control by ensuring that the process is being controlled using the correct data and proper calculations.

## Control System Integration for Controlling the Process

Once the scalar and spectral data is stored and time aligned

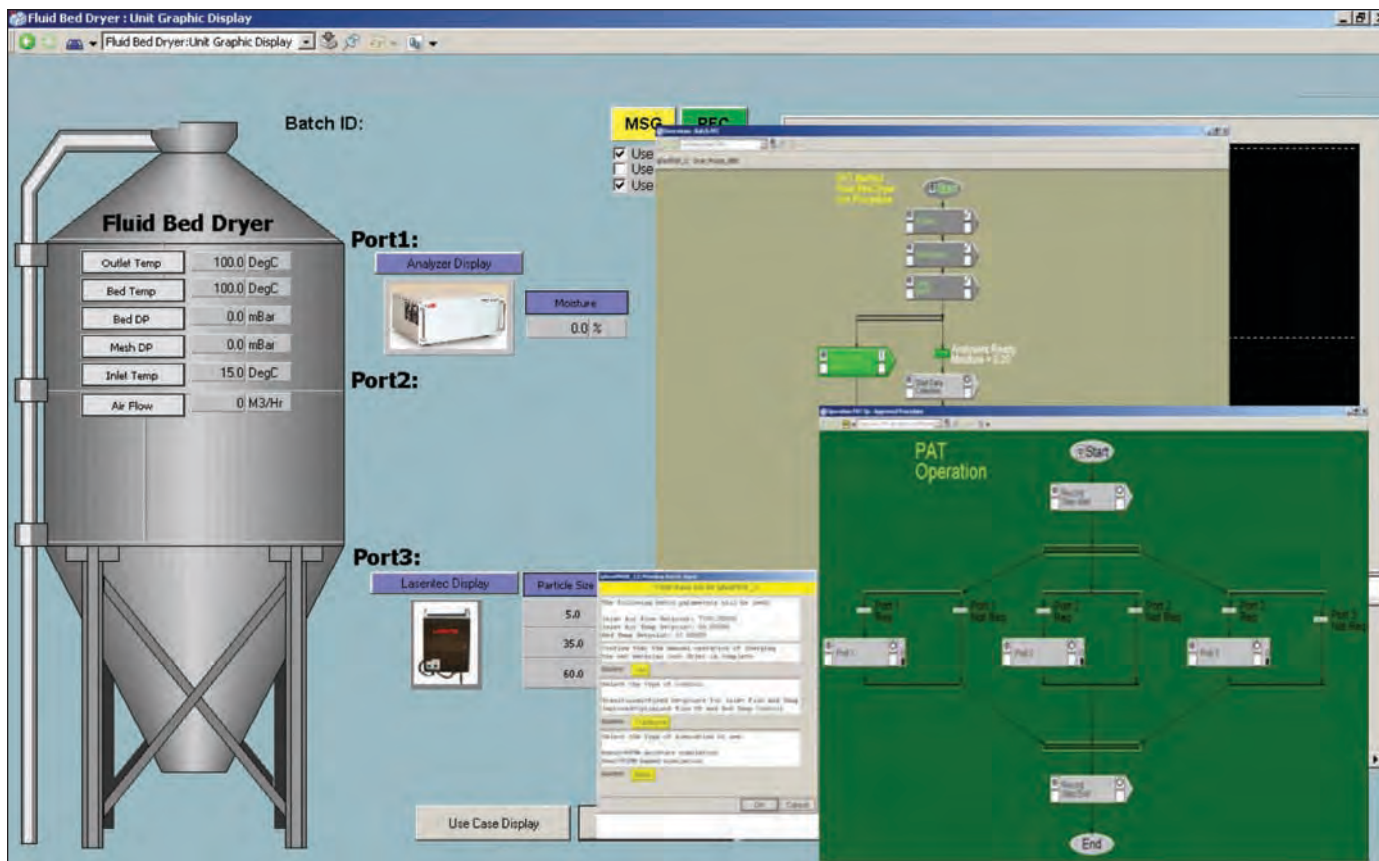

Figure 4. The graphic shows an operator control graphic with the unit procedure and the PAT method. The PAT method is embedded in the unit procedure.

in a data management system and the methods associated with the data are completed, a process model can be built using various tools available on the market. The goal of controlling the process is to identify the “control space” that defines the limit of the process system’s control capabilities and the “design space” for the process parameters that defines the limits of the process that must be observed to maintain the desired output. The goal is accomplished by measuring the CQAs and controlling the CPPs to maintain the system in a safe state, where the process parameters are well within the defined design space or window of constraint of the process. Setting up a well-managed data collection system, as mentioned above, delivers information that can be calculated from the data to provide a continuous state of monitoring and control of the process.

Visualization on the control system is used to view both the scalar and spectral data to assist operators and supervisors in defining where the process is located within the process’s “control space.” The integration of the Data Manager with the control system makes this visualization possible. This integration allows the operations staff to see the process data and its association with the CQAs that were previously defined for this process. It also allows for the monitoring and comparison of the process to that of a previously produced successful (“golden”) batch so that the exact recipe and procedure may be repeated - *Figure 3*.

Modern control systems can be configured to provide advance alarming capabilities or asset monitoring once the process is defined, modeled, monitored, and controlled. Asset monitors can take various inputs from the process and/or analyzers and record asset performance over the entire life span of the asset for comparison to a golden standard. Subsequently collected information can help managers set future performance and profitability goals. Using asset optimization programs with these asset monitors also can enable the plant to significantly reduce costly production interruptions by enabling predictive maintenance. When integrated with SMS and e-mail messaging, asset optimization provides a method for sending messages based on alarm and event information to chemometricians or application scientists via cell phones, e-mail accounts, and pagers. This process expedites the use of the data by system development personnel to improve the process.

In order to maximize flexibility for manufacturers and to have a standardized approach for this flexibility, manufacturers utilize the ISA-88 batch model to control the process. This ISA-88 model can be used for both continuous and batch processes. Even though a process is running continuously, there is a need to “track” lots of materials, utilities, and environmental and process conditions. This method allows an efficient way to do this plus optimizes date retrieval time. Using this approach increases product consistency, allows easy

*Continued on page 30.*



**Plascore Pharma™**

## Cleanroom Solutions

### Wall Systems and Walkable Ceilings

- Modular pharmaceutical wall and ceiling solutions.
- Demountable walls in progressive and nonprogressive options.
- Fully integrated doors and windows.
- Standard and custom finish options including painted, UPVC and stainless steel.

**Pharmaceutical**  
**Biotechnology**  
**Medical Research**  
**Life Sciences**





**PLASCORE®**

**Plascore, Inc.** 615 N. Fairview St., Zeeland, MI 49464  
 (800) 630-9257    sales@plascore.com    www.plascore.com



**CAL-CHEM CORPORATION**  
NOT JUST ANOTHER CONTRACTOR, BUT A PARTNER...

## “Follow Through”

“Follow Through” is critical in today’s technical market. Cal-Chem offers today’s industries solutions for a wide variety of precision cleaning and passivation, while preparing for tomorrow’s challenges.



visit our web site for more information: [www.cal-chem.com](http://www.cal-chem.com)  
 or call us at:

# 800-444-6786

Offices conveniently located on the East and West Coast

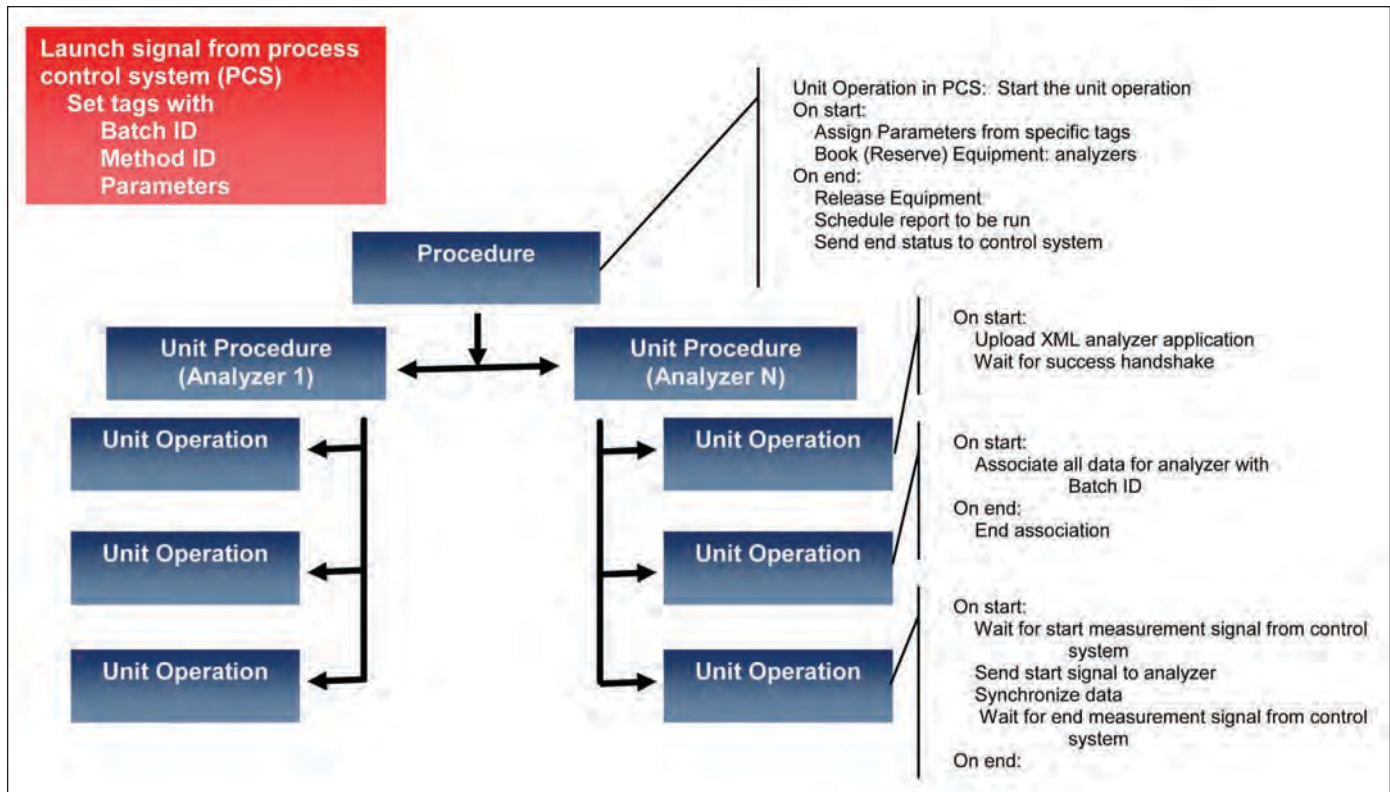

Figure 5. Example of complex PAT method in ISA-88 format.

to use recipe management operations, integrates production management functions, maximizes equipment utilization, and confirms regulatory compliance. Process batch management functions include product definition management, production execution management, production resource management, production data collection, and production dispatching.

The product definition management function includes information such as procedures, formulas, equipment requirements, and headers. This is the area of the ISA-88 model where the analyzer method can be integrated into the overall process. A procedure function chart is the graphical representation of a procedure - *Figure 4*. Each step of the procedure is displayed by a unique combination of colors and symbols.

For a process with spectrometer analyzers, there is a need to integrate the analyzer configuration step into the overall procedure. A field proven PAT method combines the analyzer configuration and batch procedure combined into one ISA-88 format file. A Process Control System (PCS) controls the execution of the PAT Method as the master control in the master/slave relationship between the control system and the PAT Method. This integration allows the control system to “book” the analyzer, download the method (parameters), confirm that the analyzer has the correct method installed, start the data collection, store the data, and end the data collection operation. Having an “end collection” operation to stop the collection of data when the process is completed reduces storage of unnecessary complex spectral data and increases the storage efficiency.

Storing the analyzer method with the lot data being collected from the analyzer eliminates any doubt as to which

method was used. All the data from the analyzers, the method(s) used, and the other process data associated with the lot (temperatures, pressures, flow, levels, pH, conductivity, TOC, etc.) will be stored in a batch folder associated with that lot that is located within the data management system. This batch record has a “software wrapper” around it that prevents changes to the data and provides easy access to the data via the system’s network or the plant or company’s intranet.

A simple PAT method is where one analyzer is used in a unit operation. A complex PAT method is where two or more analyzers are used in a unit operation or when stream switching is performed based on the product (recipe) that is being run. The modular nature of the ISA-88 format allows complex PAT methods to be easily integrated to complete the PAT solution - *Figures 5 and 6*.

An interface is required for each spectrometer analyzer integrated into the system. The communication between the system and the different analyzer components used to measure a process can be challenging. There are many different analyzers being used in the industry today, manufactured by various vendors, and using many different communication protocols integrated with many types of process control and information systems. Currently, there is no standard communication protocol for analyzers to match the standards that are available for other instrumentation, i.e., Profibus and Foundation Fieldbus. The OPC Foundation has responded to this challenge by recently starting a working group, OPC Unified Architecture – Analyzer Device Integration (OPC/UA – ADI)<sup>7</sup> to develop a standard for analyzer interfaces. Several analyzer manufacturers and end users are represented on

the team driving this effort to a standard protocol interface. In the meantime, a standard generic analyzer controller has been developed that allows all different types and brands of analyzers to communicate to the batch manager that is described above.

Completing the third step of the “learn, predict, and control” process allows the process to be continually adjusted to maintain a high level of quality based on the measured values and predictions generated in the first two steps. This is only possible after the process has been clearly understood, with all the variables known and the CQA’s reaction to changes in the system CPPs known so that it is possible to produce a product safely and efficiently by using closed loop control - *Figure 7*. Current closed loop control is set up so that the recipe management system controls the system CPPs by sending inflexible recipe setpoint parameters to the control system. With the proper PAT tools in place and properly set up, the system can monitor the process and modify the CPP values based on knowledge of the CQA’s reaction to the changes to adjust the process and keep it within the guidelines of the design space that was previously determined.

The PAT enabled control system adjusts the setpoints of the PID algorithm or phase logic that is embedded in each of the controllers to keep the process within the specifications of the design space rather than maintaining the recipe setpoint. The system continues to collect and model data from the laboratory and process analyzers (CQAs) and the process instrumentation as it is stored and time synchronized.

## Compliance with FDA Regulations

Any electronic data management application used in the life

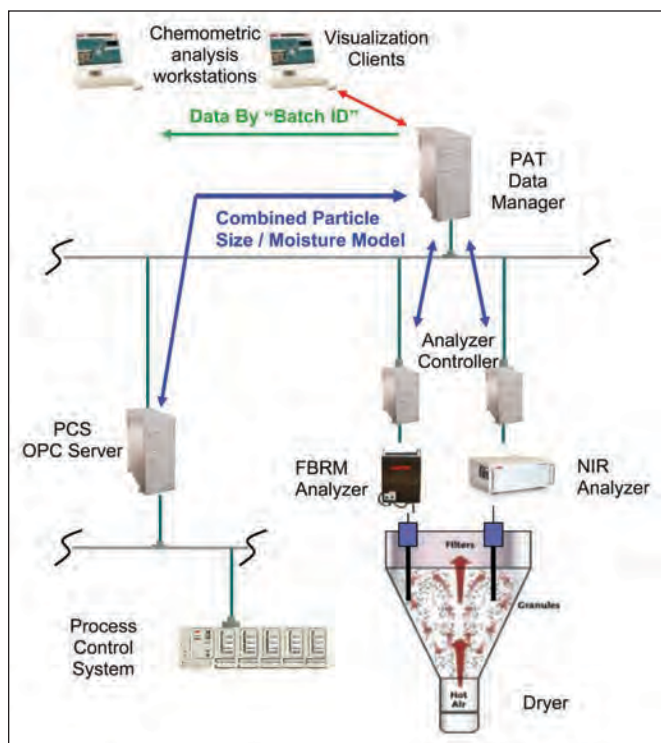

Figure 6. Example of complex data PAT solution with PAT Data Management Solution.

Continued on page 32.

Don't gamble on safety



## The safest sight glass is Metaglas®

Metaglas sight glasses are made by fusing true borosilicate glass inside a compressive metal ring. The result is glass uniquely resistant to failure and reusable after maintenance. If you're *not* using Metaglas, you're probably using the wrong type of glass and spending more on maintenance and reducing worker safety.

The #1 selling fused sight glass, Metaglas has been proven in thousands of plants. But it's L.J. Star's application experience that puts you in the winner's circle: You get the right solution and the right documentation, without the run around.

**Critical specs: USP Type I Glass, DIN 7079, DIN 7080, FM, ASME-BPE.**

**Find out why at [www.ljstar.com/SpecRite](http://www.ljstar.com/SpecRite)**



**Free Sight Glass Application Handbook**  
[www.ljstar.com/hb3](http://www.ljstar.com/hb3)

**L.J. STAR**  
INCORPORATED

**330-405-3040 • [www.ljstar.com](http://www.ljstar.com)**

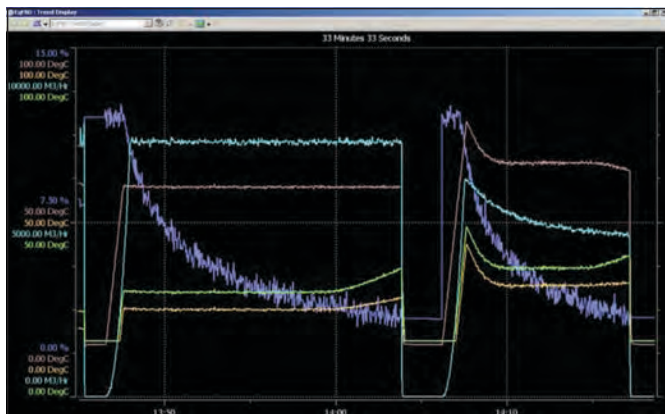

Figure 7. Trend display shows time elapsed during runs of a dryer, the first one without advanced model control, the second one with advanced model control.

science industry for GMP operation in a pilot plant or manufacturing facility must comply with the FDA requirement 21 CFR Part 11.<sup>8</sup> This regulation defines the use of electronic records and electronic signatures in the industry, including the role of validation, time stamps, copies of records, and record retention in the regulation. There are a number of software applications on the market today that can perform portions of complete PAT data management solution; however, each portion must comply with the applicable FDA predicate rule and 21 CFR Part 11, and the overall system also must comply. A system approach to PAT data management is the preferred approach due to ease of compliance, reduced cost of validation, single source responsibility of the supplier, ease of updates and upgrades, and the reduce cost of implementation.

Ease of validation is one of the major advantages of using a single system approach to data management. A system that uses a single database for data collection and data and metadata storage can be validated more easily than a system composed of multiple databases and software packages that have been integrated on a project-by-project basis. A system with multiple databases will have multiple interfaces, and each of these interfaces have to be qualified. Using today's technology to develop a single system that controls multiple classes of analyzers, performs data collection and data calculation functions, and has interfaces to external information technology and control systems can realize a significant savings in the cost and time spent validating the installation. This modular validation effort allows the reuse of the validation for the R&D and pilot plant applications in the manufacturing sites without extensive revalidation; a quick installation verification is all that is required to qualify the reused method. It also is possible to use analyzers that allow transfer (reuse) of calibrations between individual devices due to their tight manufacturing specifications.

## Benefits

There is no lack of information concerning the savings associated with using PAT. The petrochemical, pulp and paper, and electronics industries have been doing this type of automated adjustments to the processes for many years. Recently, the FDA

has asked the life sciences industry to perform the same process control. In addition, a series of guidance documents have been created by global regulators, including "Pharmaceutical cGMPs for the 21st Century," "PAT Initiative Framework," and "ICH Q8," as well as a renewed interface with industry groups such as ISPE, PDA, and IFPAC.

The ISPE PAT Community of Practice (COP) has a discussion thread on the ISPE Web site that contains various benefits from using PAT, including:

- better understanding of the process
- increased reproducibility from batch to batch
- reduced process risk
- reduced validation and revalidation effort
- reduction of scrap
- higher throughput

Using PAT is not limited to the manufacturing area. A complete PAT plan should include its use in R&D and pilot plant areas as well as in the manufacturing area. Ideally, PAT principles and tools should be introduced during the development phase.<sup>9</sup> The process understanding gained during the development phase of the product, including an understanding of process changes due to variables and raw material changes, can be transferred to pilot plant and manufacturing areas. This will allow the user to maximize these process benefits as they progress through scale up, testing, validation, and manufacturing phases.

With an integrated PAT data management program, qualified PAT methods can be transferred from one facility to another for identical processes. With some analyzers on the market, this also can include the calibrations of those analyzers.

## Summary

Advances in process analyzers and PAT data management systems make it possible to perform real time process control and online quality assurance during the R&D, pilot, and manufacturing phases of a product. This discussion covered several topics and various areas of a typical facility and the multiple disciplines needed to fully implement a PAT closed loop control system that delivers the most desired benefits. Storing data in a format and method that supports PAT implementation and use is not a simple task.

This discussion identifies that it is most useful when the PAT solution can be found in a single, scalable solution that interfaces with multiple types of analyzers, historians, and control systems, can support time synchronization, and store the PAT methods and data in a single batch file following an ISA-88 format that is compliant with current FDA regulations. A comprehensive PAT data management system must be in place to fully realize the benefits available from a full service PAT offering.

A PAT data management solution gives the user all the tools necessary for a PAT project. The results from a correctly set up PAT data management system allow understanding and optimization of the process. Having a system to provide

*Concludes on page 34.*



# True Sterile Connections **OUTSIDE** THE CLEAN ROOM<sup>SM</sup>



Patent Pending

## Pure-Fit<sup>TM</sup> SC

[www.biopharm.saint-gobain.com/true2](http://www.biopharm.saint-gobain.com/true2)

- A silicone valve design that avoids problems with paper pull-out systems (residual material in fluid path, gaps when paper is removed)
- Patented Pure-Fit<sup>®</sup> SIB<sup>®</sup> technology on barb connections to ensure a completely smooth inner bore flow path
- Ease of assembly
- A triple-redundant locking mechanism that virtually eliminates operator error

*Pure-Fit<sup>®</sup> and SIB<sup>®</sup> are registered trademarks.*

For more information on Pure-Fit<sup>®</sup> SC, visit [www.biopharm.saint-gobain.com/true2](http://www.biopharm.saint-gobain.com/true2) or call (800) 530-3419.

  
SAINT-GOBAIN  
PERFORMANCE PLASTICS

a common user interface and common method development tool for different types of analyzers enhances usability while reducing the system's training and long-term support costs.

Once the PAT data management solution is in place, the user will be able to understand where their process is within the control space and will be able to control it within the necessary limits. A fourth phase of a PAT project then can be added – continuous learning and optimization of the process based on the data. This understanding and optimization can result in increased yields and throughput, and reduce costs to support the ultimate goal in manufacturing: Real-Time Product Release (RTPR). All of these functions must be accomplished using software that can be configured to meet FDA regulations.

The FDA states that Real-Time Product Release can be enabled by PAT:

*“real time release is the ability to evaluate and ensure the acceptable quality of in-process and / or final product based on process data. Typically, the PAT component of real time release includes a valid combination of assessed material attributes and process controls. Material attributes can be assessed using direct and / or indirect process analytical methods. The combined process measurements and other test data gathered during the manufacturing process can serve as the basis for real time release of the final product and would demonstrate that each batch conforms to established regulatory quality attributes. We [FDA] consider real time release to be comparable to alternative analytical procedures for final product release.”<sup>10</sup>*

## References

1. Process Analytical Technology (PAT) is a system for designing, analyzing, and controlling manufacturing through timely measurements (i.e., during processing) of critical quality and performance attributes of raw and in-process materials and processes with a goal of ensuring final product quality as defined by Guidance for Industry PAT – A Framework for Innovative Pharmaceutical Development, Manufacturing, and Quality Assurance, FDA September 2004, <http://www.fda.gov/Cder/guidance/6419fnl.pdf>.
2. Wilhelm, R., Know Your Types of Standards, ASTM Standardization News, October 2000. Test Method – A definitive procedure that produces test result. A test method usually includes a concise description of an orderly procedure for determining a property or constituent of a material, an assembly of materials or a product. All details regarding apparatus, test specimen, procedure, and calculations needed to achieve satisfactory precision and bias should be included in a test method. An ASTM test method should represent a consensus as to the best currently available test procedure for use intended and it should be supported by experience and adequate data obtained from cooperative tests. Examples of test methods included, but are not
3. Buijs, T., “Process Analytical Technology: Integrated PAT solutions for the Life Sciences Industry,” ABB Review.
4. Guidance for Industry, Part 11, Electronic Records, Electronic Signatures – Scope and Application, FDA August 2003, <http://www.fda.gov/cder/guidance/5667fnl.pdf>.
5. Horizon MBTM FTIR Software User Manual (ABB May 2007).
6. ISA-88.01-1995 (R2006); Batch Control Part 1: Models and Terminology (ISA 2006), <http://www.isa.org/Template.cfm?Section=Standards8&Template=/customsource/isa/Standards/StandardsListing.cfm>.
7. OPC Foundation Announces Support for Analyzer Devices Integration into OPC Unified Architecture Platform (OPC Foundation, 12 January 2008, <http://www.opcfoundation.org/Search.aspx>).
8. Guidance for Industry, Part 11, Electronic Records, Electronic Signatures – Scope and Application, FDA August 2003, <http://www.fda.gov/cder/guidance/5667fnl.pdf>.
9. Guidance for Industry PAT – A Framework for Innovative Pharmaceutical Development, Manufacturing, and Quality Assurance, FDA September 2004, p. 13, <http://www.fda.gov/Cder/guidance/6419fnl.pdf>.
10. Guidance for Industry PAT – A Framework for Innovative Pharmaceutical Development, Manufacturing, and Quality Assurance, FDA September 2004, p. 12, <http://www.fda.gov/Cder/guidance/6419fnl.pdf>.

## About the Author



Mark Reed has more than 27 years of experience in automation system sales and design for pharmaceutical, biotech, chemical, and other industrial facilities. For the last 24 years, Reed has worked for ABB Inc. (previously Taylor Instrument and Combustion Engineering) as a Principal Account Manager specializing in automation systems for the life sciences and

chemical industries. ABB is one of the world's largest suppliers of process automation and building management systems, PAT, drives, robotics, analytics, instruments, and project services to the Life Sciences industry. Combining world-class products with deep application and industry experience, ABB helps customers achieve higher levels of operating efficiency, quality, and compliance. Reed has been actively involved with the successful introduction and sales of each of ABB's automation systems. Currently, he works with ABB's PAT Data Manager product and process analyzers to assist companies in realizing the benefits of using PAT and process analyzers. He graduated with a BS in chemical engineering from North Carolina State University in 1981. He is a member of ISPE and ISA. He can be contacted by telephone: +1-404-281-3543 or by email: [mark.reed@us.abb.com](mailto:mark.reed@us.abb.com).

ABB Inc., 940 Main Campus Dr., Suite 500, Raleigh, North Carolina 27606, USA. 

This article presents the transfer of a freeze-drying process from a glass bottle to a freeze-drying tray.

## Considerations for Transferring a Bulk Freeze-Drying Process from a Glass Container to a Tray

by Yves Mayeresse, Vinciane de Cupere, Romain Veillon, and Joseph Brendle

### Introduction

Freeze-drying, a leading drying technology, is widely used in the biopharmaceutical industry to stabilize products.<sup>1</sup> Although it is predominantly used for the storage of active ingredients before reconstitution into a final formulation, it also may be useful for some stages of intermediate production, such as Active Pharmaceutical Ingredient (API) operations.

A freeze-drying cycle may be divided into three stages.<sup>2,3</sup> First, the product is frozen at a sufficiently low temperature to reach a vitreous state where pure water has crystallized and the amorphous content remains in the interstitial region. In the second stage, the product undergoes sublimation at a temperature below the glass transition or collapse temperatures and crystallized water is sublimated. Finally, secondary drying is undertaken at a higher temperature to remove sorbed water from the interstitial region.

Maintenance of correct temperatures throughout the whole process is essential. Indeed, if the product temperature rises above the collapse temperature<sup>1</sup> (maximum temperature allowed during the freeze-drying process to keep

physical structure integrity of the cake), the product viscosity is lowered and an irreversible melting may occur.

Such a collapse can result in the rejection of a partial or total batch.

Initial freezing of the product involves two steps: ice nucleation followed by ice crystal growth. Once the solidification temperature is reached, all other elements of the formulation are typically rendered an amorphous solid.

The sublimation phase is an endothermic process which is controlled predominantly by shelf temperature and chamber pressure. Numerous other factors (such as container heat transfer coefficient, container geometry, stopper design, freeze-dryer geometry, freezing behavior, fill depth, formulation type and concentration, and the robustness of the filling process) also are important and together contribute to the product temperature at the interface where the water crystals sublimate. The product temperature is kept below collapse temperature with a safety margin during the whole cycle. At the end of this stage, products with conforming visual aspect and homogeneous moisture content are obtained. The high number of parameters influencing this process explains why it is so difficult

Reprinted from  
**PHARMACEUTICAL  
ENGINEERING®**  
The Official Magazine of ISPE

March/April 2009,  
Vol. 29 No. 2

©Copyright ISPE 2009  
www.ISPE.org

Figure 1. Product weight profile during freeze-drying using a microbalance, at the end of primary drying (48 hours), moisture content is 12%, at the end of secondary drying (60 hours), moisture content is 1.3%.

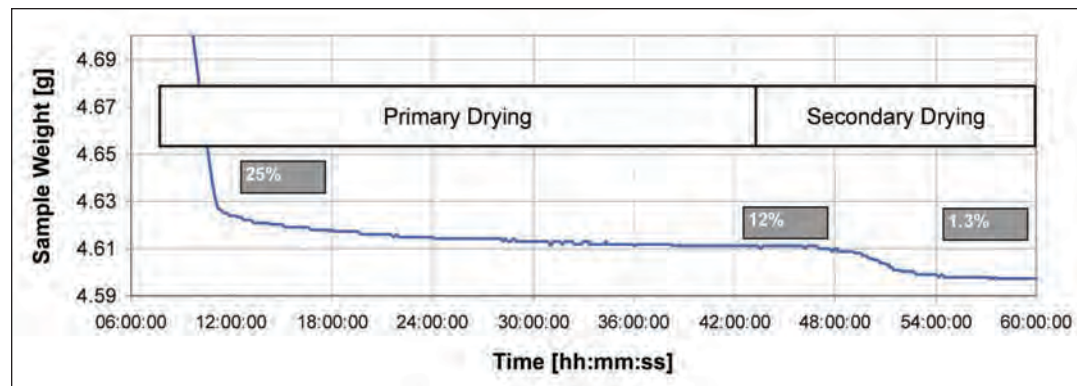

Continued on page 38.

Work continued from Page

Freeze-drying = open system  
ICH Q1A → closed better than open  
Is there a way to do closed freeze-drying?

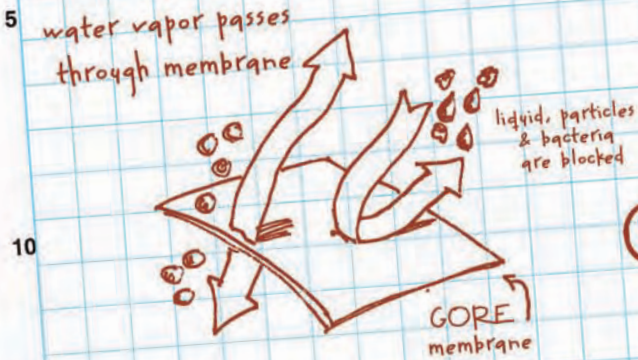

-Engineering controls  
-Sterile API

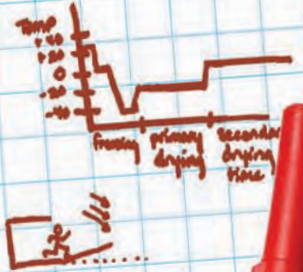

$$\frac{dm}{dt} = \frac{(P_0 - P_1)}{(R_p + R_m)}$$

$$\frac{dQ}{dt} = A \Delta T_o P$$

Increased area = increased heat transfer

Single use solution for freeze-drying.

Lyoguard



1050.002 F  
1050.002M

25 Why can't an open system be... closed?

Freeze drying systems are traditionally open. But GORE™ LYOGUARD® freeze drying products are closed. How? Our patented membrane material can breathe. So this closed system contains your product, cutting down risks of product contamination and cross contamination. Worker safety is improved, and yields are increased due to minimal product loss and optimized operations. And the single use product form reduces cleaning and cleaning validation. Open and closed. So you can pursue your boldest innovations. Find out more at [gore.com/pharmbio](http://gore.com/pharmbio).

Gore PharmBIO Products      Tubing. Membranes. Filtration. Creativity.

30

35

SIGNATURE \_\_\_\_\_ DATE \_\_\_\_\_ WITNESS \_\_\_\_\_

DISCLOSED TO AND UNDERSTOOD BY \_\_\_\_\_





Figure 2. One liter glass bottle after freeze-drying with a fill weight of 400ml.

to model the freeze-drying process. After primary drying, 10 to 20% water remains adsorbed on the active ingredient within the formulation. Therefore, a secondary drying step, often called desorption, is undertaken to remove this bound water - *Figure 1*.

During this phase, the shelf temperature ramp needs to be well designed to avoid local product collapse and shrinkage as a result of local overheating. However, once the plateau is reached, the product is maintained at this positive temperature for several hours to obtain the right residual moisture level. At this stage, water removal is achieved by diffusion, rather than sublimation. Since diffusion kinetics is slower, the secondary drying may take up to one third of the entire process duration, despite only removing 10 to 20% of the total water. The maximum temperature for secondary drying is defined by the function of the ultimate product; however, for biopharmaceutical molecules, it usually remains below +40°C.

Cycle optimization is undertaken to design a cycle with the highest allowed product temperature and sufficient safety margins, such that despite any variations, the product will be maintained within proven acceptable limits. In the past, freeze-drying cycle optimization mainly consisted of a trial and error approach, until a satisfying cycle was reached. Today, a process evaluation and validation approach is used. Evaluation of the freeze-drying process is initially undertaken and considers composition description, glass transition studies, and the lyophilization cycle time. The critical parameters (e.g., shelf temperature) are then established, quality attributes are described (i.e., potency, residual solvent, humidity) and the proven acceptance range is set (i.e., shelf temperature  $\pm 3^\circ\text{C}$  or  $\pm 5^\circ\text{C}$ ). Finally, validation of the proven acceptance range is accomplished (input parameters) by measuring the quality attributes (output parameters).

Mapping industrial equipment operational capabilities (i.e., ice condenser capacity) also is critical in order to evaluate potential process limitations during scaling up. Another factor that needs to be taken into account is the scheduling of the manufacturing operations. For example, there is no need to design a cycle that stops at 3:00 am when working scheduling is not in three shifts. Indeed, an integrated approach to take into account both scientific and business needs to be adopted.

The global process concerns an intermediary of production that does not need to be filled in aseptic condition. After freeze-drying, the membrane trays are readily transferred in a glove box with controlled humidity. Then the content of the membrane trays are transferred in glass bottle for long term storage.

Traditionally, we have performed our freeze-drying cycles in 1 liter glass bottles. We describe here a feasibility study which was undertaken to evaluate the compatibility of ePTFE



Figure 3. Membrane tray used for freeze-drying with a fill weight of 1.7L

membrane trays with our water and organic solvents formulation. We used our preliminary results as the starting point for developing a new freeze-drying cycle adapted to a membrane tray and a different freeze-dryer. Single-use ePTFE membrane trays were selected instead of more traditional stainless steel trays for several reasons including: eliminating the need for cleaning and cleaning validation of re-usable trays and reduced product fly-out. However, the process transfer principles described here also could be applied to stainless steel trays with proper adjustments in the calculations.

## Materials and Methods

The main equipment used in the processes were: 1 liter glass bottles (Figure 2), membrane trays (Figure 3), and three different freeze-dryers.

### Non-Optimized Process Evaluation

Our traditional freeze-drying process, which was undertaken in 1 liter glass bottles with a fill volume of 400 ml, was first characterized according to freezing time, primary drying cycle length, and glass integrity.

### Cryomicroscopy

Cryomicroscopic studies were performed at different freezing speeds (0.5; 1.0; 5-10°C/min) to evaluate the best freezing rate conditions for our product. In our study, the presence of the organic solvent in the formulation induced unusual crystal shapes and sizes - *Figure 4*.

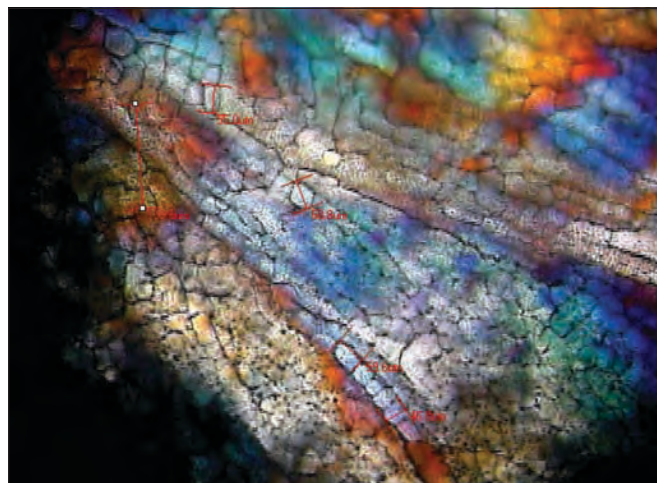

Figure 4. Freezing study using cryomicroscopy to evaluate ice crystal size in relation to freezing rate.

*Continued on page 40.*

# Intelligen Suite

The Market-Leading Engineering Suite for Modeling, Evaluation, Scheduling, and Debottlenecking of Single & Multi-Product Facilities

## SuperPro

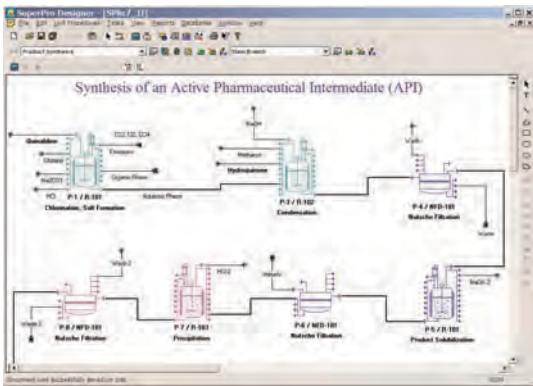

## SchedulePro

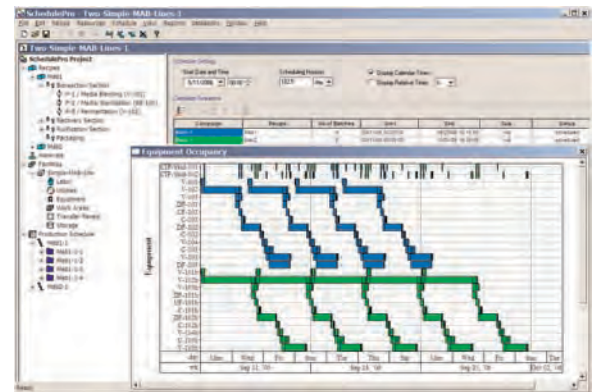

Use SuperPro Designer to model, evaluate, and debottleneck batch and continuous processes

Switch to SchedulePro to schedule, model, and debottleneck multi-product facilities



Tracking of equipment occupancy in multi-product facilities

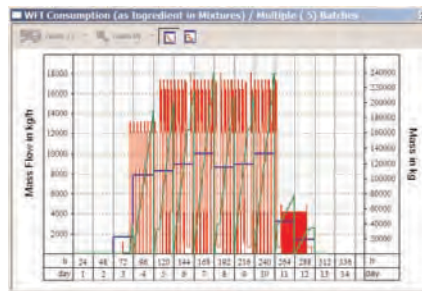

Tracking demand for resources (e.g., labor, materials, utilities, etc.)

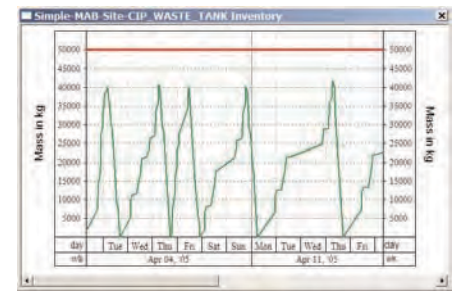

Inventory tracking for raw materials, intermediates, products, and wastes

**SuperPro Designer** is a comprehensive process simulator that facilitates modeling, cost analysis, debottlenecking, cycle time reduction, and environmental impact assessment of biochemical, specialty chemical, pharmaceutical (bulk & fine), food, consumer product, mineral processing, water purification, wastewater treatment, and related processes. Its development was initiated at the Massachusetts Institute of Technology (MIT). SuperPro is already in use at more than 400 companies and 500 universities around the world (including 18 of the top 20 pharmaceutical companies and 9 of the top 10 biopharmaceutical companies).

**SchedulePro** is a versatile finite capacity scheduling tool that generates feasible production schedules for multi-product facilities that do not violate constraints related to the limited availability of facilities, equipment, resources and work areas. It can be used in conjunction with SuperPro (by importing its recipes) or independently (by creating recipes directly in SchedulePro). Any industry that manufactures multiple products by sharing production lines and resources can benefit from the use of SchedulePro. Engineering companies use it as a modeling tool to size utilities for batch plants, identify equipment requirements, reduce cycle times, and debottleneck facilities.

**Visit our website to download detailed product literature and functional evaluation versions of our tools**

**INTELLIGEN, INC. • 2326 Morse Avenue • Scotch Plains, NJ 07076 • USA**

**Tel: (908) 654-0088 • Fax: (908) 654-3866**

**Email: [info@intelligen.com](mailto:info@intelligen.com) • Website: [www.intelligen.com](http://www.intelligen.com)**

**Intelligen also has offices in Europe and representatives in countries around the world**

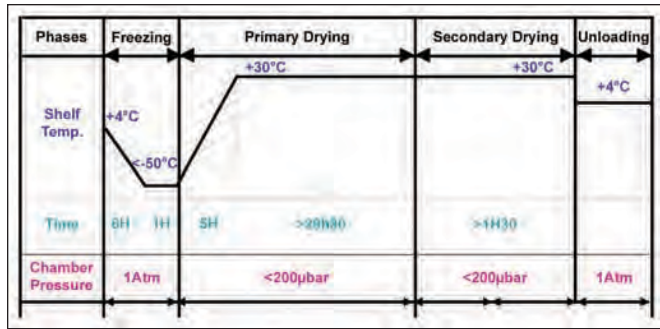

Figure 5. Lyophilization Cycle A - in blue, the temperature cycle, in pink, pressure cycle.

In contrast to normal observations, water crystal size decreased during slow freezing and increased during quick freezing. These findings influenced the selection of the lyophilization cycles during new process evaluation.

## New Process Evaluation Membrane Trays

In order to validate the compatibility of the membrane tray in the presence of an organic solvent, extractible and leachable studies were performed following USP and EP guidelines.

### Lyophilization Cycles

Early lyophilization cycles using membrane trays were developed for a total load of 20 liters and process duration of approximately two days. As a result of the cryomicroscopic studies, the freezing step involved the introduction of the membrane tray at 0°C and slow freezing down to -50°C over six hours, to allow for the formation of smaller crystals. Two cycles were evaluated:

#### Cycle A

The membrane tray was introduced at 0°C and held at this temperature for sufficient time to allow the product temperature to equilibrate. Slow cooling was undertaken at a rate below 0.5°C per minute until the temperature reached at least -45°C. The shelf temperature was ramped to a maximum of +30°C over five hours at a pressure below 200 µbars and was held under these conditions for 29 hours and 30 minutes. The total cycle duration was at least 43 hours - *Figure 5*.

Several problems were encountered with cycle A. First, the membrane trays inflated during the course of lyophilization, particularly at the beginning of the sublimation step. This attributed to excessive vapor flux affecting membrane permeability. Second, long strips of wet powder were observed at the bottom of the cake, at the end of lyophilization, indicating that large ice crystals had formed during freezing step and that sublimation was not complete.

In order to avoid the formation of large ice crystals and to slow down the sublimation event, the freezing time was reduced by introducing the sample directly onto a pre-cooled shelf, the primary drying temperature was decreased, but the duration increased and a secondary drying phase was introduced.

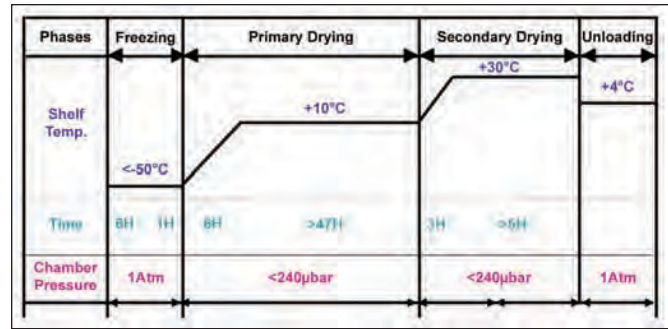

Figure 6. Lyophilization Cycle B - in blue, the temperature cycle, in pink, pressure cycle.

#### Cycle B

The membrane tray was introduced onto a pre-cooled shelf below -45°C and held at this temperature for five hours. The shelf temperature was ramped from -50°C to +10°C over six hours with vacuum controlled at a setpoint below 240 µbars. The shelf temperature was held for at least 47 hours at a maximum of +10°C and a pressure below 240 µbars. Secondary drying was undertaken by ramping from +10°C to maximum +30°C over three hours at a pressure below 240 µbars and holding under these conditions for at least five hours. The total duration of the cycle was 67 hours - *Figure 6*.

#### Validation

The reproducibility and robustness of the lyophilization process were tested by subjecting one batch of product to five different lyophilization cycles, comprising three standard cycles of process b for reproducibility and two extreme cases for robustness.<sup>5</sup> The extreme cases comprised faster drying (target pressure +20%; target temperature +5°C; duration 54 hours) and slower drying (target pressure -20%; target temperature -5°C; duration 40 hours). The different lyophilization cycles were compared by analyzing the organic solvent and residual water content of the end product.

#### Product Homogeneity

As the condensers are situated in the lyophilization chamber,

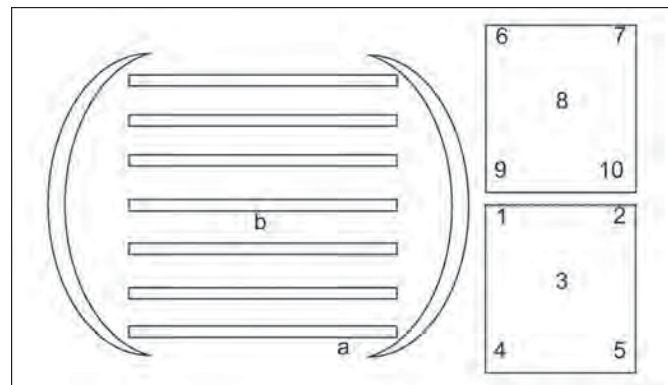

Figure 7. Description of the samples taken in order to determine the homogeneity of the bulk produced in one lyophilization cycle. Position of the membrane trays in the freeze-drying chamber: on first shelf next to the condenser (membrane tray a); on the middle of the fourth shelf (membrane tray b). Sample points in each membrane tray (1 to 10).

*Continued on page 42.*



# In safe hands

## Containment Solutions for the Pharmaceutical & Biotech Industries

- Barrier Isolation Systems
- Downflow Containment Booths
- High Containment Screens
- Pack Off and Process Equipment
- Kilo Labs & Glassware Enclosures



For further information please contact us on

North America

502 968 2065

Rest of the World

+44 (0) 1204 571131

[info@howorthgroup.com](mailto:info@howorthgroup.com)

[www.howorthgroup.com](http://www.howorthgroup.com)



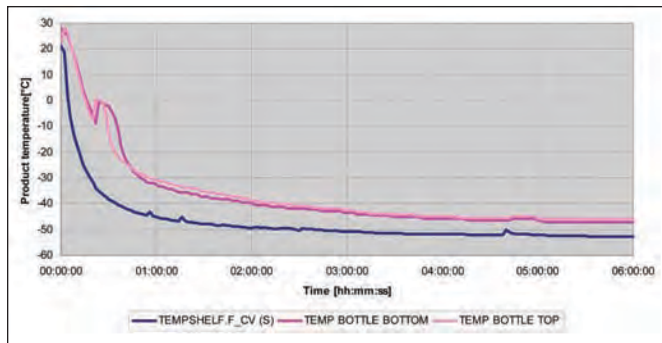

Figure 8. Product temperature profile during freezing in large bottles.

radiation may induce a temperature gradient from chamber center to its periphery, which may ultimately cause water and organic solvent content heterogeneity within the lyophilized cake. In order to test for homogeneity, samples from a single batch were removed from membrane trays placed on the lowest and middle shelves of the lyophilization chamber (i.e., closest to the condenser at the coolest part and at the warmest part of the chamber, respectively - *Figure 7*).

## Freezing Conditions

The effects of rapid and slow freezing were compared on the same bulk by loading parts of the lot on freeze-dryer shelves at two different temperatures (0°C and -45°C). The end products were analyzed with respect to organic solvent content, using a moisture testing device, and product particle size.

## Results

### Non-Optimized Process Evaluation

#### Freezing Time

The freezing process in large bottles on pre-cooled shelves was long; taking two and six hours to reach -40°C and -45°C, respectively - *Figure 8*.

This extended freezing time was predominantly due to bottle geometry, which results in a poor capacity for the first ice layer to dissipate the water crystallization exotherm.

#### Primary Drying Cycle Length

The freeze-drying cycle time using glass bottles was 160 hours - *Figure 9*. The product temperature from the vial bottom reached positive temperature after 140 hours indicating the end of the sublimation endotherm.

#### Glass Integrity – Lensing

When a product is freeze-dried in large bottles, there is a tendency for the bottle bottom to weaken as a result of freezing and subsequent ice expansion, resulting in a lens shaped fracture. During stoppering, the fragile glass released tension by cracking or fully breaking in a lens shape.

### New Process Evaluation

#### Membrane Trays

An analysis of the leachable and extractables studies done following the USP and EP guidelines showed that the trays were suitable for this application. This portion of the new

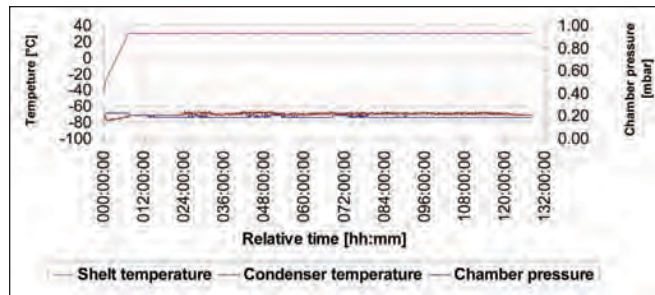

Figure 9. Freeze-drying process recording during a week cycle with large bottles, the shelf temperature is in pink, the condenser in brown, and the pressure in blue.

container validation was a time consuming process, taking over 200 working hours.

## Lyophilization Cycles

### Cycle A

As seen from the temperature recordings, at the end of the primary drying phase (after 42 hours), the cake temperature did not reach a plateau approximating to shelf temperature - *Figure 10*.

In addition, there was a discrepancy between the target chamber pressure and the effective pressure, indicative of excessive vapor flux at the beginning of the sublimation process.

### Cycle B

As seen in *Figure 11*, the sample temperature reached a plateau before the end of the primary drying sequence, indicating that the ice had been completely sublimated out of the sample before the secondary drying sequence commenced. In addition, there was no discrepancy between the set-up and real chamber pressure measurements. No membrane tray inflation was observed using this cycle.

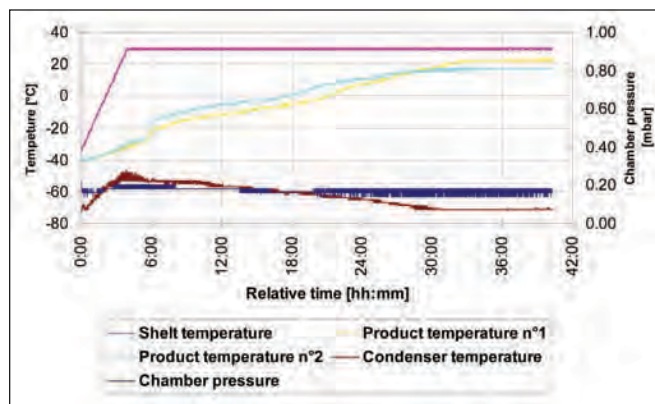

Figure 10. Lyophilization cycles (a). In pink, shelf temperature; in yellow and blue, the measured sample temperature (at the middle and at the top of the cake); in dark blue, the measured pressure, in brown, the measured condenser temperature. During lyophilization cycles illustrated in A, sample temperature hardly reached a plateau value after 42 hours, indicating that lyophilization was not completely finished (primary drying: OK, secondary drying: absent). During the lyophilization cycle illustrated in 14b, real pressure value was higher than the set value. This indicates an excessive vapor flux, at least during the first 10 hours of the primary drying.

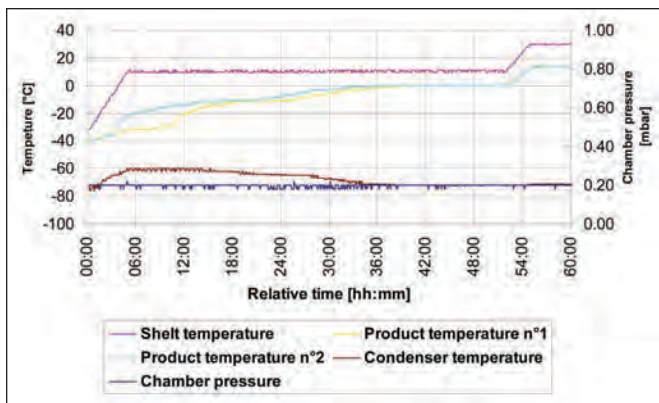

Figure 11. Lyophilization cycles (b). In pink, shelf temperature; in yellow and blue, the measured sample temperature (at the middle and at the top of the cake); in dark blue, the measured pressure, in brown, the measured condenser temperature.

## Validation

The residual water content for the three reproducibility lots was identical (5.3%) - Table A. The values were slightly higher after slower and faster drying, respectively (5.7% and 5.2%).

The organic solvent contents were within specification after all processes, illustrating process robustness. Both the improved and standard drying cycles provided the same results for organic solvent content, indicating that the drying process is complete (i.e., no more free organic solvent in the

	Sample	Res. Sol. wt%	Water wt%
repro	Pool 9/41/RO	5.3	3.7
	Pool 9/41/RO run2	5.3	4.45
	Pool 9/41/RO run3	5.3	4.62
worst case (dry)	Pool 9/41/RO-run 4	5.2	4.22
worst case (wet)	Pool 9/41/RO-run 5	5.7	4.17

Table A. Results of validation in terms of water content and residual solvent.

bulk) after the standard cycle. Any remaining organic solvent in the product is present in product salt.

## Product Homogeneity

Organic solvent and water content were consistent in both membrane trays, irrespective of their position in the lyophilization chamber (Table B), indicating that the lyophilization process is homogeneous, and allowing for random quality control sampling from any of the membrane trays.

## Freezing Conditions

Irrespective of the shelf temperature, both samples displayed organic solvent content of 5.6% and KF values ranged from 0.8 to 0.9 %. The product particles size distribution showed that there was no significant difference between the two samples. The particle size distribution is described for both

*Continued on page 44.*



ARCHITECTURE  
ENGINEERING  
CONSTRUCTION

S I N G L E   S O U R C E   R E S P O N S I B I L I T Y

## From Benchtop to Distribution

### We Understand Your GxP Facilities.



Research

API

Manufacturing

Finishing

Support



8 Ridgedale Avenue, Cedar Knolls, NJ 07927 – 973-775-7777  
Contact: [guy\\_cipriano@eiassociates.com](mailto:guy_cipriano@eiassociates.com) – ext. 378



## DELABELING SOLUTIONS

for

- SYRINGES\*
- CARTRIDGES
- GLASS VIALS
- PLASTIC VIALS
- METAL CANISTERS

\*new 2009

Information:  
[www.hurstcorp.com](http://www.hurstcorp.com)

Other HURST products:  
Automatic vial TrayLoaders,  
plastic vial trays and custom made  
stainless steel products.



**HURST CORPORATION 610-687-2404**  
Box 737 - Devon, Pennsylvania 19333 - USA

	Sample	Res. Sol. wt%	Water wt%
a	Pool 17/41/RO-1	6.0	0.1
	Pool 17/41/RO-2	6.0	0.1
	Pool 17/41/RO-3	5.9	0.1
	Pool 17/41/RO-4	5.8	0.1
	Pool 17/41/RO-5	6.1	0.2
b	Pool 17/41/RO-6	5.9	0.1
	Pool 17/41/RO-7	6.0	0.3
	Pool 17/41/RO-8	5.9	0.3
	Pool 17/41/RO-9	6.0	0.3
	Pool 17/41/RO-10	5.9	0.3
	mean	6.0	0.2
	stand dev	0.08	0.10

Table B. Result obtained from the sampling described in Figure 7.

samples in Table C by the d(0.1), d(0.5), and d(0.9) which are respectively the maximum size of the first 10%, 50%, and 90% of the distribution. These results indicate that when undertaken within acceptable limits, freezing conditions do not significantly impact on product quality.

## Discussion

There are numerous published articles discussing heat and mass transfer.<sup>6,7,9,10,11,12</sup> Here we will use the basic concept of heat and mass transfer to explain our observations regarding a process modification from freeze-drying in a glass bottle with a high fill depth, to a plastic tray with a low fill depth.

Mass transfer reflects the quantity of water vapor sublimated in unit time by a specified surface. Different flow regimens (viscous, transition, and molecular) are defined, which are governed by different equations representing different physical situations. The selection of the correct flow regimen is linked to two parameters: the mean free path [average distance of a specific molecule (water or nitrogen) between collisions] and the dimension characteristics of the system. The lower the pressure, the higher the mean free path ( $\lambda$ ) and within the lyophilization pressure range,  $\lambda$  ranges between centimeters to meters. Collisions can occur between two molecules (if there are many molecules or a high chamber pressure) or between a molecule and the chamber wall (if the distance between two walls is small or if there are only few molecules).

Mass transfer can be rate limiting in certain situations,<sup>8</sup> and in our new process, a semi-permeable membrane with a small pore size was added between the interface and the condenser. In addition, filling depth was reduced by a factor 7 in the two different types of container. Filling depth has a major impact on sublimation time ( $T_s$ ; Figure 12), as seen in the following equation, where the filling depth ( $d$ ) is taken into account three times:<sup>1</sup>

	d (0.1) ( $\mu\text{m}$ )	d (0.5) ( $\mu\text{m}$ )	d (0.9) ( $\mu\text{m}$ )
slow freezing	32.125	102.207	206.507
rapid freezing	28.548	95.527	195.108

Table C. Measurement by SLS of particle size distribution in bulk powders obtained after lyophilization with fast freezing (a) and slow freezing (b).

$$T_s = (\rho \cdot w_1 \cdot \Delta H_s \cdot w'_1 \cdot d) / [(1/K_v) + (\kappa \cdot d/2) + (\Delta H_s \cdot \omega \cdot d/2)]$$

Where:  $d$  = fill depth [m]

$\rho$  = density of the frozen solution [kg/m<sup>3</sup>]

$w_1$  = total water content [kg/kg]

$\Delta H_s$  = is the latent heat of sublimation [J/kg]

$w'_1$  = mass fraction of ice, often taken to 0.9

$\kappa$  = thermal conductivity of the frozen solution [kJ/°C.m.h]

$K_v$  = heat transfer coefficient from the shelf fluid to the sublimation interface

$\omega$  = water mass transfer [kg/h.m.Pa]

Many different resistances to mass transfer may be encountered during a freeze-drying cycle, including the sublimation interface, dried layer, and headspace both in the container and toward the condenser. At the sublimation interface, water molecules with sufficient energy are projected upward to compensate for the lower quantity of vapor molecules in the gas phase. The total pressure (water and gas) defines the likely quantity of water molecules that will escape. The sublimation interface starts at the top of the vial, and moves downward as the process progresses. The dried layer, in correlation, increases above the interface as drying progresses and after a few hours a network of channels (the size of which is pre-determined by freezing conditions, the product, and other factors) will lie above the interface. It will be more or less difficult for water molecules to flow out of this layer depending upon the openness of the network of channels. Once water molecules have escaped the dried layer, their progress will be restricted by the stopper or semi-permeable membrane, which creates a restricted pore size, and resultant 'traffic jam' of molecules before the opening. This accumulation of molecules can result in a local increase in partial pressure.

Freeze-dryer geometry affects water flow to the condenser, where a two-chamber system creates an additional restriction to passage - *Figure 13*.

Indeed, the surface area of the condenser and its temperature influence the condensation capacity of the freeze-dryer. Molecule transition to the condenser is achieved through a pressure gradient produced by the difference in water-vapor partial pressure of the water vapor molecules and low-temperature ice on the condenser surface. This gradient is maintained by the heat removal capacity of the ice condenser. The refrigeration system determines the maximum allowable condensation rate for the water molecules.

Although mass transfer limitations may occur when the freeze-drying cycle is too short for the mass capacity of the product, container, or freeze-dryer nominal condensing capacity, most of freeze-drying processes are more limited by heat transfer than mass transfer.

Three types of heat transfer operate during freeze-drying: conduction, convection, and radiation. Conduction occurs when two molecules have direct contact. Although at a microscopic level, there are only a few contact points between the bottom of a container and the shelves, during freeze-drying, conduction predominantly occurs inside the glass or plastic surface and the frozen layer. Convection is the transfer of energy between

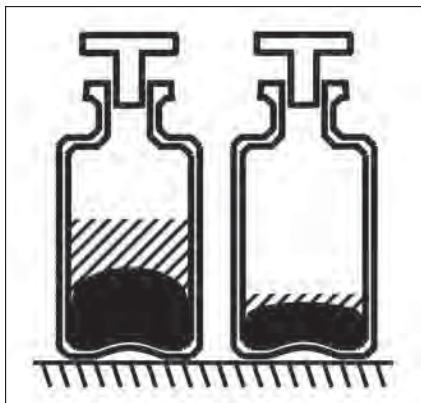

Figure 12. Impact of filling height on sublimation time. Upper part (dashed) is the freeze-dried material and bottom part (black) is the frozen part.

two surfaces through an intermediary fluid (for example air conditioning). Although at the pressures used during freeze-drying, the numbers of molecules present is reduced by a factor of at least 10,000, and the term 'convection' may become inappropriate, the transfer of heat is largely achieved by the remaining water or nitrogen molecules between the shelf and the product. Radiation is the transfer of energy by atoms or molecules, following thermal excitation. The radiant energy can be calculated using the Stefan-Boltzmann law. During freeze-drying, the main sources of radiation are shelves, walls, and the freeze-dryer door. Heat transfer through conductivity only occurs at the bottom of the vial or tray, but convection and radiation occur throughout the container with an intensity related to the composition and geometry of the container.

Heat and mass transfer link at the interface, where energy is transferred to surface molecules. Those molecules with sufficient kinetic energy escape from the interface, resulting in the reduction of the average temperature of

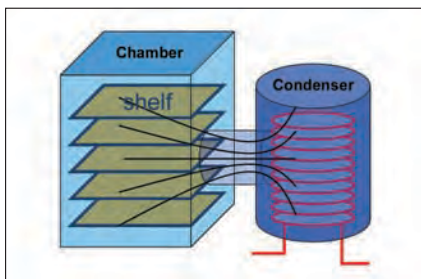

Figure 13. Water vapor mass transfer within a freeze-dryer showing a restriction between chamber (product) and condenser.

the remaining solution (the endothermic effect resulting from sublimation).

By taking the different types of heat and mass transfer into account and assigning specific values in mathematical models, the behavior of a freeze-dried product in terms of heat and mass transfer can be predicted.<sup>8,9</sup> Therefore, we have used these models to review the main differences between our two processes (bottle and ePTFE tray).

In order to achieve the defined product

characteristics, quick freezing is better than slow freezing. Inside a 1 liter glass bottle, sub-cooling may occur at first, but after crystallization, the exotherm is hardly evacuated because of the poor thermal conductivity of ice. As a result, there is not enough stored energy to obtain a quick cooling effect. In addition, the cooling energy from the shelves has a long distance to reach the surface of the liquid in the bottle, which results in a system with a mixture of small and

*Continued on page 46.*

## Reliable solutions for sterile applications



## GEMÜ - your first choice for stainless steel diaphragm valves

- **Hermetic sealing - EHEDG certified**  
 The original GEMÜ diaphragm seal system, minimum deadleg, reliable sealing even with abrasive particles
- **Exceptional service life and high reproducibility**  
 Filling, mixing, separating – and easily sterilised (SIP) and cleaned (CIP)
- **Eminently suitable for automation and control systems**  
 Positioners, position indicators, combi switchboxes, field bus solutions and more
- **Wide selection of valve bodies and configurations**  
 The largest selection of valve bodies, T-valves, tank valves, valve clusters, multiport blocks and customized solutions

**GEMÜ®**

GEMÜ Gebr. Müller Apparatebau GmbH & Co. KG · Fritz-Müller-Str. 6-8 · D-74653 Ingelfingen  
 Phone 07940/123-0 · Telefax 07940/123-224 · info@gemue.de · www.gemue.de

	Cost per Content [%]	Liter per Content [L]	Used Shelf [n]	Content per Shelf [n]	Maximum per Load [n]	Liter per Load [L]	Cycle Time [hours]	Capacity per Week [L/week]
Bottle	40	0.4	2	12	24	9.6	160	9.6
Lyoguard	100	1.7	5	4	20	34	72	68

Table D. Business case comparing freeze-drying capacity between current bottle production and lyo trays process. Cost is a percentage, Membrane tray taken as 100%.

large ice crystals, which is more difficult to freeze-dry. In the membrane tray, a large surface is in contact with the cooled shelves, and energy continues to be applied at a good rate even after system crystallization. The heat transfer rate ( $Q_s$ ) from shelf through the bottom wall of the tray during freezing conduction can be calculated using Fourier's law:

$$Q_s = A \cdot \lambda \cdot (T_p - T_s) / \delta$$

Where: A = surface of the tray [m<sup>2</sup>]

$\lambda$  = thermal conductivity of the tray [W/m.K]

$\delta$  = thickness of the bottom of the tray [m]

$T_s$  = the temperature of the shelf surface [°C]

$T_p$  = the temperature of the internal bottom surface of the tray [°C]

The heat transfer rate is increased when the surface and thermal conductivity are maximized and thickness is minimized. Although one study demonstrated that in a 1 liter glass bottle, a high fill depth was not associated with a decrease in mass transfer throughout the dried layer during primary drying,<sup>7</sup> these results were specific to one product under particular freezing conditions. Usually, the slow heat transfer through the glass and the frozen layer results in a seven day cycle, despite raising the temperature of shelves aggressively, because the contact surface between the flat bottom of the glass bottle and the shelf is minimal. Heat transfer efficacy (radiation and convection by gas through lateral walls) is also decreased by the large distance to the middle of the bottle [5 cm for a cylinder of 400 ml in a 1 liter bottle]. During secondary drying, more energy is required by the product in order to desorb the bound water and a similar heat transfer limitation will result in a longer time for this phase. Therefore, in order to obtain the same residual moisture as with tray containers, the bottle process requires more energy.

Another issue was lack of homogeneity associated with large bottle freeze-drying. It was observed that using the 1 liter glass

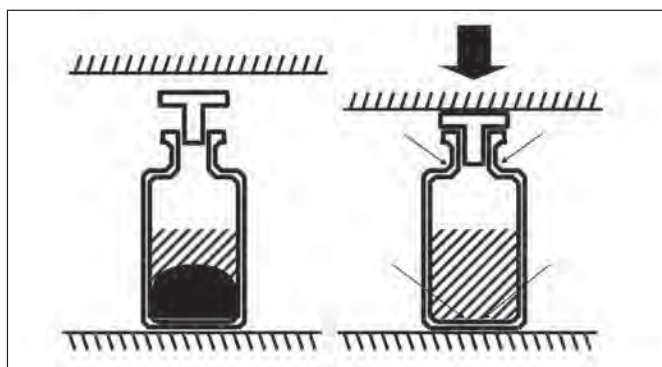

Figure 14. Representation of stoppering force on bottle side.

bottle with 400ml fill volume for a placebo trial, the final moisture content was not homogeneous within the cake, but the PVP placebo moisture content ranged from 1.6% (top) to 2.2% (bottom). With the tray, the cake was homogeneous, predominantly due to the lower filling height and subsequent lower resistance to mass flow transfer during secondary drying.

However, for tray containers, mass transfer limitation can result from the semi-permeable membrane, which has small pores of hydrophobic materials, which in turn may create a slight resistance to mass transfer. Limitations of membrane permeability were observed using our two-day cycle when the trays inflated. However, this was resolved when we adopted a three-day cycle.

Heat transfer through the plastic bottom-film of the tray also contributes to an important difference. Although plastics are known to be less conductive than glass, the plastic membrane thickness is far lower than glass. Our results showed that heat transfer was not a limitation in this case. Other differences included the lower distance to the center of the tray container compared with the bottles and the large contact area between the shelf and a low fill depth, resulting in optimal efficiency of the shelf surface. All of these differences contributed to a cycle time reduction of more than 60% compared with the former cycle and an increase of quantity loaded by batch inside the freeze-dryer - *Table D*.

Another difference between large glass bottles and membrane trays is stoppering, which creates additional stresses within glass vials. Indeed, the tensions accumulated inside the glass may be released when force is applied to the bottom surface, resulting in glass breakage, which can have a huge impact on product yields - *Figure 14*.

## Conclusions

Freeze-drying process transfer from glass bottles to single-use ePTFE membrane trays is feasible and profitable in terms of freeze-drying capacity for this specific project. However, careful process evaluation needs to be undertaken to demonstrate container compatibility and estimate the heat and mass transfer properties for the two containers. Robust process validation is a key element to success and a good understanding of the freeze-drying process is advantageous in speeding up the transfer process and releasing a quality product.

## References

1. MacKenzie, A.P., "The Physico-Chemical Basis for the Freeze-Drying Process," *Developments in Biological Standardization*, October 1976, 36:51-67.
2. Pikal, M.J., Roy, M.L., Shah, S., "Mass and Heat Transfer in Vial Freeze-Drying of Pharmaceuticals: Role of the

- Vial," *Journal of Pharmaceutical Sciences*, 73 (9): 1224-37, 1984.
3. Mayeresse, Y., Veillon, R., "On the Way to Rational Freeze-Drying," *American Pharmaceutical Review*, 2006.
  4. Mayeresse, Y., "Freeze-Drying Process Validation," *Drug Manufacturing and Supply*, 2006.
  5. Chapman, K., "The PAR Approach to Process Validation," *Pharmaceutical Technology*, Vol. 8, No. 12, pp. 22-36, 1984.
  6. Mellor, J.D., Vapour Transfer in Course of Freeze-Drying, **Advances in Freeze-Drying**, Herman Paris, 1966, pp. 75-88.
  7. Brülls, M., Rasmuson, A., "Heat Transfer in Vial Lyophilisation," *International Journal of Pharmaceutics*, 2002; 246:1-16.
  8. Nail, S.L., "The Effect of Chamber Pressure on Heat Transfer in the Freeze-Drying of Parenteral Solutions," *Journal of Parenteral Drug Association*, 1980; 34, (5): 358-68.
  9. Liu, J., Viverette, T., Virgin, M., Anderson, M., Paresh, D., "A Study of the Impact of the Freezing on the Lyophilisation of a Concentrated Formulation with a High Fill Depth," *Pharmaceutical Development and Technology*, 2005; 10:261-272.
  10. Pikal, M.J., Cardon, S., Bhugra, C., Jameel, F., Rambhatla, S., Mascarenhas, W.J., Akay, H.U., "The Nonsteady State Modeling of Freeze Drying: In-Process Product Temperature and Moisture Content Mapping and Pharmaceutical Product Quality Applications," *Pharmaceutical Development and Technology*, 2005; 10(1):17-32.
  11. Sheehan, P., Liapis, A., "Modeling of the Primary and Secondary Drying Stages of the Freeze Drying of Pharmaceutical Products in Vials: Numerical Results Obtained from the Solution of a Dynamic and Spatially Multi-Dimensional Lyophilization Model for Different Operational Policies," *Biotechnology and Bioengineering*, 1998, Dec 20; 60(6):712-28.
  12. Gassler, M., and Rey, L., Development of a New Concept for Bulk Freeze-Drying: LYOGUARD® Freeze-Dry Packaging, **Freeze-Drying/Lyophilization of Pharmaceutical and Biological Products**, Second Edition, 2004, 325-48.

## Acknowledgements

The authors would like to thank Kent Myers, Jedd Taylor (GSK Biologicals), and their team for setting up the process and undertaking the feasibility studies.

## About the Authors



**Yves Mayeresse** is Senior Freeze-Drying Manager for GlaxoSmithKline Biologicals. He has more than 15 years of experience in the pharmaceutical sector and has worked for different companies. He has managed activities, such as parenterals production, set-up of new freeze-drying facilities, design of freeze-drying cycle and development of new

stabilizers for freeze-dried products. In his current role, he is focusing on industrialization for new vaccines, performing process development and transfer of the products toward the

industrial sites of the group. He is a biochemistry engineer and a member of the Parenteral Drug Association (PDA), the Pharmaceutical and Healthcare Sciences Society (PHSS), and the Association for Clean and Sterile Products (A3P) as well as a regular speaker for conferences on freeze-drying. He can be contacted by telephone: +32-2656-8131 or by email: yves.mayeresse@gskbio.com.



**Vinciane De Cupere** has been with GlaxoSmithKline Biologicals for three years as a scientist. She holds a PhD in agronomic science and bioengineering. During her academic course, she developed research activities in the field of biomaterials and semi-conducting liquid crystalline materials. She is currently working on industrialization for new vaccines, performing process development, and transfer of the products toward the industrial sites of the group. She can be contacted by telephone: +32-2656-5635 or by email: vinciane.de-cupere@gskbio.com.



**Romain Veillon** is a freeze-drying scientist at GlaxoSmithKline Biologicals. He has been involved in parenteral freeze-drying for more than 10 years. He has been involved in new freeze-drying units projects, freeze-drying cycle validation, and support to production in Sanofi Pasteur and Eli Lilly. He is currently focused on new vaccine industrialization, performing process development, evaluation, and validation. He also is involved in PAT development applied to freeze-drying, such as DOE, chemometry, NIR, and vision. He is an industrial pharmacist, specializing in microbiology. He can be contacted by telephone: +32-2656-9752 or by email: veillon@gskbio.com.

GlaxoSmithKline, Rue de L'institut 89, Rixensart, 1330, Belgium.



**Joseph F. Brendle** is the Product Manager for Gore™ Lyoguard® Freeze-Drying Products at W.L. Gore & Associates, Inc., where he is responsible for products and applications using Gore™ membranes in pharmaceutical lyophilization applications. Prior to joining Gore in 2005, Brendle spent 18 years developing and managing freeze-drying technologies for both laboratory and production applications in the pharmaceutical industry at FTS Systems, Inc. and at Steris Corporation. While with FTS Systems, he led collaboration with University of Connecticut and Purdue University to develop SMART Freeze-Dryer™ Technology. He has lectured at numerous companies and industry conferences on freeze-drying technology and holds a BSME from Clarkson University. He can be contacted by telephone: +1-410-506-8956 or by email: jrbrendle@wlgore.com

W.L. Gore & Associates, Inc., 401 Airport Rd., Elkton, Maryland 21921, USA. 

This article presents a description of an operational effectiveness project to improve clinical material manufacturing efficiency of a biologics pilot plant. It utilizes lean and Kaizen principles to identify root causes, then brainstorm/evaluate potential solutions.

## Clinical Manufacturing Efficiency

by Beth H. Junker, Kay Hunsberger, Vicky Griffin, Kent Hamaker, Carl Holz, Amy Caparoni, Kelly Kistler, Jeffrey Graczyk, and Marshall Gayton

### Introduction

**D**riving operational excellence improvements into non-manufacturing areas, such as process development and manufacturing clinical supplies, can be a cultural shift for managers as well as bench staff.<sup>3</sup> There is a natural tension between efficiency, control, and process excellence (all of which demand precision, consistency, and repetition) and innovation (which demands variation, failure, and serendipity).<sup>2</sup> However, operational excellence improvements can boost the available time and capacity for execution of new processes through the streamlining of lower priority activities.

Traditional lean practices also are challenging to apply to highly variable and shared asset environments typical of multi-product biopharmaceutical processing facilities,<sup>3</sup> especially those largely devoted to early phase clinical manufacturing. The less routine, repetitive, and predictable the activity, the more difficult to apply lean and six sigma tools.<sup>4</sup> In addition, it is notably harder to apply lean controls to less efficient processes and facilities,<sup>5</sup> which often are associated with early phase clinical manufacturing. Improvement opportunities in such

environments frequently are cross-functional requiring substantial collaboration across the organization.<sup>6</sup>

Operational excellence obstacles to improving clinical manufacturing efficiency overlap with those commonly identified for efficiency initiatives in other industries. These are: 1. identifying adequate metrics to quantify performance, 2. overcoming required cultural changes in the organization, and 3. applying these concepts to non-production aspects of clinical manufacturing environments, such as business processes that largely rely on human actions.<sup>7</sup> Furthermore, organizational silos and less integrated operations often prevent decision-making based on impact on overall workflow and/or key performance indicators.<sup>3,8</sup> Uneven sponsorship by managers and “on the floor” supervisors also hinders achieving and sustaining the necessary leadership and culture for change.<sup>8</sup>

In addition, service families (product groups possessing similar processing steps) in lean applications can be viewed as product platforms in biopharmaceutical processing, specifically groups of products that undergo similar processing steps, such as some vaccines (e.g., plasmid DNA) and therapeutic proteins (e.g., antibodies). Separate platforms cover cell line, upstream, downstream, and formulation aspects of bioprocessing. Despite the need to allocate significant upfront costs and resources to their development, process platforms improve process efficiency, reduce subsequent development and production costs, improve speed to market, and free up substantial resources for other projects.<sup>9,10,11</sup> Platforms standardize a broad range of manufacturing steps and materials (e.g., production equipment, media, buffers, bioreactor

Figure 1. Generalized process flow diagram for clinical manufacturing of a platform CHO antibody bulk. [Raw Material (RM), Culture Media (CM), Atypical Process Reports (APRs)].

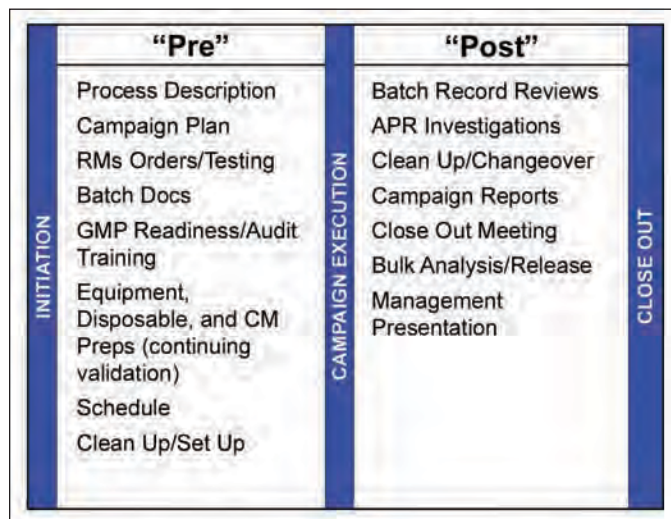

Reprinted from  
**PHARMACEUTICAL  
 ENGINEERING®**  
 The Official Magazine of ISPE  
 March/April 2009,  
 Vol. 29 No. 2  
 ©Copyright ISPE 2009  
 www.ISPE.org

Continued on page 50.

# Innovation makes it possible

Telstar Life Science solutions is constantly innovating to offer tailor-made solutions in high technology equipment for the pharmaceutical, biotech and related industries.

With over 45 years of experience and an international presence in more than 100 countries, Telstar is your partner to provide solutions in the following technologies:



High Containment Isolators



Sterilization Systems, WFI & Pharmaceutical Steam Generation Systems



Freeze Drying Systems



### Containment Systems

- Isolators
- Restricted Access Barrier Systems (RABS)
- Downflow booths

### Sterilization Systems

- Moist heat sterilization autoclaves
- Chemical agent sterilization autoclaves
- Sterilization and depyrogenation ovens

### WFI & Pharmaceutical Steam Generation Systems

- Multiple/simple effects stills
- Pure steam generators

### Freeze Drying Systems

- GMP production freeze dryers
- Laboratory freeze dryers
- Loading & unloading systems

### Laminar Air Flow Systems

- Laminar flow benches
- Biosafety cabinets
- Laminar flow booths
- Customized cabinets

### Drying Systems

- Hot air drying
- Vacuum drying

### TELSTAR LIFE SCIENCES

Josep Tapioles 120  
08226 Terrassa (Spain)  
T. +34 937 361 600  
F. +34 937 859 342  
sales.pharma@telstar.eu

### TELSTAR NORTH AMERICA

1504 Grundy's Lane,  
Bristol, PA 19007 (USA)  
T. +1 215 826 0770  
F. +1 215 826 0222  
telstar.na@telstar.eu



conditions, filters, chromatography resins, batch records, automation systems, quality procedures)<sup>10</sup> permitting facility, equipment, and business process standardization. When the product is amenable, product-specific customization is greatly minimized for platforms, especially for early phase products, compared with non-platform technologies.

## Opportunity and Scope

Clinical manufacturing in a multi-product pilot-scale GMP bioprocessing facility is primarily limited by personnel, and in a few cases, shared equipment, potentially resulting in clinical delays for various product candidates (i.e., therapeutic proteins, vaccines). A typical clinical manufacturing campaign involves several dozen personnel, a series of individual high technology bioprocessing facility suites, as well as significant expenses for raw materials, consumables, and maintenance.

The goal of this project was to identify and reduce waste in campaign “pre” and “post” activities. “Pre” and “post” activities such as campaign planning, batch sheet document generation, training, raw material/culture media release, set up/clean up, and closeout activities were in scope - *Figure 1*. “During” activities associated with campaign execution, as well as analysis and release of manufacturing bulk, were out of scope. Alteration of GMP, safety, or environmental regulations also was considered out of scope.

Specifically, the project goal was to reduce campaign-associated professional staff time by 10% and cycle time by 25%. This effort focused on improving clinical manufacturing efficiency via streamlining of “pre” and “post” activities (i.e., availability) to raise batch throughput with the same personnel level. Future efforts may focus on “during” activities (i.e., performance) and rework/reprocessing (i.e., quality).

## Project Approach

The project approach was first to focus analysis on the most frequent type of product campaign conducted in the facility, Chinese Hamster Ovary (CHO)-derived monoclonal antibody bulks produced using a documented processing platform. These campaigns were used to develop, qualify, and quantify (where possible) the current state. Because these campaigns were the most common, as well as more recently executed, it was more straightforward for team members and other subject matter experts to reach consensus based on their individual past experiences. As each of the remaining project deliverables were developed, their applicability to other campaign types (i.e., other therapeutic proteins or vaccines) was checked. In nearly all cases, the deliverables were found applicable to some extent.

The project utilized a hybrid lean/Kaizen approach over a time period of about four months. Using voice of the customer information, current state estimates and data, and current state value stream mapping (visualization of all activities creating customer value), four Critical-To-Quality (CTQ) key measurable characteristics that satisfy the customer when achieved, areas were established. These CTQs were: 1. documentation, 2. clean up/set up, 3. raw material/culture

media (RM/CMs) release, and 4. training. This effort was followed by creation of a current state swim lane map (showing which group executes what steps when multiple groups are working together). For each CTQ, a root cause analysis was conducted, followed by solution brainstorming, ranking, analysis, and prioritization. Next, a future state swim lane map (showing how the process will operate once improvements are implemented) was developed, linked to enabling improvement solutions, and benefits quantified. Finally, new performance targets and an improvement process control plan were established.

## Critical to Quality Areas

### *Voice of the Customer*

Voice of the Customer (VOC) information was collected using interviews and surveys of personnel at first line and upper management, as well as bench staff levels. Main customers resided in the clinical manufacturing, quality, and process development areas. Clinical manufacturing management was particularly interested in clarifying roles and responsibilities, raising information transfer reliability, improving staff’s understanding of their colleague’s roles, and broadening change opportunity identification and execution. Clinical manufacturing staff members were particularly interested in task standardization along with reducing multi-tasking and multi-campaign responsibilities. Quality was particularly interested in instituting focused campaign closeout timelines. Process development was particularly interested in expanding opportunities for processing flexibility where possible.

Key customer themes were efficient business processes, including reduction of multi-tasking stresses and raising staff’s ownership, accountability, and focus. When customer concerns were organized into related categories, three areas of commonality were revealed: 1. project management (specifically competing task priorities, schedule churn, and sub-optimal communication with stakeholders, partners, and customers), 2. systems (specifically selection, procurement, storage, testing, and release of Raw Materials (RM) and Culture Media (CM); ordering, availability, assembly, sterilization, and delivery of disposable and non-disposable parts; equipment preparation particularly to address pre-campaign audit findings; training attendance and effectiveness; and knowledge management expectations and procedures), and 3. roles and responsibilities (specifically ownership, hand-offs, and timeline adherence).

## Value Stream Mapping

Value stream mapping was undertaken using a highly simplified process flow diagram from campaign initiation through closeout, omitting depiction of overlapping and parallel activities - *Figure 1*. Four activity classifications emerged as high pain and inefficient areas: 1. documentation (i.e., draft and final pre-execution documents as well as post-execution closeout), 2. raw materials and culture media (i.e., ordering, testing, and release), 3. clean up/set up (i.e., assembly, cleaning, verification, and sanitization/sterilization), and 4. training (i.e., scheduling and content). These activity classifications were the identified CTQs for the overall goal of efficient processes

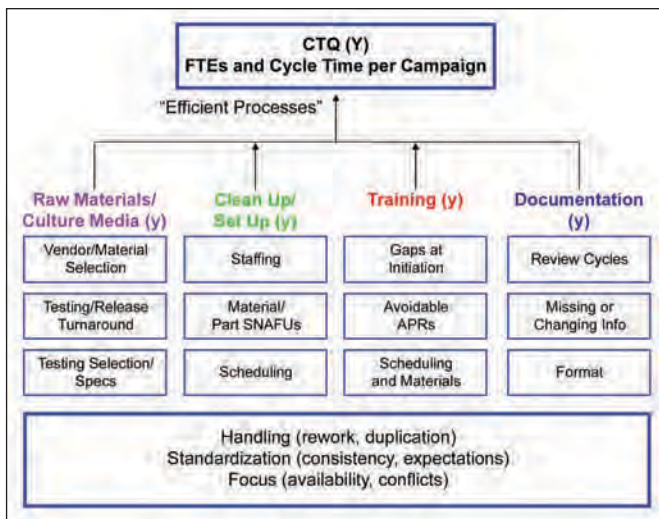

Figure 2. Critical-to-Quality attributes for clinical manufacturing of a platform CHO antibody bulk.

for clinical campaigns - *Figure 2*. Key input factors for each CTQ, later revealed during root cause analysis, were listed below each individual CTQ. Common root causes across CTQs were listed at the bottom.

The longest cycle time activities within the project scope were RM/CM release and documentation - *Figure 3*. As a first step, typical cycle time, touch time, touch time/cycle time ratios, first pass yields, and personnel resources were estimated based on platform CHO antibody campaign experiences - *Figure 3 inset*. Where available, data was used for validation of these estimates. Specifically, “pre” and “post” campaign activities accounted for 62% of the total campaign personnel resources (38% “pre” and 24% “post”); equipment set-up/clean-up activities accounted for 60% of the total downstream isolation cycle time.

## Initial State Swim Lane Map

A swim lane map showing serial and parallel (or overlapping) activities was developed based on the current state of platform CHO antibody campaigns. *Figure 4* shows the “pre” phase

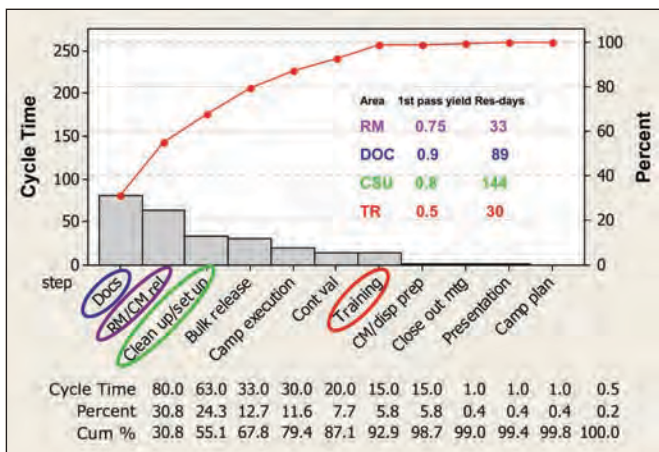

Figure 3. Pareto chart of key process steps for clinical manufacturing of a platform CHO antibody bulk. Inset: First time yield and resources for key critical to quality attributes. [Docs = documentation, RM/CM rel = raw material/culture media ordering, testing and release].

and *Figure 5* shows the “post” phase. The team attempted to convert as many of the serial activities to parallel activities as possible, then determined how to streamline the key serial activities, i.e., the four CTQs from the value stream map: 1. documentation (docs), 2. raw materials and culture medium (RM/CM), 3. clean up/set up, and 4. training. The goal was to identify and remove waste in the form of wasted movement, wasted time, physical/material waste, wasted protocols/procedures, and reduced rework/failures.<sup>12</sup>

Based on entitlement estimates (expected efficiencies based on attaining reasonable improvement levels) and supported where possible by data, six weeks were eliminated, three from “pre” and three from “post” activities - *Figures 4 and 5*. An additional one week likely could be eliminated from both “pre” and “post” activities, but that elimination was considered too aggressive at this time. Key cycle time changes were aligned with the four CTQs - *Tables A and B*: 1. require process description (authored by process development staff) at campaign planning initiation - *Figure 4*, 2. condense pre-campaign training to three weeks - *Figure 4*, 3. reduce equipment and suite GMP readiness and pre-execution documentation draft and review cycles to one week each - *Figure 4*, 4. reduce in-suite set up/clean up (specifically suite changeover) by one week - *Figure 5*, 5. reduce RM/CM testing/release time to five weeks - *Figure 5*, 6. reduce post-execution documentation review time (both batch records and atypicals) to four weeks - *Figure 5*.

## Root Cause Identification

Root cause identification was undertaken to determine how to improve efficiency for the four CTQs that emerged.

First, general root causes were established based on identified trends observed in the VOC collection phase. Lower first pass yields (fraction of work completed correctly on the initial try) of around 0.7 to 0.8 for some activities associated with

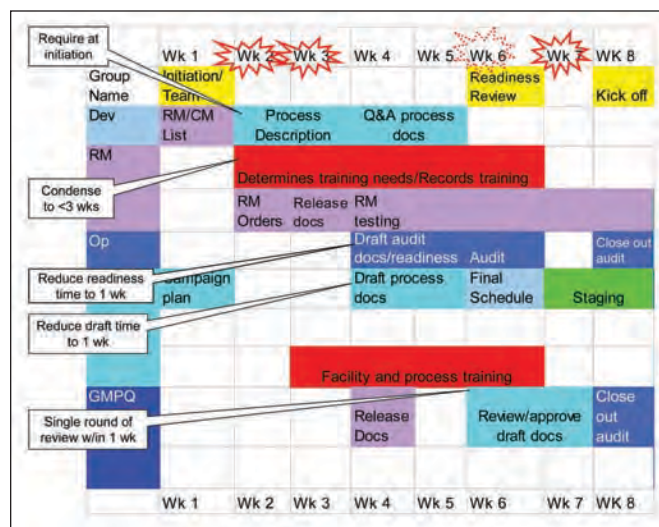

Figure 4. Current state swim lane map for initiation to kick off (“pre”) of clinical manufacturing of a platform CHO antibody bulk. Potential reduction of three weeks (possibly four). [Dev = process development, RM = raw material planners, Op = clinical manufacturing operations, Proc = clinical manufacturing processing, GMPQ = quality].

Continued on page 52.

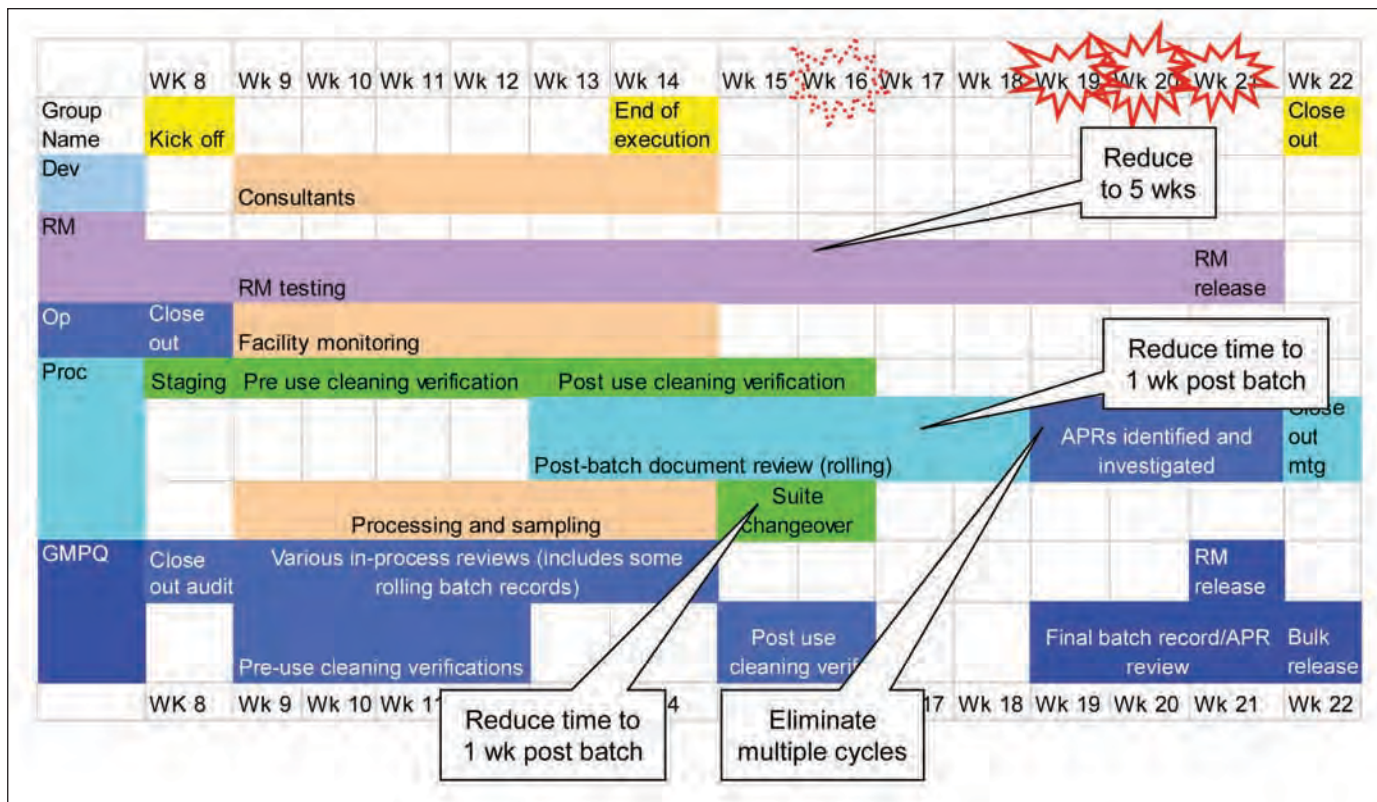

Figure 5. Current state swim lane map for kick off to close out (“execution” and “post”) of clinical manufacturing of a platform CHO antibody bulk. Potential reduction of three weeks (possibly four). [Dev = process development, RM = raw material planners, Op = clinical manufacturing operations, Proc = clinical manufacturing processing, GMPO = quality].

platform campaigns. This low value suggested remaining execution variability despite undertaking a platform process, likely owing to incomplete platform adherence. Ripple effects of small changes or missing information among multiple areas suggested significant data duplication, specifically in documentation. Multiple rounds of rework suggested that 1. the activity timing or level of detail was not aligned with process lock down (or vice-versa) and 2. expectations for con-

tent, format, and timing between stakeholders and customers (e.g., reviewers and approvers) were not clear. These general root causes - Figure 2 translated into issues of handling (i.e., expending additional effort beyond what is required), standardization (i.e., limited effectiveness in sharing best practices among multiple people conducting similar tasks), and focus (i.e., varied task demands and competing priorities causing resource availability conflicts).

CTQ	Root Cause	Cycle time changes	Project Solution
RM/CMs	Vendor selection Material selection Allocation Test selection Specification setting	RM/CM list at planning initiation	Preferred vendor list for proc dev and orders Approved RM list for proc dev and orders Locked-unlocked info in RM/CM list Future IT solution Next belt project Next belt project
Docs	Process changes Standardization Info/task duplication	Process description at planning initiation Reduce draft and review cycles to one week each	Locked-unlocked info in process description Expectation checklist Table/bullet format Streamline type/number of items tracked Annual equip audits, equipment owner, safety leverage/gap analysis for audits/readiness
Clean up/ set up	Staffing level Cycle overkill Parts in suite	Reduce audit/readiness to 1 week	Reduce from 2 to 1 except where required Create buffer cycle to lower buffer prep time Establish bins for COPs for common skids Establish out-of-suite storage area/standard staging
Training	Availability/conflicts Proximity	Condense to 3 weeks Virtual/video training	Attendance expectations/shared calendar

Table A. Relation of CTQs to root causes to cycle time changes and enabling project solutions for initiation to kick off (“pre”) of clinical manufacturing of a platform CHO antibody bulk.

Specific root causes for each of the four CTQs then were brainstormed using a fishbone diagram with branches for material (e.g., raw material quality, part availability, utility reliability), methods/manufacture (e.g., abnormal operation, unclear/inconsistent procedures, suboptimal process set points or other specifications, changing guidelines/regulations), manpower (e.g., manual steps and control, technical expertise, knowledge transfer), machine (e.g., inefficient equipment, frequent equipment breakdown, insufficient capacity), measurement (e.g., instrument failure or error, miscalculation, lack of measurement), and environment (e.g., seasonal/holiday patterns, management structure, physical locations).<sup>13</sup> These specific root causes are listed in Table A for “pre” and Table B for “post” activities.

### Solution Identification

#### *Solution Matrix*

During multiple team sessions focusing on closing individual CTQs gaps, potential solutions were brainstormed and evaluated based on effort/impact (2x2 matrix) and customer importance criteria (Pugh matrix). About 100 solutions were designated high impact (~50 low and 50 high effort), and about 20 solutions were low impact (~10 low and ~10 high effort). All low effort/high impact and selected high effort/high impact solutions from the 2X2 matrix were then evaluated using the Pugh matrix. Customer importance criteria were roughly equally weighted by team members, then used to evaluate a solution's impact (rated as +1 if beneficial, 0 if neutral, or -1 if harmful) on resources per campaign, cycle time, first pass yield, campaign lead time, staff multi-tasking/availability, communication/hand-offs/ownership, knowledge management, and effective use of talent. The highest net benefit scores were used to select key solutions. Based on VOC information, process inputs with the largest impact on these customer importance criteria were deliverables from the process development staff, business process consistency, and level of risk tolerance; solutions that were related to these particular

process inputs thus, were considered more desirable.

High impact proposed solutions, particularly those that also were low effort, were vetted more closely for benefits, resources to implement, realization risks, risk mitigation, performance metrics, and control plans. A formal Failure Modes and Effects Analysis (FMEA), i.e., systemic determination of seriousness and sources of potential process problems) rating

was not conducted owing to the number of proposed solutions; qualitative assessments of realization risks were considered adequate to support further solution selection. Solutions with the clearest impact to the CTQs of this efficiency project (Tables A and B) were prioritized with additional ones to be added as initial ones were completed. Priority low effort/high impact solutions (i.e., implementable within one to three months) were assigned to clinical

*Continued on page 54.*

## Valve Communication for Today's Control Systems

- Innovative Sensing Technology for Reliability and Repeatability
- Remote Programming for Efficiency in Commissioning and Operations
- Status and Diagnostics Remote and Local Display



CALL US TODAY AT 404-344-8970.

**GEMÜ**® VALVES, ACTUATORS AND CONTROL SYSTEMS

3800 CAMP CREEK PARKWAY • BLDG. 2600 • SUITE 120  
ATLANTA, GA 30331 • FAX 404-344-9350 • [www.gemu.com](http://www.gemu.com)

CTQ	Root Cause	Cycle time changes	Project Solution
RM/CMs	Testing/release turnaround Insufficient tech support <i>At risk usage</i>	Reduce testing/release to 5 weeks	Establish test time expectations/data entry Designated analytical RM/CM analyst expert <i>Next belt project</i>
Docs	Suitability Availability/conflicts	Reduce closeout to 4 weeks	Expectation checklist, APR mapping workgroup Consolidated document closeout effort Designated campaign closer
Clean/ set up	Availability/conflicts	Reduce by 1 week	Consolidated clean up effort Reduce CIP staffing from 2 to 1 except when required

Table B. Relation of CTQs to root causes to cycle time changes and enabling project solutions for execution to closeout (“post”) of clinical manufacturing of a platform CHO antibody bulk.

manufacturing staff (working jointly with stakeholders) and an identified project team champion/liasons. Priority high effort/high impact solutions (i.e., requiring more than one to three months) were also identified and tracked to provide a complete solution portfolio to the clinical manufacturing leadership team.

## Future State Swim Lane Map

Future state swim lane maps were constructed for the “pre” and “post” phases of platform CHO antibody campaigns - *Figures 6 and 7*. Identified enabling solutions (Tables A and B) were used to translate future state entitlement maps into concrete action plans and measurable goals. Long cycle times remained for bulk release and campaign execution (both out of scope for this initial project). This future state eliminated six weeks to generate a new process lead time (PLT) of ~16 weeks (3.7 months).

One example of an enabling solution was to require a raw materials list and locked process description at campaign planning initiation ~six weeks before processing kick off in the future state - *Figure 6*. This trigger cut down two weeks of lead time previously devoted to process description changes and updates. To enable this change (and achieve other busi-

ness goals), process development activities were frontloaded (i.e., undertaken earlier in the product development timeline). Also, process description requirements were redesigned to lock certain inputs with substantial “pre” phase impact (e.g., equipment size, resin type) and permit flexibility up to pre-execution batch sheet approval for other inputs with negligible “pre” phase impact (e.g., buffer pH).

In addition to process description changes, other areas to standardize to raise first pass yields included creating and circulating checklists detailing batch sheet documentation expectation requirements (both “pre” and “post” approval - *Figures 6 and 7* respectively), uniformly calculating preparation/processing times and listing execution issues in campaign reports (e.g., campaign step summaries - *Figure 7*), and streamlining the type/number of equipment items tracked for campaign readiness checks - *Figure 6*. Documentation (e.g., batch sheets, audits, process descriptions) was best cast in a reusable table or bullet format so that translation or reference to other documents (e.g., Atypical Processing Reports (APRs), step summaries) was facilitated - *Figure 6*. Information duplication was reduced by leveraging work already completed (e.g., referencing not attaching original documentation), and for similar processes, performing a gap analysis focused only on changes from a designated base process - *Figure 6*.

Other key enabling solutions applying to the “pre” campaign phase (*Figure 6*) were to 1. decrease buffer preparation lead time by establishing a reduced cleaning cycle appropriate for buffers (substantially shorter than the worst case fermentation media cleaning cycle), 2. minimize training at the time of the specific campaign, 3. develop a shared electronic training calendar to avoid training session schedule conflicts, 4. prepare virtual/video training available on demand for key training sessions, 5. establish bins for clean-out-of-place (COP) parts associated with commonly used skids (parts remained together from use to cleaning to assembly and back again), 6. right-size CIP staffing by assigning two people only when required by GMP or safety/environmental regulations rather than routinely, and 7. minimize raw material release timelines by instituting easy-to-read approved raw material and preferred vendor lists for process development staff to reference when process changes were required.

Additional key enabling solutions applying to the “post” campaign phase (*Figure 7*) were to 1. establish a target of one week post campaign for closeout activities by maintaining associated personnel undistracted on the current campaign,

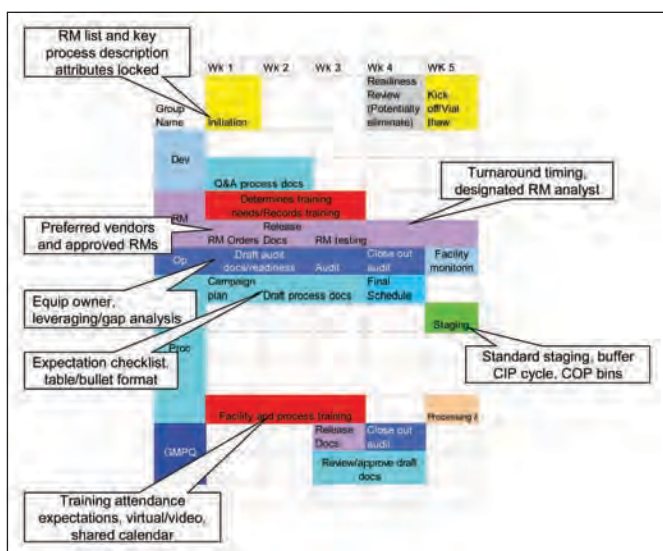

Figure 6. Future state swim lane map showing five week cycle time from initiation to kick off (“pre”) of clinical manufacturing of a platform CHO antibody bulk. [Dev = process development, RM = raw material planners, Op = clinical manufacturing operations, Proc = clinical manufacturing processing, GMPQ = quality].

2. implement daily (rolling) in-process batch sheet reviews according to an expectation checklist, 3. streamline APR resolution using joint operations/quality meetings to outline investigation strategy and subsequent write up before initiating investigations, 4. decrease turnaround time for Raw Material and Culture Media/Buffer (RM/CM) release by establishing target testing turnaround times with contract laboratories as well as setting up contract lab personnel to remotely enter results directly into the area's LIMS system, and 5. improve knowledge management via follow up on lessons learned and high quality team leader training meetings.

Key personnel roles to establish for realizing the future state were: 1. a campaign closer to coordinate post-execution document reviews and approvals (also eventually including in process reviews) as well as suite clean-up and changeover, 2. a designated analyst for technical support to streamline raw material and culture media release, including Out-Of-Specification (OOS) investigations (Figure 7), and 3. equipment and suite owners to facilitate equipment and suite readiness for GMP operation, for example, by performing annual equipment audits and then rigorously controlling equipment usage and modifications - Figure 6.

In envisioning the future state, each clinical manufacturing campaign team is akin to a production cell in that the goal is to arrange equipment (and/or dedicate personnel) for a smooth process flow such that progressive processing occurs

without waiting or additional handling. The documentation (both GMP and non-GMP) associated with campaign planning, execution, and wrap-up is essentially standardized work, for which a precise description can be devised specifying its cycle time (actual process output rate), takt time (desired process output rate to meet demand), work sequence, and minimum required "parts" inventory in the form of advance preparation time.<sup>14</sup> Standardized work elements (specifying the best method to execute the job correctly the first time) already exist for actual biopharmaceutical process execution in the form of SOPs, testing methods, and validation protocols; however, these documents often omit key details resulting in variations in how steps are completed to achieve the same result.<sup>15</sup> The same gap holds true for standardized work elements applicable to "pre" and "post" campaign activities. Clear documented roles and responsibilities at the appropriate level also were required.

### Future State Benefits and Performance Targets

Cumulative manpower and cycle time benefits for "pre" and "post" activities were calculated for selected low effort/high impact solutions for a platform CHO antibody campaign. The manpower benefit identified was 16.5%, exceeding the target of 10%, with one change (right sizing CIP staffing) accounting for 8.5% of the reduction. The cycle time benefit was 37.5%,

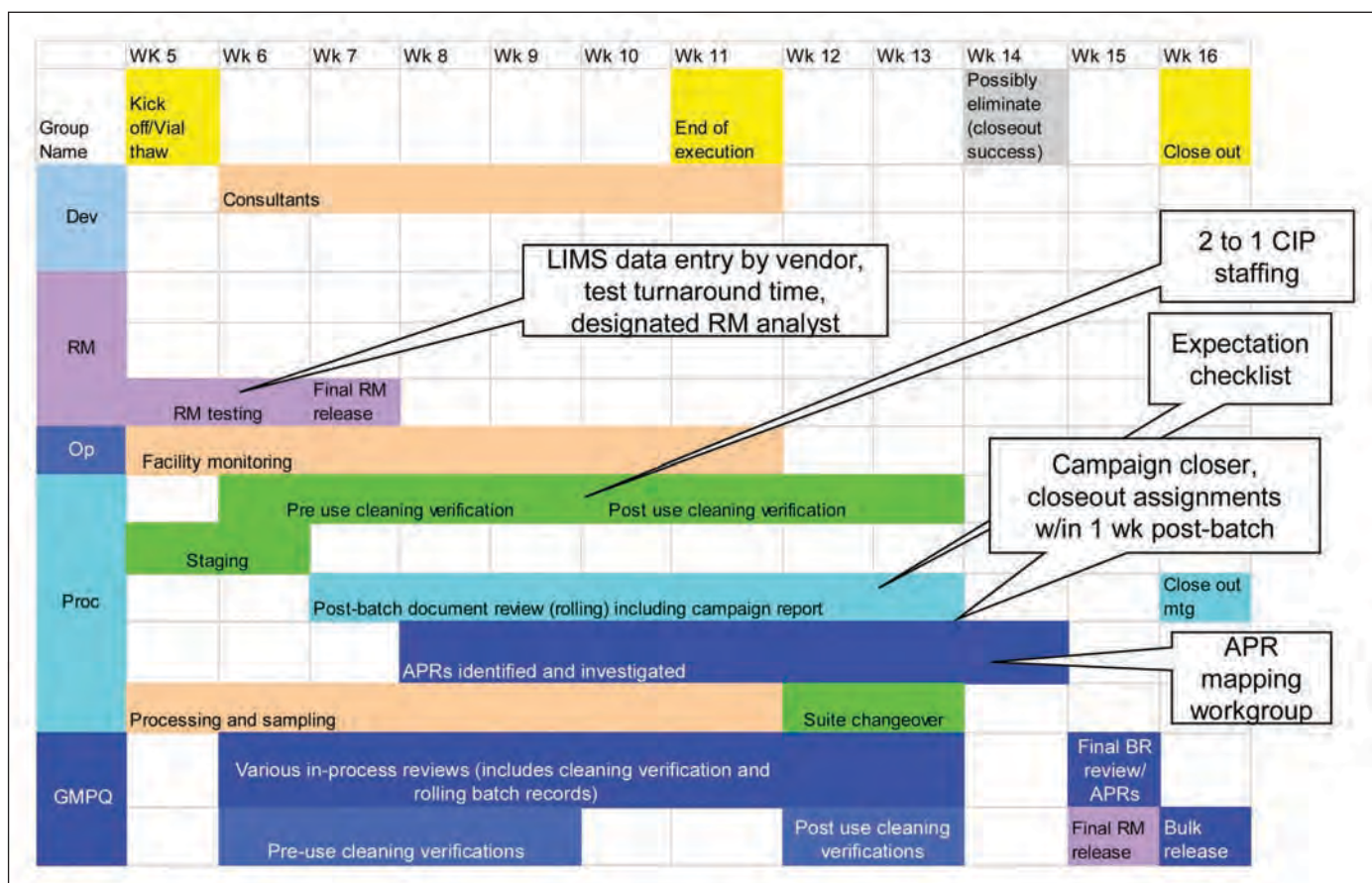

Figure 7. Future state swim lane map showing 12 week cycle time from kick off to close out ("execution" and "post") of clinical manufacturing of a platform CHO antibody bulk (total cycle time from initiation to close out of sixteen weeks). [Dev = process development, RM = raw material planners, Op = clinical manufacturing operations, Proc = clinical manufacturing processing, GMPQ = quality].

Continued on page 56.

exceeding the target of 25%.

Specific future state performance targets also were calculated based on a platform CHO antibody campaign. These targets were to 1. reduce manpower by 10%, 2. reduce the “pre” and “post” campaign manpower proportion by 30%, 3. reduce the Process Lead Time (PLT), i.e., time from initiation to close out for one campaign, to 3.7 months, 4. decrease Work-In-Progress (WIP), i.e., number of bulk campaigns being concurrently either planned, executed, or closed out, to three, and 5. reducing in suite set up/cleanup time to three weeks thus increasing suite overall availability to 57%. In addition to these targets, the number of atypicals (APRs), Out-of-Specifications (OOSs), and other deviations was desired to remain constant (or even decrease), particularly those due to human error to ensure that the implemented solutions did not raise numbers of avoidable mistakes.

## Implementation and Control

The solution portfolio was assembled and vetted. Where applicable, initiatives in progress outside of this project were included to generate a comprehensive list for the area’s senior leadership team to evaluate for prioritization against limited manpower availability for initiatives. Lower and higher effort high impact priorities were established. Since not all solutions were able to be adopted simultaneously, as some solutions were completed other solutions were to be initiated. Thus, considering available staff time, selected solutions were given the go-ahead and assignments made. An implementation tracking spreadsheet was created to track progress. The project team collected and reviewed updates weekly and then met monthly with the area’s leadership team to review progress. In a few cases, pilot implementations were conducted, particularly applying solutions first to more frequently executed campaign steps (e.g., filtration).

A reasonable yet robust control plan also was developed. Existing metrics were leveraged and new metrics established where needed. A dashboard was created and graphs loaded with prior campaign data over the last two to three years. Targets were set for platform CHO antibody campaigns (based on the more extensive prior experience in the facility), but performance of other product campaigns types also was tracked for comparability.

The initial metrics selected were: 1. personnel effort/campaign (a measure of staffing and execution efficiency), 2. campaign initiation to closeout time (a measure of focused effort to maintain campaign throughput), 3. number of bulk campaigns simultaneously in any stage from initiation to closeout (a measure of limiting work in progress to retain focus), 4. length of longest release time for a campaign’s raw material since any unreleased item delayed close out (a measure of both utilization of approved raw materials or preferred vendors and testing lab turnaround time/release efficiency), 5. percentage of buffers in a campaign able to undergo established reduced testing regimens (a measure of preferential utilization of preferred buffers), 6. percentage training matrix completion at initiation (a measure of personnel retention on multiple campaigns and ability to schedule training off

critical campaign paths), 7. non-equipment-related SNAFUs during clean up/set up (a measure of part availability and preparation suitability), 8. length of longest atypical report completion time (a measure of utility of available guidance documents and pre-investigation meetings), 9. right first time and hours required for document audit for quality approval (a measure of checklist effectiveness at outlining expectations), and 10. percentage of avoidable atypicals (a measure of training effectiveness since training gaps were usually cited when human error was identified as the root cause).

As high effort/high impact solutions became implemented, additional metrics were to be added. These included 1. the percentage of time for set up/clean up relative to process time (a measure of cleaning procedure efficiency), 2. a qualitative assessment of pre-campaign GMP, safety, and environmental checklist execution effort expended (a measure of leveraged work from prior campaigns), and 3. the percentage of approved raw materials/preferred vendors utilized per campaign (a measure of adherence to and suitability of the listing).

The project then was officially turned over to a single process owner (an experienced staff member in the clinical manufacturing area) for clear accountability, specifically for continuing the implementation and updating the dashboard monthly with new data from recently completed campaigns. Future platform CHO antibody campaigns were expected to be intermittent (<25% of all area campaigns) owing to changing product pipelines. Success of key improvements appeared measurable based on the performance of other product campaign types. However, measured improvements may be smaller owing to other sources of associated inefficiency for non-platform work.

Five potential larger impact derailleurs to overall implementation were mitigated by control measures or other means. Specifically: 1. exceptions to the process description and approved raw material/preferred vendor regimens were permitted only with associate director/director approvals; 2. diversions to support unexpected problems and tight timelines were minimized by maintaining strong sponsorship at the senior director/executive director levels; 3. introduction of major new equipment or process changes that extended “pre” campaign efforts was governed by oversight committees which regularly reviewed process development efforts; 4. remaining obstacles to prompt raw material/culture media release (such as at risk usage, test selection, and specification setting) were addressed through a subsequent efficiency effort; and finally, 5. perceptions about the limited time and resources available to work on/implement efficiency initiatives were defused by widely communicating early victories to demonstrate incremental progress toward continuous improvement.

## Summary

The clinical manufacturing efficiency project established a shorter, more efficient, and focused campaign effort from initiation through close out. Utilizing lean/Kaizen techniques, this project not only generated a prioritized and vetted solution portfolio. It also indicated the area of raw materials and culture media to be where application of statistical and other six

sigma tools was likely to be beneficial in a future belt project. When biopharmaceutical pipelines gather momentum, clinical manufacturing throughput often becomes the bottleneck. Expanding resources by adding personnel or equipment can be challenging, especially when simultaneously faced with expense and capital cost-sparing objectives. Consequently, projects aimed at continuous improvement of clinical manufacturing efficiency are valuable solid foundations to support projected biopharmaceutical product development.

### References

1. Puich, M., "Biopharmaceutical Operations Excellence—2006 and Beyond," *Biopharm International*, 19(3):30-32, 2006.
2. Hindo, B., "At 3M, A Struggle between Efficiency and Creativity," *Business Week*, 4038:8-14, 2007, [http://www.businessweek.com/print/magazine/content/07\\_24/b4038406.htm?chan=gil](http://www.businessweek.com/print/magazine/content/07_24/b4038406.htm?chan=gil)
3. Geller, S., "Reduce Waste by Getting Lean," *Pharmaceutical Technology*, 130, March 2007.
4. Wootto, M., "Mining for Value, but Where?" *Pharmaceutical Processing*, 23(9):50-57, 2007.
5. Kanarak, A., "It's About Time! Operational Excellence and the Biopharmaceutical Industry," *BioProcess Int.*, 5 (S6): 20-21, 2007.
6. Puich, M., "Biopharmaceutical Operations Roadmap 2007," *Biopharm International*, 20(4):42-47, 2007.
7. Gras, J.M., Philippe, M., "Application of the Six Sigma Concept in Clinical Laboratories: A Review," *Clin Chem Lab Med.*, 45(6):789-796, 2007.
8. Billesbach, T.J., "Applying Lean Production Principles to a Process Facility," *Production and Inventory Management Journal*, 35(3):40-44, 1994.
9. Anon, "Establishing a Lean R&D Organization," *Issue Brief: Research and Technology Executive Council*, Corp Exec Board, September 2006.
10. Kamarck, M., "In the Quest to Manage Capacity, Biology Trumps Stainless Steel," *BioPharm International*, 20:78, 2007.
11. Kamarck, M.E., Hann, L.E., Adamson, S.R., "Biotech Manufacturing Grows Up," *BioPharm International*, 20(10): 159-164, 2007.
12. Bianco, B., Kowalski, G., "Extending "Lean" to Supply Chains," *Automotive Industries*, 185(6): 72-74, 2005.
13. Han, S.H., Chae, M.J., Im, K.S., Ryu, H.D., "Six Sigma-Based Approach to Improve Performance in Construction Operations," *Journal Management Engineering*, 24:21-31, 2008.
14. Yenker, B., "Glossary of "Lean" Manufacturing," *Control Engineering*, 54(5):21, 2007.
15. Greene, A., O'Rourke, D., "Lean Manufacturing Practice in a cGMP Environment," *Pharmaceutical Technology Europe*, 18(10):33-39, 2006.

Concludes on page 58.



## Pharmaceutical Online Is The Online Industry Standard



### Visit The NEW Pharmaceutical Online

An improved Pharmaceutical Online is now live, putting the latest technical, operational, and regulatory information about the global pharmaceutical development and production industry at your fingertips. A host of new features makes it easier than ever before to find exactly what you need, whether it's product overviews, industry news, technical articles, or anything else related to the field. Visit us at [www.pharmaceuticalonline.com](http://www.pharmaceuticalonline.com).

### Join the community and benefit from...

#### Rich Content

- Latest news and groundbreaking research
- Technical articles, case studies, and white papers
- Product, service, and solution information
- Video demonstrations, datasheets, and other free downloads

#### Site Resources

- Locating and sourcing products and services
- Keeping up with industry trends
- Interacting and collaborating with your peers

#### Free Newsletter

- Delivered every Tuesday and Thursday straight to your Inbox

Join the community today at [www.pharmaceuticalonline.com/signup](http://www.pharmaceuticalonline.com/signup)



## About the Authors



**Beth Junker** is a Senior Scientific Director in the Bioprocess R&D Department at Merck & Co., Inc. She is responsible for operational excellence, as well as safety and environmental compliance. She currently is completing her black belt certification. Previously, she was responsible for two non-GMP laboratory and pilot scale bioprocess operation areas, as well as rapid production of reagent proteins. She received her PhD in biochemical engineering from the Massachusetts Institute of Technology and her BSE in chemical engineering from Princeton University. She can be contacted by telephone: +1-732-594-7010 or email: [beth\\_junker@merck.com](mailto:beth_junker@merck.com).

Merck & Co., Bioprocess Research and Development, Merck Research Laboratories, P.O. Box 2000, RY810-127, Rahway, New Jersey 07090, USA.

**Kay Hunsberger** is an Associate Director in the Bioprocess Clinical Manufacturing and Technology Department at Merck & Co., Inc. She is responsible for the infrastructure to the Biologics Pilot Plant. Previously, she was responsible for the release of both pharmaceutical and biological clinical products to clinical trials. She received her BS in biology/marine science and a BA in biochemistry from East Stroudsburg University. She can be contacted by telephone: +1-215-652-1873 or email: [kay\\_hunsberger@merck.com](mailto:kay_hunsberger@merck.com).

**Vicky Griffin** is a Manager in the Bioprocess Clinical Manufacturing and Technology Department at Merck & Co., Inc. She is responsible for raw material planning and release, and GMP document management. She received her BS in biology/vertebrate physiology from Pennsylvania State University and an MS in quality assurance and regulatory affairs from Temple University. She can be contacted by telephone: +1-215-652-8883 or email: [vicky\\_griffin@merck.com](mailto:vicky_griffin@merck.com).

**Kent Hamaker** is an Associate Director in the Bioprocess Clinical Manufacturing and Technology Department at Merck & Co., Inc. Within the Merck Biologics Pilot Plant, he is responsible for production of biological supplies for use in clinical studies. Previously, he was responsible for operational and engineering support for the manufacture of licensed vaccines and biologics at Merck. He received his PhD and MS in biological engineering from Purdue University, and a BS in biological engineering and BS in biochemistry at Texas A&M University. He can be contacted by telephone: +1-215-652-0197 or email: [kent\\_hamaker@merck.com](mailto:kent_hamaker@merck.com).

**Carl Holz** is a Manager in the Bioprocess Clinical Manufacturing and Technology Department at Merck & Co., Inc. He is responsible for business-side implementation of the Clinical Manufacturing Execution System (CMES), as well as other initiatives related to safety and facility infrastructure within the Biologics Pilot Plant at West Point. Previously, he developed business systems in support of GMP qualifica-

tion efforts. He received his BA in chemistry from Western Maryland College and an MBA from National University. He can be contacted by telephone: +1-215-652-0170 or email: [carl\\_holz@merck.com](mailto:carl_holz@merck.com).

**Amy Caparoni** is a Research Biochemical Engineer in the Bioprocess Clinical Manufacturing and Technology Department at Merck & Co., Inc. She is responsible for vaccine and biologics clinical manufacturing planning and execution. She received her MS in biochemical engineering and BS in chemical engineering from Drexel University. She can be contacted by telephone: +1-215-652-2335 or email: [amy\\_caparoni@merck.com](mailto:amy_caparoni@merck.com).

**Kelly Kistler** is an Application Services Analyst in the MRL Information Technology Preclinical and Licensing Information Services Department at Merck & Co., Inc. As a Business Analyst, he is responsible for IT system requirements and testing. Previously, he was responsible for the implementation of various information systems in bioprocess, including LIMS and quality management systems. He received his MS in information science from Penn State University and his BS in biology from Moravian College. He can be contacted by telephone: +1-215-652-1474 or email: [kelly\\_kistler@merck.com](mailto:kelly_kistler@merck.com).

**Jeffrey Graczyk** is a Research Biologist in the Bioprocess Clinical Manufacturing and Technology Department at Merck & Co., Inc. He is responsible for managing staff in the Culture Media and Sterile Supply Organization in the Biologics Pilot Plant, as well as developing and implementing efficiency projects for the department. Previously, he was a supervisor in the Glasswash and Sterile Supply Department within MMD. He received his BS in biology from Millersville University. He also is currently pursuing an MS in manufacturing systems engineering at Lehigh University. He can be contacted by telephone: +1-215-652-7322 or email: [jeffrey\\_graczyk@merck.com](mailto:jeffrey_graczyk@merck.com).

**Marshall Gayton** is Senior Director of the Bioprocess Clinical Manufacturing and Technology Department at Merck, Inc. He is responsible for operations of a multi-product biologics pilot plant and the preparation of bulk clinical supplies for vaccines and therapeutic proteins. Gayton's experience in API and biopharmaceuticals spans more than 20 years, including manufacturing technical support, purification process development, and technology transfer to manufacturing for natural products and vaccines. He received his BS in chemical engineering from Rutgers University and a MS in chemical engineering from Rice University. He can be contacted by telephone: +1-215-652-1337 or email: [marshall\\_gayton@merck.com](mailto:marshall_gayton@merck.com).

Merck & Co., Bioprocess Research and Development, Merck Research Laboratories, P.O. Box 4, West Point, Pennsylvania 19486, USA. 

This article presents the implementation of a risk-based approach into a supplier's Software Development Workflow and Product's Release Management according to GAMP® 5.

## Using GAMP 5 for Rapid Deployment

by Markus Roemer and Hermann Schaefer

### Introduction

The current IT solution landscape of a typical organization is comprised of many system components, and may include Enterprise Resource Planning (ERP), Manufacturing Execution Systems (MES), Laboratory Information Systems (LIMS), as well as various automation solutions including: Distributed Control System (DCS), Programmable Logic Controller (PLC), Supervisory Control and Data Acquisition (SCADA), and Human Machine Interface (HMI), etc. Traditionally, the search for the best solution has primarily been driven by the functional match of possible solutions against the organization's requirements. The result in most cases is a diverse, multi faceted solution landscape, where components are provided by different software vendors based on their individual technologies, also referred to as "best-of-breed." These various systems also may be connected using a variety of interfaces. This situation poses several challenges for the healthcare industry, including significant costs for providing the appropriate IT infrastructure, development of interfaces to synchronize the various solutions, which in most cases becomes a focus of compliance activities, and last but not least, the maintenance and support costs.

IT solutions are utilized for many reasons, and among them the automation of the business process is a significant driver, with the aim of

increased efficiency of operations, driving down the costs, and improving data flow through the enterprise making data available wherever needed.

If automation of the business process is a key driver, why reduce the resulting benefits by applying a diverse IT landscape which increases cost of IT operation and increases risk of compliance based on complex interfaces? The answer may be that traditionally the systems were focused on particular functionality and thus could not always meet a broader set of business requirements, hence the need to purchase disparate systems to meet all requirements. However, that situation is changing and more healthcare companies are defining their IT landscape based on the "best-in-class" model, where solutions are selected that may not always provide the best functionality for a particular process ("best-of-breed"), but that are superior over a broad range of functional aspects, including homogeneous infrastructure aspects and technological innovation.

### Market Trends and Customer Needs

From a user's perspective, the ideal world would be to have one solution to meet all of their requirements and ideally one technology platform to host the entire solution.

Over the years, both ERP and automation

Figure 1. Release management.

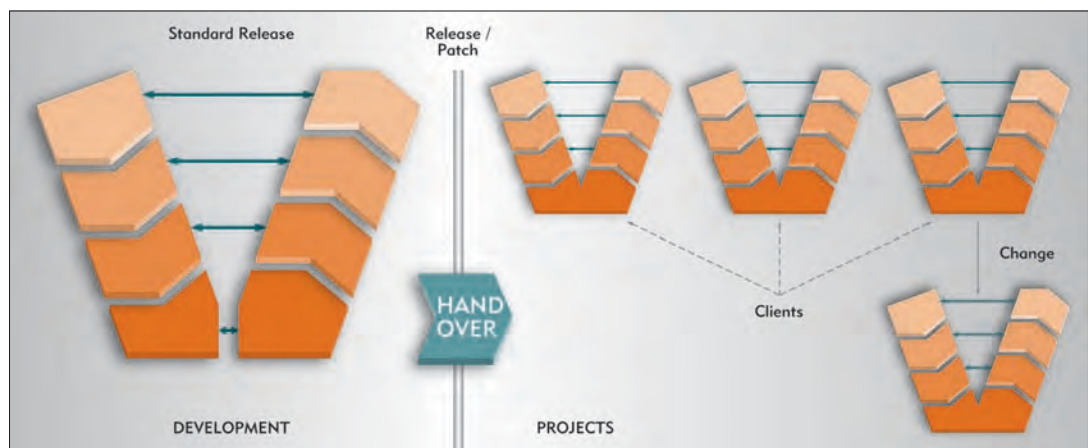

Continued on page 62.

Reprinted from  
**PHARMACEUTICAL  
 ENGINEERING®**  
 The Official Magazine of ISPE  
 March/April 2009,  
 Vol. 29 No. 2  
 ©Copyright ISPE 2009  
 www.ISPE.org



# GEA Niro Soavi Laboratory Homogenizer *type PANDA™* **2K 1001L**

The PANDA™ NS1001 2K is a bench top unit capable of handling a broad range of applications including cell rupture, particle size reduction and emulsions. The PANDA™ 2K with its small hold-up volume and flow rate is ideal for processing small batches of product with results that are directly scalable through to pilot and production machines operating at up to 5500 l/h.

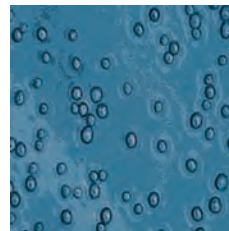

Before

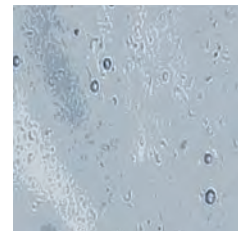

After

PANDA™ NS1001 2K Specifications and Performance:

- Operating pressure 0 – 1500 bar
- Flow rate up to 12 l/h @ 1500 bar
- Minimum sample volume 200ml
- Maximum product viscosity 2000 cPs (20,000 with optional pressure feed)
- Maximum inlet particle size = 0.5mm
- Optional 2nd stage homogenizing valve
- Suitable for CIP and SIP
- ½" Tri Clamp inlet/outlet connections
- Dimensions – L800mm x W460mm x H420mm
- Weight – 85 kg
- 1.8 kW 3ph/60Hz/ 208, 230 or 460V motor (only utility requirement)
- Optional inverter available to allow 1ph/ 60Hz/200-240V power supply

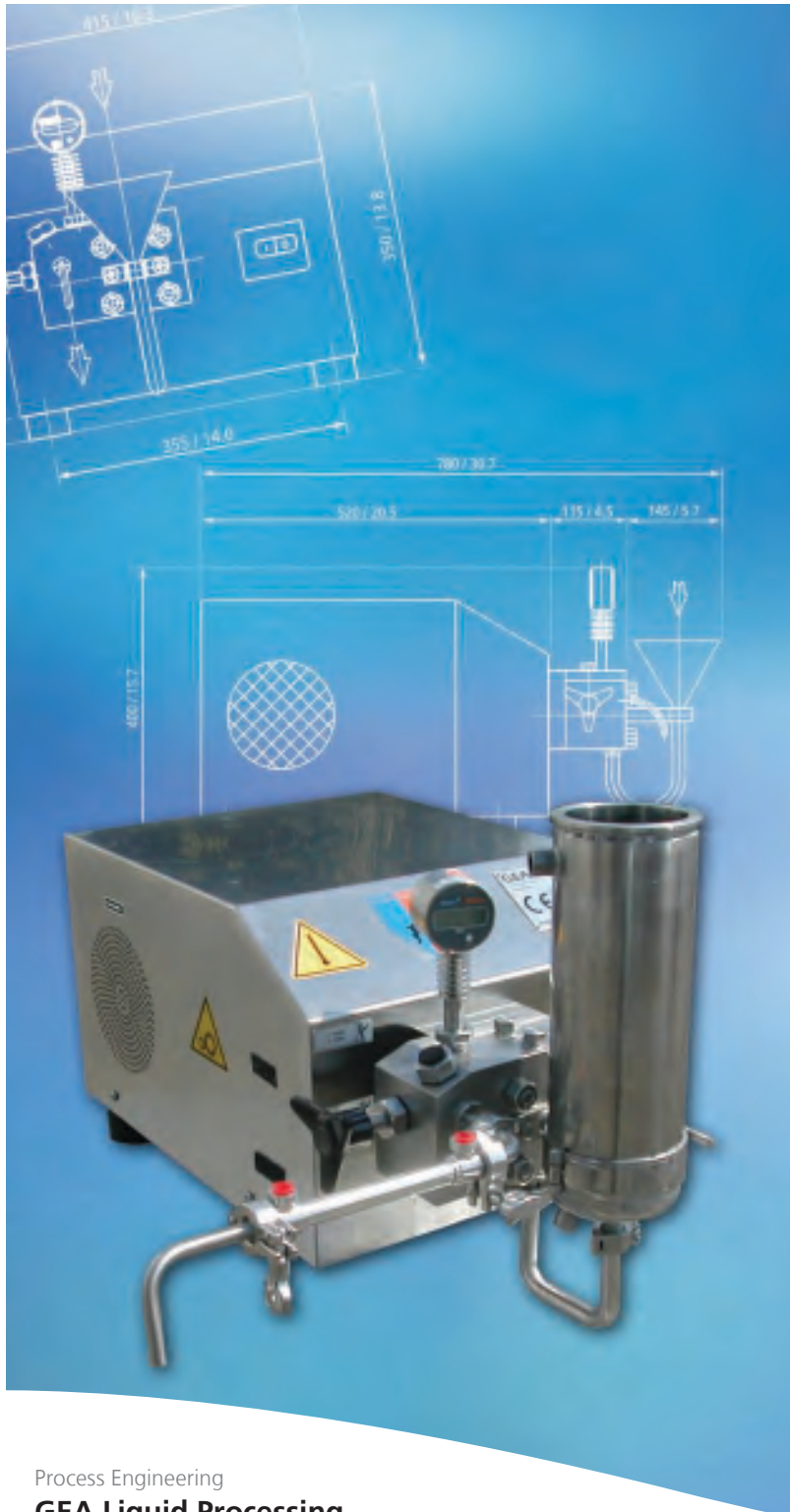

Process Engineering

## GEA Liquid Processing

GEA Process Engineering Inc. • 9165 Rumsey Road • Columbia MD 21045  
Tel: 410 997 8700 • Fax: 410 997 5021  
E-mail: [info@niroinc.com](mailto:info@niroinc.com) • Website: [www.niroinc.com](http://www.niroinc.com)

**Engineering Excellence.**

control vendors have been trying to increase their footprint and provide functionality extending into other areas such as LIMS and Electronic Batch Records. While a clear leader has not yet emerged, there are dominant software product providers who have captured almost all of the enterprise business.

With that in mind, how could further software be developed that could both take advantage of an established IT infrastructure and also could be rapidly deployed?

Let us consider one of the first operational steps in pharmaceutical manufacturing: “Weighing and Dispensing.” There are many systems on the market, but they are typically standalone solutions using their own databases. The automation aspects are not normally challenging since integration is likely limited to scales and possibly bar code equipment. However, integration also is required with the ERP system holding the master product definition, Bill of Materials (BOM), and recipes.

The remainder of this article describes an approach taken to develop weigh and dispense management software based on the key concepts and principles described in GAMP® 5, which can be rapidly deployed by healthcare organizations while taking advantage of existing IT infrastructure. The solution is based on the Systems, Applications, and Products (SAP) Manufacturing Integration and Intelligence (MII) module, which is a tool that can be used to populate all of the SAP transactions, and at the same time, enable business logic and rules to be created. While MII is a tool box and does not provide a packaged solution, it is an appropriate basis for a weighing and dispense solution to meet the following objectives:

- completely based on the ERP
- no other IT infrastructure required for application and database servers
- reuse of the recipe information and order management
- online communication and feedback to the ERP
- one master for batch information and inventory control
- online interface to the scales
- ERP as the one place to hold complete batch information (batch record)

## Pre-Configured, Specified, and Verified

Once the development framework had been selected, a challenge was to work out how the software could be developed such that it could be deployed quickly and cost effectively in a regulated and compliant healthcare environment. The issue was to understand how the requirements of the healthcare customer can be best supported by software development activities to avoid duplication of these activities during deployment. In other words, the idea was not only to focus on the functions, features, and the infrastructure requirements during software development, but also on the typical deployment strategies used in the healthcare industry; the overall objective being to supply software to the healthcare customer with supporting documentation to show that it had been fully specified and verified.

## Release Planning

The release planning phase was the initial phase of the project.

The need for a system was identified with an understanding of the business case and processes to be supported by the system. The scope of the project, the risks involved, business benefits, validation and compliance approaches, and current technologies were examined. Also an extensive analysis of the relevant regulations (EMEA, US FDA), including 21 CFR Part 11 requirements was executed in this early stage to ensure a top-down, risk-based approach for covering these requirements and enabling a ready-to use application and implementation.

The regulatory impact of the system must be understood, and a comprehensive and holistic approach to achieving compliance is an essential part of the planning phase for regulated compliant solutions. Therefore, a solution based on the GAMP® 5 Guide<sup>1</sup> was established, which associated development activities with subsequent customer activities during deployment. This was in order to help customers avoid duplication of unnecessary specification and verification activities during deployment. Also it was very important to define and cover different configuration items for the software solution at this early design phase of the system.

This Standard Release concept is shown in Figure 1; the standard release was fully specified and verified according to GAMP software Category 5 requirements (custom build software). The only difference being that the user acceptance testing phase was executed with a “virtual standard customer.” This Standard Release contained all essential deliverables and executions, starting with the requirement specifications, functional specifications, technical specifications, software development, and several test phases from developer’s test, system test, and acceptance test.

While the requirements were derived from various user requirements and also technical aspects and industry standards, at this stage of the development life cycle, they were called System Requirements. This is a significant advantage at the time the standard software is subsequently applied as part of a customer project – at that point, the user requirements can be mapped to the systems requirements, and gaps can be easily identified without the necessity to always analyze the functional and technical details.

The Standard Release also included a risk management plan, user and administration manuals, and other supporting documentation, like standard templates and white papers. This approach forms the basis for saving time and effort during deployment and implementation for each customer rollout.

At the end of this process, the Standard Release was fully specified and verified and could be used, with all associated documentation deliverables, as the technical basis for any customer project. The project implementation is described in detail later in this article.

Each customer project can be handled as GAMP software Category 4 (configured product) and additionally, from a supplier’s perspective, multi-client projects can be handled and organized from a release, maintenance, service, and project management point of view.

## Quality Planning and Compliance Concept

Based on a certified Quality Management System, this Stan-

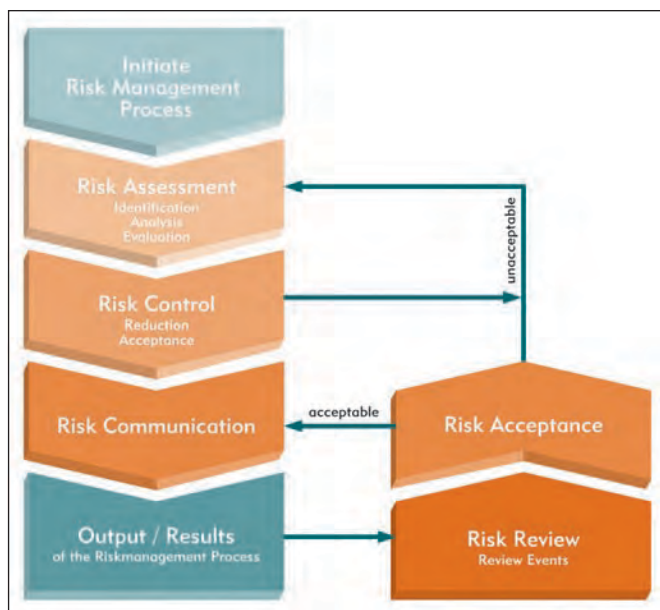

Figure 2. Quality risk management (software development).

standard Release concept was established within a framework of procedures and work instructions for project and release management, specification, verification, and software development. The basic concept was planned and documented with a detailed Release Quality Project Plan, where roles and responsibilities, project and documentation tasks for each release step were defined. Each stage required the involvement of Subject Matter Experts (SME), for different interdisciplinary areas like applicable regulations, basic and technical design, compliance, support (hand over processes), and documentation.

A risk management plan included an analysis of the applicable predicate rules for the weighing process and execution based on other guidelines like *ICH Q9*<sup>9</sup> for a risk-based approach - *Figure 2*. The risk analysis was executed with the *Failure Mode and Effects Analysis (FMEA)* methodology based on a detailed process description and mapping (within the project team, this analytical approach of severity, occurrence, and detection was very quickly seen as an excellent tool for system design and requirements setup). Also the level (number) of severity could be ranked as the GxP impact, and the level of occurrence and detection could be reduced by system control or preventative actions. This approach enabled an early “quality by design” process related to the IT system.

Each process step was examined for possible failures in a process design – quality and reliability – the release and quality team received much information about how to alter the system functions, software development, or manufacturing process in order to avoid these failures. Actions for risk reduction (or risk mitigation) were setup in the scope of system functions, which had to be defined in the system requirements and functionally described in the corresponding functional specifications. These so called system requirements were the “user requirements” for the standard release. This working process was continued within the iterative risk process until a pre-defined acceptable risk ranking was achieved. This ap-

proach also was essential for the verification and test planning, because relevant system functions were identified and classified on their relevance to their risk reduction factor.

The requirements analysis phase, in parallel with the risk management activities, encompassed both the regulatory and functional requirements of the system from the customers’ perspective and the technical requirements from the developers and implementers’ perspective. Functional requirements identify the expected capabilities of the system for risk reduction, capturing what the system will do without defining how it will do it. Therefore, the Functional Specification was written on the basis of so called Use Cases, where the real process was transformed into a system process in terms of sequential setup of workflows (user wizards). These technical requirements like wizard work flows, system plausibility checks, and control functions identify the technical conditions necessary for compliant operation of the system for the future use within the regulated environment.

The intent of the design phase was to capture how the requirements would be met - *Figure 3*. The functional and technical requirements identified during the requirements analysis phase were translated so that the proposed system could be described in terms of software objects down on each field level, such as database tables, data requirements, and program components (i.e., windows, buttons, fields, functions, prompts, constraints, interfaces, etc.). In addition, this level of detail ensured a better transfer of information to the software developers and enabled a higher level of possible software testing in the subsequent verification processes.

For this process of requirements and testing management, the Extensible Mark-up Language (XML) was chosen, individually customized, and used. In general, XML is a general-purpose specification for creating custom mark-up languages that allows its users to define their own elements. Its primary purpose is to help information systems share structured data and it is used both to encode documents and to serialize data.

The test script generation for the related test phases was automated so that any change cycles could be executed more quickly and effectively. A correlation was maintained between the elements of the various phase deliverables and supporting documents; for example, the correlation between the system requirements and functional design/specification and the test cases that challenge them. This structured data handling facilitates maintenance of the cross-referencing between predicate rules, requirements, the corresponding software elements and the test cases that challenge them, as well as the software code.

## Software Development

As a result of the risk-based functional and technical process, the release development team started to create code. The Software Development Lifecycle (SDLC) was composed of phases during which the software system was conceptualized, created, implemented, and maintained. Each technical description was logically broken down to development orders that were assigned to individual developers. A workflow management

*Continued on page 64.*

tool handled these working packages, where pre-defined steps, like development analysis (i.e., analysis of side impacts, etc.), module specification, and unit testing were executed. Also this process ensured that each development and code generation was executed by at least two independent persons, under control of the lead developer. Additionally, the source code entries were referenced and managed by a source code management tool, which also offers many more capabilities for code generation and testing. GAMP@5 references different standards such as Capability Maturity Model® Integration (CMMI®<sup>3</sup>) and ISO 12207<sup>4</sup> (software process models). Both models give a detailed methodology and structure for software development and should be used as guidance documents for assessing, analyzing, and improving the current software development workflow or to set up a new framework.

The development workflow enabled clear project control and status, because the software development was divided into logical working units with separate status of each development package. After all development orders were completed, the development phase was finalized and the first release build was available for system testing. Release management and a final development report for each release or build were essential for the test execution on a test environment.

During the system testing phase, verification against the written technical specification was performed to ensure that the use case flow, user and system interfaces, and different configuration item settings were technically correct and in alignment with the technical and functional requirements. Testing was documented via organized test plans and scripts – referenced to the specifications by unique ID numbers and a final test report of the results was produced.

A quality report and a certificate were issued for this fully specified and verified Standard Release, which stated all the activities, results, created deliverables and actions during software development.

As described earlier in this article, this Standard Release can now be used for customer projects and implementations. An additional product white paper and a supplier audit offer the possibility to assess this approach for subsequent usage by the customer during system deployment and implementation.

## Project Implementation

The project implementation phase comprises the activities required to coordinate the controlled and successful rollout of the system into the client's environment and to determine that the system fulfils the specific requirements.

Based on the fully specified and verified Standard Release concept, a basic workflow for the project implementation can be defined. The first and most important step is to compare the customer requirements, normally written down in a User Requirement Specification by the customer or optionally within shared workshops along a prototyping concept with the corresponding system requirements and functions of the standard release. This Gap Analysis between customer's user and system requirements and the standard release specification determines whether:

- standard release function covers the requirements
- customer-specific requirements need to be realized by configuration
- customer-specific requirements need to be realized by development or code change

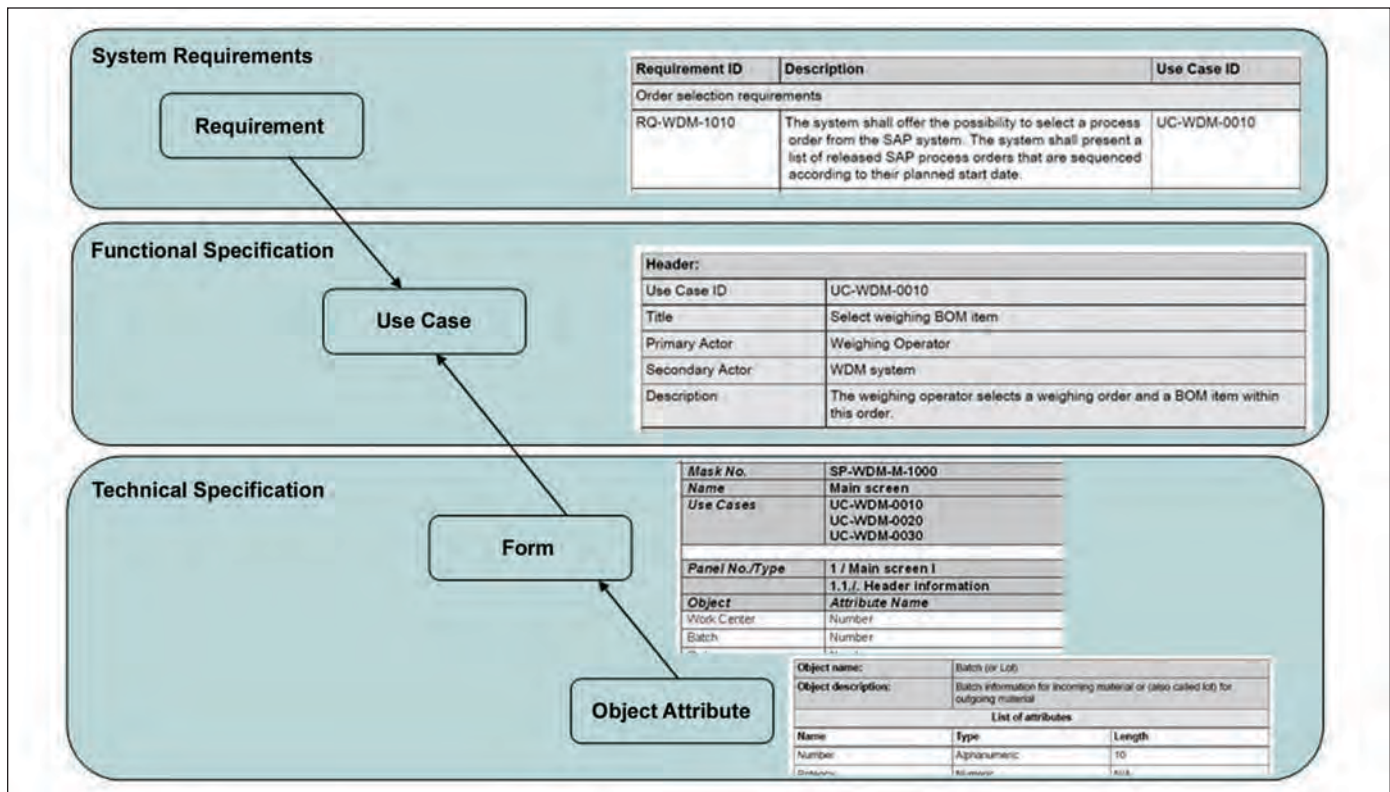

Figure 3. System specifications and design documents.

The result of the Gap Analysis is an important input into the implementation and project setup.

Typically, about 80 to 90% of the requirements can be covered by the standard release or by configuration of specific configuration items. This implies that the implementation can be managed following the approach for GAMP software Category 4. The remainder of the functionality must follow the approach for GAMP software Category 5, where the main efforts of the customer can be concentrated during specification and verification.

Most specification and verification has already been completed during the software development and release stage and the development workflow and tools are already established during the standard release period. The customer implementation phase should follow pre-defined processes, and be based on identified risks. The customer's Validation Plan should reference the Standard Release Quality Project Plan, and describe how supplier documents are to be leveraged.

This approach is beneficial in terms of software quality, meeting regulatory requirements, quality risk management, process control, and project time and costs. It also assists the supplier with system and operations support and multi-customer relations (e.g., bug-fixing, release, and upgrade management).

## Conclusion

In today's world, features and functions of software are not the only important aspects when selecting the most suitable and most efficient software solution. The best balance needs to be found between the following aspects:

- requirements and functional match
- compatibility with a common IT solution framework and infrastructure
- implementation time
- achieving and maintaining compliance with regulatory requirements
- interoperability between systems.

However, it is the end users challenge to select the right solution, which these days is not only defined by the operating system or database – it also is influenced by the most common and dominant software solutions within the overall IT landscape. It is the responsibility of software vendors to adopt the most appropriate development strategies, which allows for fast deployment, seamless integration, “ready-to-run” configurations, and provision of appropriate specification and verification documentation. Benefits of the approach described in this article include:

- single set of master data
- no interfaces and synchronization
- one IT systems landscape
- rapid deployment based on pre-configured, specified, and verified solutions
- industry specific implementation methods

## References

1. *GAMP® 5: A Risk-Based Approach to Compliant GxP*

*Computerized Systems*, International Society for Pharmaceutical Engineering (ISPE), Fifth Edition, February 2008, [www.ispe.org](http://www.ispe.org).

2. ICH Q9-Quality Risk Management – International Conference on Harmonisation of Technical Requirements for Registration of Pharmaceuticals for Human Use, 2005.
3. CMMI® for Development (CMMI-DEV), Capability Maturity Model® Integration, Technical Report CMU/SEI-2006-TR-008, Software Engineering Institute, 2006.
4. ISO 12207; (ISO/IEC 12207:2008), Software Life Cycle Processes, International Organization for Standardization, 2008.
5. Product white paper: SYPROS WDM – Systec Production Suite Weigh and Dispense Management based on SAP MII® and SAP NetWeaver® platform.

## About the Authors



After studying physics, **Markus Roemer** started his career at Vetter Pharma Fertigung as a computer system validation specialist and joined Rockwell Automation Propack Data in 2001. Since 2003, he has been working in various global validation and consultancy functions in the pharmaceutical industry. He has a wide range of validation knowledge and experience

in aligning IT compliance, quality risk management, software development, and quality management systems. Before joining Systec & Services, Roemer was Senior Validation Consultant at Invensys Validation Technologies, Montreal and headed different local and global positions. In his current position as Director Compliance Management at Systec & Services, he oversees consultancy services for IT Management and Compliance, Validation, and Quality Management. Roemer is ISPE Ambassador of the DACH Affiliate. He can be contacted by telephone: +49-751-3545-0890 or by email: [roe@systec-services.com](mailto:roe@systec-services.com).



**Hermann Schaefer** has worked in the software solution business focused on the life sciences industry for the past 15 years. He was responsible for a number of global projects and rollouts as part of multi-international organizations. He knows the requirements and specifics of production management systems for the commercial manufacturing, R&D, and Clinical Studies and

Supplies. Previously, he worked in various roles in Professional Services, Business Management, and Sales, both on a national and international basis. Before starting at Systec & Services, Schaefer was a Vice President and part of the Executive Management Board at POET AG and before that he led the European Sales team in the Life Sciences Vertical at Rockwell Automation's Information Solutions group. Currently, he is a Managing Director at Systec & Services GmbH, responsible for sales, marketing, consulting, and research and development. He holds a BS in electrical engineering. He can be contacted by telephone: +49-721-6634-360 or by email: [hes@systec-services.com](mailto:hes@systec-services.com).

Systec & Services, Emmy-Noether-Str. 9, Karlsruhe, 76131 Germany. 

Supplement to

**PHARMACEUTICAL  
ENGINEERING**

**2009**



# Facility of the Year Awards CATEGORY WINNERS



ENGINEERING PHARMACEUTICAL INNOVATION

[www.ISPE.org](http://www.ISPE.org)







## Cover Photographs

Photos courtesy of Aseptic Technologies, Centocor Biologics Ireland, Centocor R&D Schaffhausen, hameln pharma, Orchid Chemicals & Pharmaceuticals, and Roche Pharma Biotech Production Basel

**ISPE HEADQUARTERS**  
3109 W. Dr. Martin Luther King Jr. Blvd.  
Suite 250  
Tampa, Florida 33607 USA  
Tel +1-813-960-2105  
Fax +1-813-264-2816

**ISPE ASIA PACIFIC OFFICE**  
73 Bukit Timah Road  
#04-01 Rex House  
Singapore 229832  
Tel +65-6496-5502  
Fax +65-6336-6449

**ISPE CHINA OFFICE**  
Suite 2302, Wise Logic International  
Center  
No. 66 North Shan Xi Road  
Shanghai 200041, China  
Tel +86-21-5116-0265  
Fax +86-21-5116-0260

**ISPE EUROPEAN OFFICE**  
Avenue de Tervueren, 300  
1150 Brussels, Belgium  
Tel +32-2-743-4422  
Fax +32-2-743-1550  
[www.ISPE.org](http://www.ISPE.org)



Any reproduction of the contents of this supplement in whole or part is strictly forbidden without the written permission of ISPE. Views and conclusions expressed in articles herein are those of the authors and not necessarily those of the editorial staff, officials and Board of Directors of ISPE.

©2009 International Society for Pharmaceutical Engineering. Pharmaceutical Engineering and the logo appearing throughout this magazine are registered trademarks.

## Supplement to PHARMACEUTICAL ENGINEERING®



## Articles

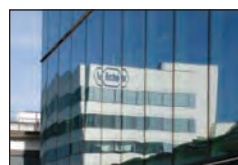
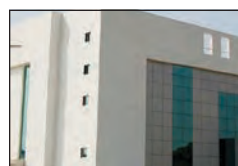
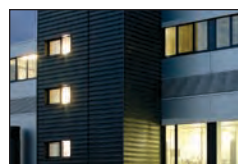
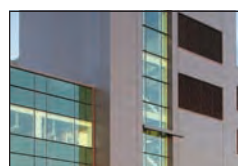

- 4 Introduction**  
*2009 Facility of the Year Awards Program Reaches New Heights*
- 6 Category Winner – Equipment Innovation**  
**Aseptic Technologies**  
*Crystal Clear Aseptic Filling*
- 10 Category Winner – Sustainability**  
**Centocor Biologics Ireland**  
*The Value of Sustainability*
- 18 Category Winner – Facility Integration**  
**Centocor R&D Schaffhausen**  
*Superior Integration Shortens Bridge from R&D to Commercial*
- 26 Category Winner – Operational Excellence**  
**hameln pharma**  
*Every Step Counts Toward Operational Excellence*
- 32 Category Winner – Regional Excellence**  
**Orchid Chemicals & Pharmaceuticals**  
*A Model Facility for the Pharmaceutical Industry in the Region*
- 36 Category Winner – Project Execution**  
**Roche Pharma Biotech Production Basel**  
*Skillful Orchestration of a Complex Project*
- 44 Honorable Mention**  
**GlaxoSmithKline**  
*Advancing the Aseptic Powder Filling Process*



Daldrop + Dr. Ing. Huber congratulates Hameln Pharmaceuticals and Roche Pharma on their "Facility of the Year Award 2009"



Daldrop + Dr. Ing. Huber planned and built the entire cleanroom technique of the award winning building infrastructure Hameln Pharmaceutical Neurosterile Production Plant and Roche MAB Building 95 using the SHELMEQ® system. Conventional cleanroom building procedure is for the floors, walls and ceilings to be designed by architects and the building services by consulting engineers. The revolutionary SHELMEQ® system by Daldrop + Dr. Ing. Huber handles both the physical infrastructure as well as the cleanroom conditions out of one hand thus eliminating possible interface disturbances.

Daldrop+Dr. Ing. Huber  
Daldropstraße 1  
72666 Neckartailfingen  
Germany

Phone: +49 7127 18 03-0  
Telefax: +49 7127 38 39

varipro@daldrop.com  
www.daldrop.com

## 2009 Facility of the Year Awards Program Reaches New Heights

**N**ow in its fifth year, it is not an exaggeration to say that the Facility of the Year Awards (FOYA) program reached new heights in 2009. Along with garnering increased industry visibility – having been covered by an ever-increasing number of international and industry publications – the FOYA program also has solicited submissions from the best and brightest from around the world. Submissions during the past five years have been received from more than 20 different countries and territories. This year alone, the program received submissions from innovative facilities built in Belgium, France, India, Italy, Ireland, England, Germany, Japan, the Netherlands, Spain, Switzerland, and the United States.

Co-sponsored by ISPE, INTERPHEX, and *Pharmaceutical Processing* magazine, the awards program effectively spotlights the accomplishments, shared commitment, and dedication of individuals in companies worldwide to innovate and advance pharmaceutical manufacturing technology for the benefit of all global consumers. The 2009 Category Winners, as well as each of the submitters, literally and brilliantly embody this sentiment.



Aseptic Technologies: Filling and laser re-sealing in capping area of workshop.

**Aseptic Technologies** – determined to resolve the incidents of product contamination that are reported in the industry each year – developed the innovative, new Crystal® Closed Vial technology for aseptic filling of injectable products. Taking its solution one step further, the company installed the associated equipment in its own Gembloux facility as a way to help clients obtain stability data without accepting the financial risk of implementing the new technology themselves. Taking such a unique approach to a critical industry issue and tackling the complexities of vial component preparation was not only ingenious, but also will help patients worldwide.



Centocor Biologics Ireland: Facility to capture rainwater from roofs within a grey water recovery system for future use in sanitary and ancillary process applications.

**Centocor Biologics Ireland** went to extraordinary lengths to ensure that its BioCork facility in County Cork met or exceeded standards for energy-efficiency and sustainability with the utilization of a biomass boiler, an advanced membrane waste water treatment facility, recycled rainwater capabilities, and extensive landscaping that mitigated the visual impact of such a large facility in a largely residential area. Not only is the facility 40% more energy-efficient than internal benchmarks, but it was also one of the safest large projects ever built in Ireland.

Facility integration was the objective for **Centocor R&D Schaffhausen** as it smoothly incorporated its new fill finish pilot plant into its existing Schaffhausen campus with a fast-track approach that allowed the talented project staff to complete the facility within 30 months. The F2P2 project contributes significant advances to the pharmaceutical manufacturing industry by creating a unique solution for a multi-product, multi-format R&D clinical fill finish



Centocor R&D Schaffhausen: Syringes being transported to the sterilization tunnel.

facility in a strategic location on an existing site.

The planning of **hameln pharma's** streamlined 9200-square-meter sterile production facility began in March 2006 with lean production concepts leading the way. The standardization of rooms, equipment, inventory, production resources, and processes throughout design and construction led to a successful project completion in only 25 months, significant increases in employee productivity, and the efficiency of hameln's entire production process.



hameln pharma: Filling and closing of vials, Class A/B. These fixed gloves used for interventions together with a continuous airflow from Class A to the outside of the room and doors with safety locks ensure an extremely clean environment.

When **Orchid Chemicals & Pharmaceuticals** began to create a new facility with modern and flexible cGMP aspects to manufacture internationally acceptable products, its staff knew that new technologies would be necessary; and they met the bold challenge successfully. With the high degree of facility automation, innovative energy conservation measures, and one of the first cGMP operational systems for bulk API handling in India, Orchid has become a model for other organizations building facilities in the region.



Orchid Chemicals & Pharmaceuticals: Production blocks are well integrated.

Finally, the project team at **Roche Pharma Biotech Production Basel** shined while delivering an ultra fast-track, completely unique, vertical MAB facility on the site of a former chemical plant in the middle of a busy Basel residential area.

Every aspect of this project had to be flawlessly executed to accommodate the many challenges of the site, location, and facility design. The result was a skillfully orchestrated project delivered six weeks ahead of an already aggressive schedule.

Each of the impressive submissions was reviewed by an independent, blue-ribbon judging panel of global representatives from the pharmaceutical design, construction, and manufacturing sectors. The judging panel was comprised of professionals who have hailed from and participated in pharmaceutical facility construction projects throughout the world.

The following are the members of 2009 Facility of the Year Awards Judging Panel:

- **Andy Skibo, Judging Panel Chair** – Senior Vice President Global Engineering and Facilities, MedImmune
- **Jim Breen** – Vice President Project Management, Johnson & Johnson
- **Chaz Calitri** – Senior Director Global Engineering, Pfizer
- **Brian H. Lange, P.E.** – Director of Engineering, Merck & Co. Inc.
- **Geoff Monk** – Vice President Global Engineering Services, Schering-Plough
- **Jon Reed** – Vice President Corporate Engineering, Genentech
- **Ron Trudeau** – Vice President Facilities Engineering, Baxter Healthcare
- **Shinichi Osada** – General Manger, Hitachi Plant Technologies, Ltd.

“The judging panel was truly impressed with the quality of this year’s submissions, as well as the depth and breadth of each organization’s innovative solutions for pharmaceutical manufacturing challenges,” said Robert P. Best, ISPE President and CEO. “It seems that each year the most talented minds in the industry raise the bar for quality, creativity, and ingenuity... which will ultimately benefit people worldwide,” said Best.

**For more information about the Facility of the Year global annual awards program, visit [www.facilityoftheyear.org](http://www.facilityoftheyear.org).**



Roche Pharma Biotech Production Basel: Space between structures max. 25 feet.

## Aseptic Technologies

# Crystal Clear Aseptic Filling

### Introduction

To address the complexities inherent in conventional glass vial filling processes that can increase the risk of contamination to sterile products, and ultimately to patients, Aseptic Technologies developed the new Crystal® Closed Vial technology for aseptic filling of injectable products.

To showcase this new technology to potential clients, Aseptic Technologies, a developer and manufacturer of aseptic production equipment for the pharmaceutical and biotech industries, built the **GMP Manufacturing Site for Aseptic Filling** in Gembloux, Belgium – winner of the **2009 Facility of the Year Award (FOYA) for Equipment Innovation**.

### Facing Challenges with Innovation

Aseptic processing in general has long been considered by many in the pharmaceutical industry to present unique and difficult challenges.

The conventional glass vial filling operation in a cleanroom has reached a high level of complexity to ensure safe processing. Vials and stoppers need to be prepared prior to filling, which consists of WFI washing and sterilization either with steam (stoppers) or in depyrogenation tunnel (vials). High speed stoppering and aluminum cap crimping generate many short stops.

Human activities required to execute the process significantly increase the risk of contamination. It is estimated that personnel represents the highest risk of contamination due to either the presence of contaminants on operating personnel or due to mistakes made during sanitization and operations<sup>1</sup>.

To address these challenges, Aseptic Technologies, a subsidiary of Glaxo SmithKline Biologicals, developed the new Crystal Closed Vial technology for aseptic filling of injectable products. Since this technology was completely new, in March 2005, the company decided to install the first Crystal Closed Vial Filling Line (CVFL) in a new facility and operate it as a contract manufacturing organization offering filling of stability

## Aseptic Technologies

Category Winner – Equipment Innovation

**Project:** GMP Manufacturing Site for Aseptic Filling

**Location:** Gembloux, Belgium

**Size:** 4,306 sq. ft. (400 sq. m.) filling suite, 8,611 sq. ft. (800 sq. m.) other

**Total Project Cost:** US \$4.98 million

**Duration of Construction:** 16 months



Filling line in the filling room.

batches for clients who wish to investigate the stability of their product inside a Crystal® vial.

In 16 months, Aseptic Technologies constructed the GMP Manufacturing Site for Aseptic Filling in Gembloux, Belgium. The site is composed of two buildings: AT01, which is dedicated to offices, meeting rooms, and workshops and AT02, which includes a workshop, offices, and the filling facility.

The 400 m<sup>2</sup> filling suite includes all the necessary equipment to perform aseptic filling. The operations performed in the suite are:

- Raw Materials – reception and storage
- Material Preparation – a washing room with double door autoclave is dedicated to the preparation of the filling needle and the tubing attached to it.
- Filling – a Class 100,000/Grade C/ISO 8 cleanroom is equipped with a CVFL with a capacity of 1,500 vials/hour. This line is able to handle batches from a few thousands up to 20,000 vials per batch.
- Downstream Processing – all downstream processing (particle inspection, labeling, and packaging) are manually performed because Aseptic Technologies target small batch filling, such as stability and initial clinical batches.
- Quality Control Laboratory – the few in-process quality control operations are performed inside the laboratory.

### The Technology

The closed vial technology is based on a vial provided with the stopper in place. The vial manufacturing process has been optimized to ensure that the vial is clean inside and sterile by use of cleanroom production and sterilization by gamma-irradiation. This specific manufacturing process generates ready-to-fill containers, eliminating washing, sterilization, and depyrogenation

– the most complex filling steps of conventional open vials.

The filling is done by means of a needle piercing the stopper and dispensing the liquid. After needle withdrawal, the puncture trace is immediately resealed with a laser to restore the closure integrity.<sup>2</sup>

## The Vial

The closed vial is a container composed of five elements:

- Vial Body – Cyclo-Olefin Co-polymer (COC) is used to produce vial bodies. This plastic was selected because of its excellent barrier and transparency properties, making it one of the most renowned plastics for containers in the pharmaceutical industry. Two different technologies are used to produce vial bodies: injection molding for small vials and injection blow molding process for larger ones.
- Stopper – made of a specific ThermoPlastic Elastomer (TPE) able to absorb laser energy and to melt when temperature exceeds 133°. This melting property is used to reseat the needle puncture trace to restore the closure integrity.
- Top Ring – secures the closure integrity of the assembly of the vial body and the stopper with non-return right angle snap fits.
- Bottom Ring – ensures good stability of the vial and firm holding during piercing and needle withdrawal.
- Cap – polyethylene cap, equipped with a circular rib pressing on the stopper surface, has the property to protect the

## Why Our Project Should Win

The following is an excerpt from Aseptic Technologies' submission, stating, in their own words, the top reasons why their project should win the 2009 Facility of the Year Award:

- First facility implementing the innovative Crystal® Closed Vial technology aiming to improve the quality for patients
- Simple operating environment with elimination or dramatic simplification of the major sources of complexity for classical aseptic filling facilities
- Inexpensive installation with very limited capital resources to be injected in the project
- Fast implementation with less than two years from management decision up to final inspection by authorities
- Strong attention and support from global regulatory authorities as illustrated by interest from both the US FDA and EMEA

piercing area by keeping it in a Class 100/Grade A/ISO 5 environment until use by the health professional. This specific characteristic avoids the contamination of the stopper surface after filling and during vial storage and transportation.

*Continued on page 8.*

According to **EUROPEAN COMMISSION ANNEX 1** (regarding the manufacture of sterile medicinal products) any product in a partially stoppered freeze-drying vial that has been filled aseptically and is to be freeze-dried should be maintained within the ISO Class 5 environment, from the point of stopper insertion to the freeze dryer.

**This requirement should be implemented in the United States by March 1, 2010.**

## EnGuard Systems Transfer Carts

EnGuard Systems Transfer Carts provide the ISO Class 5 environment during the transportation of products through uncontrolled areas.

- A closed, sealed environment for storage and transfers
- Interiors and exteriors meet cGMP cleaning requirements
- Finished to pharmaceutical standards
- Membrane-protected HEPA filter
- HEPA-filtered, unidirectional air flow
- Manual or VHP decontamination
- Battery charging via standard wall outlet



EnGuard  
Systems  
Transfer Cart

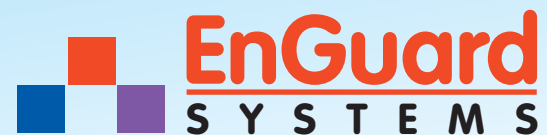

**INTERPHEX BOOTH 2480 ■ 317.443.3723 ■ www.enguardsystems.com**

## Notes from the Judging Panel – What Impressed Them

*Equipment is very innovative.  
They have an interesting concept for  
quality improvement of vial filling.*

Not only is the material and design of the vial innovative, but so is its manufacturing process, according to Aseptic Technologies. To ensure cleanness and sterility, the vials are molded and stoppered by robots in a cleanroom Class 100/Grade A/ISO 5 and then sterilized by gamma-irradiation. The manufacturing of the vials comprises the following steps:

- The vial bodies and the stoppers are molded at the same time in two molds installed in a cleanroom Class 100/Grade A/ISO 5.
- Immediately after mold opening, two robot arms pick the vial body and stopper and bring them in front of each other. The assembly is performed by simple pressure of the two elements. This assembly creates closed vials with Class 100/Grade A/ISO 5 air inside.
- The vials are then transferred by one of the robot arms to an adjacent cleanroom Class 100,000/Grade C/ISO 8 where the addition of top and bottom rings are performed by a full automatic machine. All assembly steps are automatically controlled to eliminate the vials with one of the elements missing or misplaced.
- After packaging, the complete pallet is gamma-irradiated at a minimum dose of 25 kGray.

This process provides vials with extremely high quality in terms of stability and both particle and endotoxin contamination. Therefore, any additional step, such as washing and depyrogenation, are deemed unnecessary and the vials are provided ready-to-fill.

### The Filling Line

The filling of the vial is performed on a dedicated filling line equipped with specific technologies. The complete filling process, from delivered vials to filled and capped vials, comprises five steps:

1. Loading – the operator loads the vials from polyethylene boxes using semi-automatic opening equipment. Therefore, the risk of contamination by the operator is strongly minimized.
2. Top Surface Sterilization – as the loading is still manual, the sterility of the stopper surface can be jeopardized by human error. Therefore, an e-beam (beta-irradiation or electron beam at 25 kGray) is used to re-sterilize the most critical surface – the stopper surface which will be in contact with the filling needle during piercing. After the e-beam, the vials directly enter a barrier that maintains a Class 100/Grade A/ISO 5 environment during all filling operations.
3. Filling – a 13-gauge needle with a pencil point and two exits with 30° angle pierces the stopper, dispenses the volume of

liquid, and comes out by lifting. The needle was designed specifically to 1. eliminate a coring effect in the stopper and to minimize the generation of particles during piercing, 2. dispense the liquid smoothly to avoid damages for sensitive products (e.g., proteins) during filling, and 3. properly cut the TPE to ensure optimal laser resealing. The side wall of the needle is equipped with four grooves to vent overpressure generated during filling.

4. Laser Resealing – to fully restore the closure integrity, the resealing of the pierced stopper is performed by a laser dispensing 6.5 W/s. This laser shot increases the temperature of the stopper surface up to 165°C to melt the material which then fuses and restores closure integrity as it cools. The melted stopper material fully recovers its initial characteristics in terms of elasticity and resistance. By using a low energy laser, the energy is absorbed on the top surface of the stopper and does not reach the product. This is achieved by adjusting the laser wavelength and the absorption characteristics of the TPE. Product safety was confirmed; temperature inside the vial was measured and no change was recorded in the liquid after a laser shot.
5. Capping – using plastic caps with the snap fit technology, capping is easily performed without need for crimping.

The first two steps are performed under a laminar airflow delimited by soft walls. The last three steps are made in a Closed Vial Filling System (CVFS) with access only through gloves and rapid transfer ports. As the doors can not be open and direct access is forbidden for operators, a high quality of Class 100/Grade A/ISO 5 environment is permanently ensured. Isolators and closed RABS can be used for classical products, but become mandatory to protect the operator from contamination by specific products, such as cytotoxics, bio-hazard, and radioactive products.

### Key Advantages of the Technology

When comparing conventional glass vial technologies to the closed vial technologies, key advantages can be identified.

#### ***Better Sterility Assurance Level and Reduced Particle Presence***

The most important advantage is an increase in quality for the patient, observed for both sterility assurance level and particle presence.

A higher sterility assurance level is obtained through the concept of always keeping the vial closed. This reduces the risk of a contaminant penetrating the container. In the conventional glass vial filling process, opened vials and free stoppers can be exposed up to a few hours, for example, when large batches of stoppers are used. Regarding particle presence, the full process with the closed vial generates a very limited amount of particles, twice less compared to glass vial filling processes.

Another advantage for the patient is a newly designed capping technology. The entire stopper surface is protected by a circular rib, located on the inner face of the cap, which creates additional closure integrity.



Crystal® clinical line in workshop before delivery.

## Simplified Filling Operations

Several glass filling equipment become obsolete with the closed vial technology, including:

- The washing stations for both vial bodies and stoppers are unnecessary.
- Because of the absence of washing, consequently there is no need for Water For Injection (WFI) on the filling line, eliminating a major source of expense, validation work, and risk of batch reject.
- The sterilization tunnel, with its high consumption of energy and difficulties for validation, is eliminated.
- The stoppering station, a source of frequent short stops, is replaced by the laser resealing station.
- The capping station, using simple snap fit technology, is simplified and more productive compared to the crimping station used for the aluminum cap.

The e-beam sterilization and laser resealing stations are two new technologies added to the closed vial filling process that are not on the conventional glass filling line. These technologies have been designed to ensure full compliance with the most advanced current Good Manufacturing Practices (cGMPs), such as Process Analytical Technology (PAT). A filling line can be installed in a building just equipped with electricity. WFI is only needed to prepare the filling equipment in the washing room and to autoclave the needle assembly.

### Key Project Participants

**Architect:** Somville, Presciutti, and Partners, Fleurus, Belgium

**Construction Managers:** Christian Vandecasserie, Director, and Françoise Delhalle, Responsible Pharmacist, both of Aseptic Technologies, Gembloux, Belgium

**Main/General Contractor:** Cobelba, Naninne, Belgium

**Piping and HVAC Subcontractor:** D-FI, Sprimont, Belgium

**Automation and Control Supplier:** Honeywell, Diegem, Belgium

**WFI Generator Supplier:** Millipore, Brussels, Belgium

**Autoclave Supplier:** Steritec, Brussels, Belgium

## Secured Supply Chain and Easier Handling

There are advantages linked to the innovative design of the vial, improving the supply chain until injection of the product. The vial body, made of COC, is resistant to shocks and can not be easily broken, conferring a higher safety assurance for the operators, practitioners, and nurses, especially when potent products are used. In addition, the stopper was designed to have a large and flexible piercing area and to favor the complete collection of the liquid by avoiding recess areas.

The design of the vial also allows online coding by either RFID chip installation or laser coding before any operator has access to the vials.

## Reduced Capital and Operating Expenses

In terms of total cost of operation, filling in the closed vial was evaluated to be more cost-effective than filling in glass vials, in particular for expensive products, according to Aseptic Technologies. The following considerations were gathered in an evaluation Aseptic Technologies conducted with several companies:

- Using sterile and ready-to-fill vials adds a significant cost increase compared to classical components of glass vials which need to be cleaned and sterilized.
- However, capital expenses and one-shot expenses are reduced because of simplified equipment, reduction of cleanroom size, and reduction of resources and time allocated to validation.
- Operating expenses are reduced because of reduction of residual volume, reduction of vial breakage, and lower utility consumption.

## Conclusion

Determined to resolve the incidents of product contamination that are reported in the industry each year, Aseptic Technologies developed the innovative, new Crystal® Closed Vial technology for aseptic filling of injectable products. Taking its solution one step further, the company installed the associated equipment in its own Gembloux facility as a way to help clients obtain stability data without accepting the financial risk of implementing the new technology themselves. Taking such a unique approach to a critical industry issue and tackling the complexities of vial component preparation will help patients worldwide.

## References

1. Akers, James E. and James P. Agalloco, "The Akers-Agalloco Method," *Pharmaceutical Technology*, 2 November 2005, Volume 29, Issue 11.
2. Thilly, Jacques, Doris Conrad, and Christian Vandecasserie, "Aseptic Filling of Closed, Ready to Fill Containers," *Pharmaceutical Engineering*, March/April 2006, Volume 26, Number 2.
3. Verjans, Benoît, "A New Technology for Aseptic Filling of Injectable Drugs," *Controlled Environments*, October 2007. 



## Centocor Biologics Ireland

# The Value of Sustainability

### Introduction

To provide additional manufacturing capacity for two promising new drugs in their pipeline, Centocor Biologics Ireland embarked on a project to build a new cell culture and purification site in Ringaskiddy, County Cork, Ireland.

This complex project, dubbed BioCork, underwent careful and integrated planning, resulting in a facility that was completed ahead of schedule, under budget, and exceeds capability requirements in all areas, especially in the sustainability category. **BioCork** is the winner of the **2009 Facility of the Year Award (FOYA) for Sustainability**.

### Search Yields Greener Pastures

In 2001, Centocor, which develops and produces biopharmaceuticals to treat autoimmune diseases, started looking at options to provide additional manufacturing capacity for two promising new drugs in their pipeline, CNTO 148 and 1275. Centocor's existing manufacturing sites were built-out so it was necessary to consider a greenfield site.

In June 2004, after three years of study, Centocor approved funding to establish BioCork. Constructed in two years, BioCork includes four buildings, 264,000 square feet of manufacturing, utilities, warehouse, and lab/office space spread over a 100-acre greenfield site. BioCork is expected to provide manufacturing capacity for 180 kg-per-year of biologic API.

### Sustainability by Design

It was important to Centocor that the BioCork project be consistent with the company's values, which demand safety of personnel during construction and operation, involvement with the surrounding community, compliance with all regulatory requirements, and minimal impact on the environment.

Rather than add sustainability features to the project after the blueprints were drawn, this criteria was an integral part of BioCork's design, construction, and operation. The result: a plant that is 40% more energy efficient than internal benchmark biotech facilities and a 97% reduction in the carbon footprint versus fossil fuel.

### Centocor Biologics Ireland

Category Winner – Sustainability

**Project:** BioCork

**Location:** Ringaskiddy, County Cork, Ireland

**Size:** 264,000 sq. ft. (24,526 sq. m.)

**Total Project Cost:** \$586 million

**Duration of Construction:** 24 months



Aerial view showing landforms surrounding plant on east and south.

The following are key sustainability features at BioCork:

- Based on 2007 and 2008 operational data, BioCork's efficient design required 3.92 MMBTU/meter<sup>2</sup>/year to operate its 24,391 m<sup>2</sup> facility versus the average of 6.49 MMBTU/meter<sup>2</sup>/year needed at other Centocor biotech facilities.
- BioCork contracts its electricity from a company that provides wind power generation and operates a biomass fuel boiler. As a result, the facility has a carbon emission of about 250 tons per year compared to 8,415 tons per year using fossil-fuel derived electricity and burned fossil fuel for heat and steam.
- Twenty-two tons of nutrients per year are prevented from being discharged to Cork Harbor. An advanced membrane bioreactor wastewater treatment plant is designed to remove 11.6 tons per year of nitrogen and 10.5 tons per year of phosphorus, in addition to conventional pollutants, such as biological oxygen and suspended solids, before discharging the water into Cork Harbor. Removal of nitrogen and phosphorus reduces the plant's impact on algae growth in the harbor, designated as eutrophic sensitive waters.
- All construction and operating materials and wastes were recycled where possible.
- Facility captures rainwater from roofs within a grey water recovery system for future use in sanitary and ancillary process applications, e.g., boiler makeup water and flushing toilets.
- Highest efficiency (90%) Reverse Osmosis units to minimize water wasted.
- Sophisticated rainwater and runoff containment, monitoring, and diversion system protect Cork Harbor from BioCork activities.

*Continued on page 12.*

# PM+CRB Congratulates Centocor BioCork

Winner of the Facility of the  
Year Award for Sustainability



"Environmental sustainability is a major challenge today and this award is a reflection of the dedication by Centocor and the PM+CRB project team to creating a world class manufacturing facility that also breaks new ground in sustainable design".

Lee Emel, Biotech Director, CRB

"We're delighted for both Centocor Biologics Ireland and the PM+CRB team that BioCork has been recognised with this award. Centocor and the design team worked hard to produce a sustainable facility, both in terms of its design and its operating efficiency and effectiveness".

Pat McGrath, CEO, PM Group

## PM+CRB Project Services

- Site Evaluation, Masterplanning and Permitting
- Architecture and Engineering Design
- Procurement
- Construction Management
- Commissioning and Qualification



## C O N T A C T

USA: Gary Reichelt +1 919 852 5400

Europe: Liam Foley +353 21 4358922

Asia: Fintan Cassidy +65 6513 1000

[www.pmggroup.eu](http://www.pmggroup.eu)

[www.crbusa.com](http://www.crbusa.com)

## A Global Alliance of Real Results

**PM**  
GROUP



CONSULTING ENGINEERS, INC. ■

PM+CRB is a worldwide alliance between PM Group and CRB Consulting Engineers. We provide a full range of project delivery services to the biopharma sector. With combined resources of over 2,200 personnel in 21 offices globally, we provide customer teams that are 'on the ground' in the United States, Europe and Asia.

- Energy efficient Variable Frequency Drives (VFD) on air handling units, chillers, pumps, and compressors.
- Lighting is controlled by occupancy sensors throughout the site.
- Eighty percent recirculation of air within cleanroom air-handling units.

## Why Our Project Should Win

The following is an excerpt from Centocor Biologics Ireland's submission, stating, in their own words, the top reasons why their project should win the 2009 Facility of the Year Award:

- Sustainability – sustainability is an integral part of BioCork's design, construction, and operation. The cumulative effect of these efforts will ensure significantly less energy and water usage than comparable facilities with less waste leaving the site.
- Project Execution – the entire BioCork Team focused on meeting the overall project objectives using an integrated approach to project execution that enabled this project to reflect Centocor's values, including contractor and operator safety; involvement in the community; compliance with all regulatory requirements; minimizing impact on the environment, exceeding performance requirements, and completing qualification ahead of schedule and under budget.
- Facility Integration – by including user input for all aspects of the project from concept through completion, the BioCork project closely reflects user's technical and aesthetic requirements. Features such as sufficient staging area for clean and dirty equipment, the ability to do almost all routine maintenance outside the cleanrooms, and the incorporation of ergonomics into selection of equipment and room layouts are all included as requested by the users. The workers can appreciate the spectacular natural setting of Cork Harbor with views from process, laboratory, and public spaces.
- Exceeded Capability, Schedule, and Budget Goals – through use of integrated budgeting and scheduling coupled with full user participation, this complex project was completed ahead of schedule, under budget, and exceeded capability requirements. BioCork allows Centocor to reliably supply patients with life saving and life enhancing drugs.
- Safety – through a coordinated and concerted effort, this site has achieved an exceptional safety record and developed a strong safety culture. Construction is a hazardous process. A project the size and complexity of BioCork, with more than 350,000 days worked, has countless opportunities for accident and injury. Through careful preparation, communication, and implementation of safety planning, BioCork is one of the safest large projects ever built in Ireland.



Biomass boiler fueled woodchip from sustainable forests.

- Gas-fired boilers are designed for biodiesel as an alternative fuel source.
- Recently commissioned biomass (woodchip) boiler will reduce the overall site CO<sub>2</sub> footprint by 3396 tons at maximum output (compared to natural gas).
- Wood used for the woodchip biomass boiler is sourced from renewable sustainable forests certified under the Forest Stewardship Program.
- Southerly alignment of the administration and laboratory areas facilitate passive solar heating.
- Groundwater monitoring wells and protection program monitors and protects groundwater resources in the locally important aquifer beneath the site.
- Applied energy management software monitors, trends, and manages energy utilization for improved energy efficiency, cost control, and reduction in carbon footprint.
- Innovative radiant cooling system and AHU heat wheels for office areas.
- Boiler stacks fitted with flue gas economizers.
- Cumulative impact of conservation techniques reduces boiler gas consumption by 60% and chiller electrical consumption by 30%.

## Considerate Neighbors

An environmental impact study was completed as part of the design process and an environmental impact statement was submitted to the Environmental Protection Agency. This considered the following impacts in detail: human; landscape and

*Continued on page 14.*

ProsCon – Automation Provider of Choice for Centocor



Coming from a multi discipline engineering background ProsCon is ideally placed to meet your Control System and Sustainability requirements.

ProsCon offer a comprehensive range of services to meet your facilities needs:

- **Control Systems** – PLC, DCS, SCADA, Batch
- **MES** – EBR, Historian, OEE, Material Tracking, EMI, Weigh & Dispense
- **Energy Management** – Energy Audits, M&T, Process Optimisation, Energy Reduction Projects
- **Sustainability** – Distillation, Solvent Recovery, Bio-Fuel Recovery
- **Process Design & Modular Build**

Contact: [salesteam@proscon.com](mailto:salesteam@proscon.com)

[www.proscon.com](http://www.proscon.com)

LISTEN.  
THINK.  
SOLVE.®



Allen-Bradley • Rockwell Software

**Rockwell  
Automation**

Copyright © 2009 Rockwell Automation, Inc. All Rights Reserved. AD 00000

## Notes from the Judging Panel – What Impressed Them

*The sustainability features, including traffic mitigation; offsetting carbon emissions; working with the community to mitigate visual impact; planting 70,000 trees; carbon footprint being reduced due to wind generated power; biomass facility; and rain capture ability, all noteworthy. They really utilized the strengths of the region. The logistics of working on the site were difficult, construction in/out and labor in/out was a challenge. The two-lane road in/out was a challenge and staging the trades was difficult for a project this size in this region. Good mix of local technology and overseas technology.*

visual; roads and traffic; soils, geology, and hydrology; flora and fauna; noise and vibration; water and effluent; air quality and climatic factors; waste management; material assets; archaeology; architecture; cultural heritage; and sustainability.

As a result of this process and consultation with residents in the area, it became apparent that the key concerns, beyond compliance with existing regulations, were the impact on traffic and the visual impact of constructing the plant.

Traffic impact was mitigated by instituting a Commuter Management Plan to reduce the impact of traffic during construction

when the maximum number of people would be entering and exiting the site. The project also involved extensive landscaping, including planting 70,000 trees to mitigate visual impact of the plant.

## It's All About Integration

Alongside its values, integrated planning, integrated project execution, and integrated teams, were essential parts of BioCork's platform.

## Integrated Project Execution

A project of BioCork's magnitude is often managed as distinct phases of engineering, procurement, construction, commissioning, qualification, and operation with different owner and vendor teams responsible for planning and executing those phases. Miscommunication and disconnects between phases can lead to schedule and budget problems and the need for significant corrective work at the end of the project.

The BioCork strategy was to integrate the teams, management techniques, and values across different phases and disciplines in order to proceed smoothly and efficiently from original concept to operable plant.

## Integrated Teams

Teams were integrated to minimize the number of handoffs from team-to-team by having key members participate in multiple phases, including:



- Vessel Design & Construction
- Modular "Plug & Play" Solutions
- Mobile Compounding Vessels
- Reactor Vessels
- WFI Vessels
- Fermentation Vessels
- Aseptic Vessels
- Stainless & Nickel Alloys



[www.kellsstainless.com](http://www.kellsstainless.com)

- Even before the permanent users were hired, a team of highly experienced temporary users were recruited from other Centocor plants to represent the user perspective during early design.
- Permanent users were hired early on and participated in design reviews, construction quality walks, and as hands-on members of the commissioning teams.
- Centocor’s lead engineers were full time “system owners” from concept design through commissioning ensuring continuity.
- A number of design engineers played lead roles on the FAT teams, field engineering support teams, and the commissioning teams.
- Key people from the construction management team were involved from early design through the end of commissioning.
- Quality personnel were heavily involved in reviewing construction and commissioning progress.



Media prep skid.

### Integrated Planning

It is common for large projects such as BioCork to meet schedule and budget objectives on one or more aspects of the project, but fail to meet overall schedule and budget. Delays occur when one critical activity does not complete as required for the overall schedule and opportunities are lost when subsequent activities are not ready to capitalize on early success. BioCork’s aggressive planning was a major contributor to the project’s overall success.

BioCork’s master schedule was unique in that it included owner activities to the same level of detail compared to more traditional engineering and construction activities. Progress against each area of the master schedule was reviewed weekly and the entire schedule was updated monthly. In order to capitalize on good progress, early dates were planned and then the schedule was adjusted if they had not been met.

BioCork’s budget also tracked all aspects of the project in great detail. Due to the “open book” style of contracting, the

*Concludes on page 16.*

## John Sisk & Son Ltd.

are delighted to have delivered the construction and commissioning on **Centocor Biologics** and congratulate all the team on the success of winning **FOYA - Sustainability**.

Sisk Pharma have served the industry for 40 years with over €1 billion in projects since 2000 alone.



CELEBRATING  
**150**  
YEARS



Visit [www.sisk.ie](http://www.sisk.ie) for further information

owner had access to the details of the engineer's and contractor's expenditures on a continuous basis. This minimized surprises for expenditures that slipped between the cracks.

## Safety First

BioCork is one of the safest large projects ever built in Ireland. The BioCork's team credits this to careful preparation, communication, and implementation of safety planning.

A tiered safety management system was in place for the duration of the project. Each contract company had a safety officer. The main contractor had a Project Safety Team that managed all the day-to-day aspects of project safety. The client safety personnel then reviewed overall project safety systems and outcomes.

All those working on site were required to complete site specific safety induction training and one-day off-site FAS Safe Training (National Construction Safety Training). Owner personnel visiting the site were held to the same standards as contractor personnel.

The contractor conducted regular toolbox talks (safety briefings) and multiple daily internal audits while the client conducted weekly safety audits. An external consultant conducted bi-weekly safety audits. Each audit produced action items and work was stopped if action items were not addressed in a timely fashion. Safety metrics for each contractor/sub contractor were measured and published on a monthly basis and improvement plans were developed for contractors scoring below a set limit. Overall accident free hours were set, and when achieved, the site was closed early and a celebration with prizes held.

As a result of these efforts and the cooperation of those working on the site, the following results were achieved:

### Key Project Participants

**Architect/Engineer:** The PM Group, Blackrock, Cork, Ireland  
(See ad on page 11)

**Designer/Architect/Engineer:** CRB Consulting Engineers, Inc.,  
Plymouth Meeting, Pennsylvania, USA  
(See ad on page 11)

**Construction and Main/General Manager:** John Sisk and Son  
Ltd., Capwell Works, Cork, Ireland (See ad on page 15)

**Piping Subcontractor:** Mercury Engineering, Foxrock, Dublin  
18, Ireland

**HVAC Subcontractor:** Rockwell Construction Ltd., Cork, Ireland

**Automation and Control Supplier:** ProsCon, Cork, Ireland  
(See ad on page 13)

#### Major Equipment Suppliers:

- Emerson Process Management Ltd., Cheshire, UK
- Fedegari Autoclavi SpA, Albzzano (PV), Italy
- Flow Technology Ltd., Cork, Ireland
- GE Healthcare UK Ltd., Bucks, UK
- Getinge-La Calhene, Cambridge, UK
- Gilroy Automation Ltd., Cork, Ireland
- Kells Stainless Ltd., County Meath, Ireland

(See ad on page 14)

- SkidTeck Ltd., Cork, Ireland
- Schneider Electric Ireland, County Kidare, Ireland
- Techniserv Inc., Berwick, Pennsylvania, USA
- York International Ltd., Essex, UK



Walkable ceilings minimize traffic in cleanrooms.

- With more than 4,000 contract personnel involved in the construction of the facility over a two and a half year period and with more than 830 people on site at peak, 1,052,997 consecutive hours were worked without injury and only five lost workday cases were experienced over a total of 2,865,012 hours worked with no serious injuries.
- The Lost Time Incident Rate (LTIR) = 0.35 (industry average for 2005 was 2.2).
- Received National Irish Safety Organization award for construction safety.

## Conclusion

Centocor Biologics Ireland went to extraordinary lengths to ensure that its BioCork facility in County Cork met or exceeded standards for energy-efficiency and sustainability with the utilization of a biomass boiler, an advanced membrane waste water treatment facility, recycled rainwater capabilities, and extensive landscaping that mitigated the visual impact of such a large facility in a largely residential area. Not only is the facility 40% more energy-efficient than internal benchmarks, but it was also one of the safest large projects ever built in Ireland. 

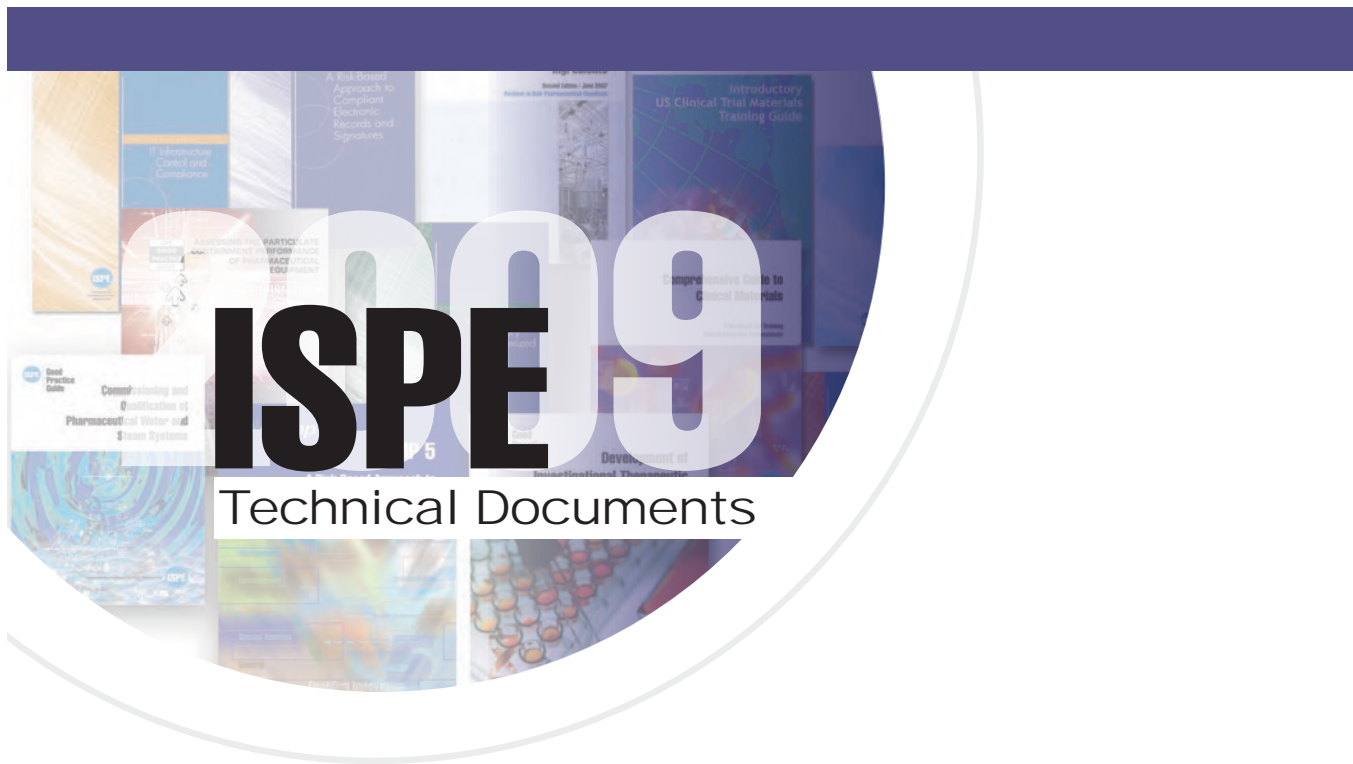

## Stay on the Cutting Edge with ISPE Technical Documents and Publications

ISPE offers the tools and resources necessary to keep you up-to-date with industry changes, while keeping your production costs low.



Reflecting current regulatory expectations and good practices, the *GAMP*® 5 Guide and *GAMP*® Good Practice Guide series help narrow the interpretation of regulatory standards for improved compliance, quality, efficiency, and cost reductions.



*ISPE Good Practice Guides* (GPGs) provide information on a particular topic area while explaining underlying technical principles and suggest multiple solutions where several outcomes may be possible.



ISPE's *Baseline*® *Guides* offer practical answers to challenges facing facility designers while providing an understanding of products and processes.



GMP products and publications make good business sense and help meet regulatory requirements.

Electronic licenses are now available.  
Contact Gloria Hall at [ghall@ispe.org](mailto:ghall@ispe.org) for more information.

ENGINEERING PHARMACEUTICAL INNOVATION



For more information on these or other ISPE technical documents and publications, visit [www.ISPE.org/publications](http://www.ISPE.org/publications) today!



# Centocor R&D Schaffhausen

## Superior Integration Shortens Bridge from R&D to Commercial

### Introduction

**R**ecognizing the need for more capacity and capabilities in their existing fill finish facility to meet the future needs of its expanding product pipeline, Centocor Research and Development built the **F2P2 R&D Fill Finish Hub**.

This new fill finish pilot plant facility, located on Centocor's Schaffhausen, Switzerland campus, is the winner of the **2009 Facility of the Year Award (FOYA) for Facility Integration**. The plant demonstrates excellence in integration with existing facilities on campus and exceptional integration of facility and equipment designs, all contributing to an efficient and flexible operation.

### Mission: Ease Process Comparability and Scale-Up

Centocor Inc., a subsidiary of Johnson and Johnson, is a leader in monoclonal antibody production and technology, using research and biomanufacturing to deliver biomedicines for immunological and oncological disorders. The company has created therapies for the treatment of people suffering from gastroenterologic, rheumatologic, and dermatologic diseases and brought drugs to market that effectively treat Crohn's disease, rheumatoid arthritis, ankylosing spondylitis, psoriatic arthritis, ulcerative colitis, and psoriasis.

In Schaffhausen, Centocor R&D is a division of Cilag AG and is responsible for fill finish operations and analytical testing of clinical supplies for technology transfer activities and for marketed product support to commercial plants.

The new 670 sq. m. R&D fill finish plant produces biological drug product for early- and late-stage clinical trials and also plays a key role in the transfer of fill finish operations into a commercial plant, also located on the Schaffhausen campus. With its capability for compounding and final formulation, vial and syringe filling, and lyophilization, F2P2 is a highly integrated facility that provides flexibility for new product development

### Centocor R&D Schaffhausen

Category Winner – Facility Integration

**Project:** F2P2 R&D Fill Finish Hub

**Location:** Schaffhausen, Switzerland

**Size:** 7,219 sq. ft. (670 sq. m.)

**Total Project Cost:** \$24.9 million

**Duration of Construction:** 21 months



View of the CIP/SIP compounding work stations.

and clinical manufacturing, as well as an efficient operational platform. The plant offers a state-of-the-art technology portfolio that mirrors the set-up of commercial facilities to ease process comparability and scale-up.

### Campus Integration

Although challenging to design, the facility was built in a way that maximizes interactions with other key groups such as Quality Assurance (QA), Quality Control (QC), and commercial manufacturing.

The facility had to be integrated into an existing building and connected to the facility entry to the adjacent QC building. Additionally, the facility shell had to be expandable to three additional floors that were level with the production floors of the adjacent Commercial building, which houses parenteral manufacturing.

Centocor considered this condensed arrangement the most feasible way to segregate R&D and commercial plants, while benefiting from synergies in campus infrastructure and from key support functions located in the QC building, such as QA QC labs and R&D offices.

Based on these requirements, the available space to integrate the entire production facility as well as the required building services was limited to 670 sq. m. with a clearance height of only 4.10 m. Another 300 sq. m. of technical area to be shared with operations were available in the basement of the building.

### Integration of Facility and Equipment Designs

The new facility provides three cleanrooms: two Restricted

*Continued on page 20.*



**METALL+PLASTIC**  
Cleanroom Technology

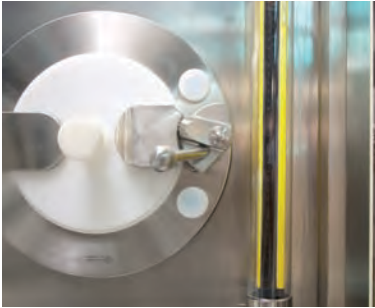

## Congratulations to centocor

We are proud to have been part of your team.  
It was great working with you.



METALL+PLASTIC is a global leader in the design, manufacture, installation and validation of Isolators, E-Beam Tunnels, VHP® Transfer Chambers and Gastight Doors.



### Germany

METALL+PLASTIC GmbH  
Bodmaner Straße 2  
78315 Radolfzell-Stahringen  
Phone +49 (0) 77 38-92 80-0  
e-mail info@metall-plastic.de

[www.metall-plastic.de](http://www.metall-plastic.de)

### USA

METALL+PLASTIC INC.  
1222 West Golf Road  
Libertyville, IL 60048  
Phone +1-847-247 1112  
Mobile +1-847-219 5443  
e-mail j.vogel@metall-plastic.de

## Notes from the Judging Panel – What Impressed Them

*Integration was exceptional with existing facility. They are doing some innovative things with process control. Expanding floors for future growth was a plus. It was a challenging work site. There were noise restrictions because of the residential area nearby. This is a nice solid project in a tricky area.*

Access Barrier Systems (RABS)-based cleanrooms and one classical cleanroom, the latter designed for manual filling or manufacturing/assembly processes of combination products.

Room layouts were designed to maximize use of space. A common support area services both vial and syringe suites. Each filling suite can be isolated from the other areas by means of hermetically sealed doors and dedicated HVAC units, thereby permitting concurrent operations.

Since there were space limitations for material storage, a new concept of a rotating multi-shelf storage cabinet was introduced. This simplifies logistics and material storage in a controlled environment and is a central part of the material preparation area.



Facility mockup study. The layout details are drawn on a cover laid over top the finished epoxy floor.

A Vaporized Hydrogen Peroxide (VHP) pass-through chamber was built as an integrated part of the cleanrooms to connect the material preparation area with a B-grade corridor. This feature supports the transfer of heat sensitive, decontaminated material and equipment into the aseptic core. The VHP chamber is equipped with airtight doors on both sides. The chamber has  $H_2O_2$  sensors for personnel protection. A short decontamination cycle time (qualified for a 6 log bioburden reduction) of no more than two hours supports a fast changeover.

Process comparability between R&D and commercial was one of the key design criteria for incorporating stainless steel

## Innovations made by HOF

HOF Sonderanlagenbau  
Your Supplier of GMP Freeze Drying Units  
and Loading/Unloading Systems



Please visit us:

**ACHEMA 2009**

Frankfurt/Main, Germany  
11<sup>th</sup> - 15<sup>th</sup> May 2009  
Hall 4.1, Stand N5-N7

HOF Sonderanlagenbau GmbH  
Ludwig-Rinn-Straße 1-3  
D-35102 Lohra  
Tel (+49) - (0) 64 62-60 80  
Fax (+49) - (0) 64 62-12 86  
[www.HOF-Sonderanlagen.de](http://www.HOF-Sonderanlagen.de)

compounding and filtration tanks. As a result, the pooling, compounding, and filtration equipment had to be designed to account for batch volumes covering a range of 1-65 L. A multipurpose, flexible concept based on modular components was chosen for the filling lines.

The vial filling line is a customized, multi-format equipment which allows the processing of a broad spectrum of vial sizes, including standard glass components as well as pre-sterilized vial formats based on cyclo-olefine polymers. A continuous manufacturing process based on inline washing, depyrogenation, filling, and capping was incorporated to permit an efficient operation. Filling technology was designed for rotary piston pumps as well as peristaltic pumps to account for shear sensitive formulations. A scale ratio of factor three to four from lab (0.6 sq. m.) to pilot and to commercial (25 sq. m.) provides good comparability and reproducibility of lyophilization cycle performance. Capping is designed to occur under aseptic conditions, as proposed under EMEA regulations.

A unique hybrid concept was chosen for the syringe filling line to allow maximum flexibility for syringe processing. The bulk syringe line serves as the backbone of this hybrid system and is fitted with several mobile modules to process pre-siliconized, pre-sterilized Ready-to-Fill (RtF) syringes in tubs. This unique approach allows development of baked-on siliconization technology for bulk syringes, while other syringe formats or materials (plastic, pre-coated) can be processed on the same line via the RtF extension. After filling, the syringes are collected on a

## Why Our Project Should Win

The following is an excerpt from Centocor R&D Schaffhausen's submission, stating, in their own words, the top reasons why their project should win the 2009 Facility of the Year Award:

- Creating a unique solution for a multiproduct, multi-format R&D clinical fill finish facility well integrated into an existing campus and has the possibility for expansion by adding floors above the existing structure
- Demonstrating superior integration of facility and equipment designs that provide maximum flexibility with high levels of sterility assurance (RABS and VHP decontamination concept) and an efficient operation
- Demonstrating the use of several important design methodologies, such as air flow simulations, facility mockups for equipment, layout, and process FMEAs
- Demonstrating innovative design of vial and syringe equipment that offers multiple format options for greater flexibility
- Providing a high level of equipment and process comparability for a lean scale-up and technology transfer process between R&D and commercial operations

*Continued on page 22.*

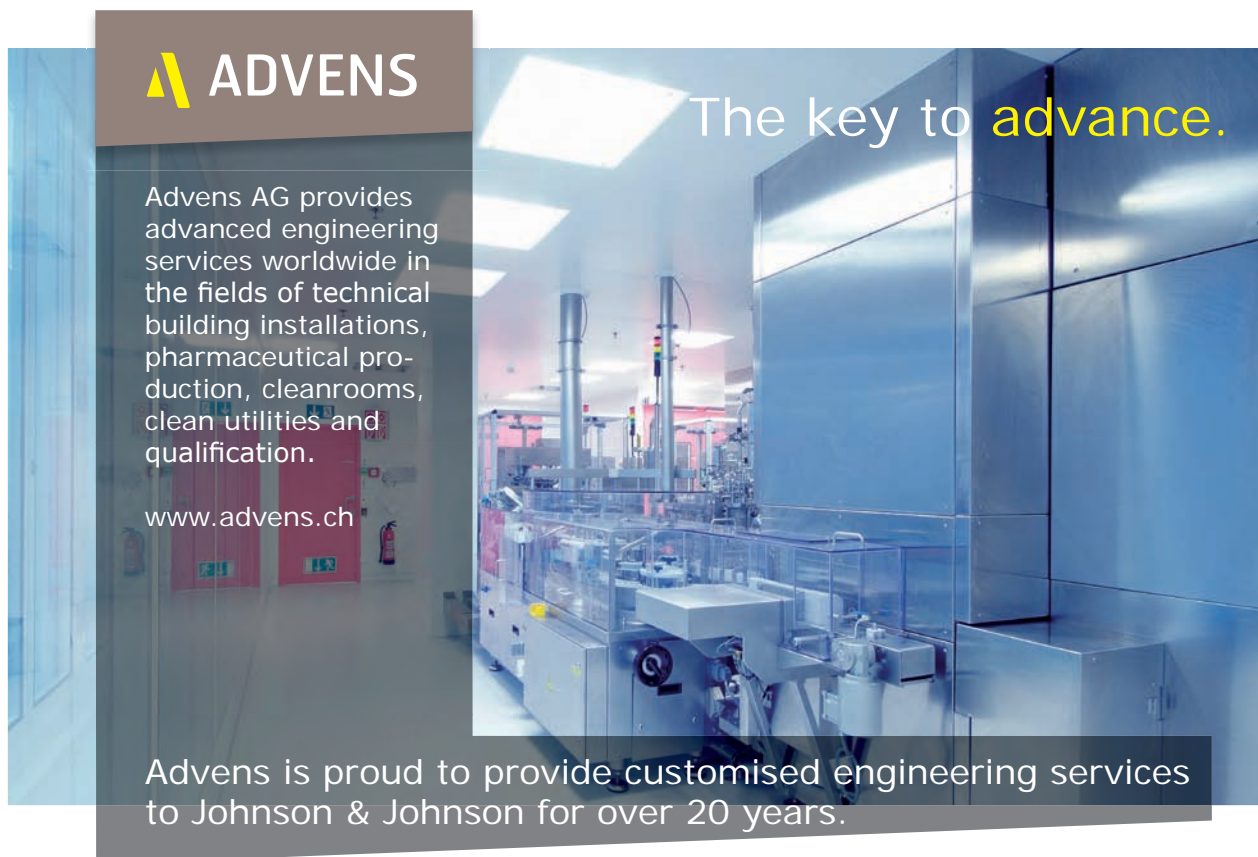

**ADVENS**

Advens AG provides advanced engineering services worldwide in the fields of technical building installations, pharmaceutical production, cleanrooms, clean utilities and qualification.

[www.advens.ch](http://www.advens.ch)

The key to **advance.**

Advens is proud to provide customised engineering services to Johnson & Johnson for over 20 years.

re-trayer equipped with empty trays. Another special flexibility feature of this hybrid syringe line allows for a mobile cartridge filler to be connected to the depyrogenation tunnel outlet.

Both filling lines are equipped with two filling stations and nitrogen overlay features. Current technical filling capacity is at approximately 4,000 units/hour for the largest format (30 ml) to be processed.

## Innovation in Process Controls

Process excellence tools were applied during the initial design of the facility to analyze and streamline the production process. This analysis in the early design phase had a major impact on the specification of the equipment. As a result, process steps on the time-critical path could be identified and optimized by introducing automated process steps. For example, a process simulation revealed

that the substitution of the manual disinfection process by a fully automated VHP-cleanroom decontamination is a clear benefit to the overall batch processing time.

A number of features enable the facility to be run efficiently and with a limited staff. Automation of process equipment, data acquisition, and documentation retrieval all contribute to this. A single automation architecture for all process equipment and utilities simplifies running the various systems. Automated data collection is used. For example, facility environment sensors are networked to a central server, allowing for real-time data collection from cleanrooms and data access from the office areas. A plant historian system enables data sharing throughout Centocor's worldwide enterprise. SOPs and technical documentation for equipment handling are accessible



## SOARING TO ATTAIN YOUR GOALS

Optima Group pharma wishes to extend our heartfelt congratulations to Centocor on achieving this Facility of the Year award. It goes without saying that an enormous amount of dedication, fortitude, and vision were put forth by everyone involved in making this facility happen. Again, congratulations on a job well done.



OPTIMA GROUP  
pharma

*We care for people*

OPTIMA packaging group GmbH Steinbeisweg 20  
74523 Schwäbisch Hall Germany www.optima-group.de  
OPTIMA Machinery Corporation 1330 Contract Drive  
Green Bay, WI 54304 www.optima-usa.com



Cleanroom operator opening the cabinet containing sterilized frames for the freeze dryer.

*Concludes on page 24.*

2009

# ISPE

Conferences, Webinars,  
and Classroom Training  
Worldwide

Watch ISPE.org for details.

**Brussels Conference on Enhanced Competitiveness - Sustainable Achievements**

30 March-2 April 2009, Brussels, Belgium

HVAC: Good Practice and Innovations, *GAMP*<sup>®</sup> 5, 21 CFR Part 11 and the EU GMP Annex 11, critical utilities, continuous process and process intensification, manufacturing excellence and R&D laboratories, and containment and calibration training courses

**India Affiliate Meeting Featuring PQLI<sup>®</sup>**

13-14 April 2009, Mumbai, India

**Japan Affiliate Annual Meeting Including PQLI<sup>®</sup>**

16-17 April 2009, Tokyo, Japan

Held in Funabari, Tokyo.

**Washington Conference: Engineering Regulatory Compliance**

1-4 June 2009, Washington, D.C., USA

PQLI, barrier isolation technology, packaging challenges, *GAMP* Good Practice Guides on VPCS Ver. 2 and Calibration Management Ver. 2, C&Q, global supply chain security and anticounterfeiting, applied risk management, renovation project challenges, and training courses on *GAMP* 5 and GMPs

**Strasbourg Conference: Quality - Knowledge Through Science**

28 September-1 October 2009, Strasbourg, France

Barrier isolation innovation updates and new case studies, investigational products, *GAMP* 5 operational aspects, containment, disposables, PQLI, and C&Q

**Live Webinar: *GAMP* Hot Topic Series *GAMP* 5 Approach to Compliant End-user Applications**

25 March, 11.00 EDT, 09.00 PDT, 16.00 GMT, 17.00 CET

End-user systems, risks related to end-user systems, risk management approach, and approaches to compliance

**Chicago Classroom Training**

11-14 May 2009, Chicago, Illinois, USA

*GAMP* 5, water, HVAC, biotechnology, C&Q, Q7a, and technology transfer for finished dosage forms

**Madrid Classroom Training**

18-21 May 2009, Madrid, Spain

*GAMP* 5, water, technology transfer for API, HVAC, C&Q, and PAT

**Philadelphia Classroom Training**

5-8 October 2009, Philadelphia, Pennsylvania, USA

HVAC, *GAMP* 5, sterile products, water, C&Q, oral solid dosage, and clinical materials

**Dublin Classroom Training**

Fall 2009, Dublin, Ireland

Water, *GAMP* 5, Q7A, basic C&Q, biopharmaceutical manufacturing processes, and PAT

**ISPE 2009 Annual Meeting**

8-11 November 2009 • San Diego, California, USA

Eleven session tracks: product development, facilities and equipment, information systems, supply chain management, production systems, regulatory compliance, quality systems, project management, investigational products, suppliers, and survival-focused.

**Sponsorship and Exhibit Opportunities Available**

ENGINEERING PHARMACEUTICAL INNOVATION



## Key Project Participants

**Architect:** PMB Bau AG, Schaffhausen, Switzerland

**Designers/Architects/Engineers:**

- Advens AG (Bickel & Bachofen AG), Winterthur, Switzerland *(See ad on page 21)*
- NNE Pharmaplan, Bad Homburg, Germany *(See ad on page 25)*

**Construction Manager:** Danny van Dyck, Beerse, Belgium

**Piping Subcontractor:** Zeta AG, Wangen, Switzerland

**HVAC Subcontractor:** Axima AG, Winterthur, Switzerland

**Automation and Control Suppliers:**

- Etavis Installation AG, Zürich, Switzerland
- Retel Neuhausen AG, Neuhausen, Switzerland

**Major Equipment Suppliers:**

- Belimed AG, Ballwil, Switzerland
- HOF Sonderanlagenbau GmbH, Lohra, Germany *(See ad on page 20)*
- Optima Group Pharma, Schwäbisch Hall, Germany *(See ad on page 22)*
- Metall + Plastic GmbH, Radolfzell, Germany *(See ad on page 19)*

online via operator panels in the cleanrooms.

The F2P2 is supported by a state-of-the-art analytical laboratory for both routine operations as well as a particulate analysis laboratory, which contains equipment for microanalysis using methods based on infrared, X-ray, and mass spectroscopy. In collaboration with the particulate analysis lab, a facility specific particulate database was developed. All materials used during construction, qualification, and validation of the facility, as well as material used for the daily operations (e.g., gowning material, agents for sanitization and disinfection) were characterized and entered into an analytical database to trace back foreign matter identified during visual inspection of drug product. During manufacturing, the fill finish process in F2P2 is monitored by means of turbidity and Microflow Digital Imaging (MDI) measurement.

## Conclusion

Through superior integration, the F2P2 efficiently bridges development to commercial operations. Using the facility,



Glove ports for the syringe line that is integrated into the cleanroom wall; human machine interface (HMI) displays process and environmental data for operators inside the cleanroom.

Centocor representatives said their staff has demonstrated on-time delivery of clinical supplies in more than six batch runs. In addition, a high level of comparability between R&D and commercial fill finish process, equipment, and scale have facilitated technology transfer and scalability from pilot to commercial scale. The facility has allowed Centocor to expand its new product pipeline and to bring new drug candidates quickly into clinical trials. 



View from the visitor corridor of the washer and depyrogenation tunnel located in the C-grade area.

# more than engineering

...leads to **exceptional** facilities

Client: **Centocor Research & Development**  
Where: **Schaffhausen, Switzerland**  
When: **October 2004 – March 2008**  
What: **New R&D fill finish pilot plant**  
Service: **Layout Development, Process/Equipment Design  
and Installation/Commissioning Management**  
**2009 Facility of the Year Award Winner**  
**– Facility Integration**



Client: **Hameln Pharma**  
Where: **Hameln, Germany**  
When: **March 2006 – April 2008**  
What: **New sterile production plant**  
Service: **Review and rework of Conceptual Design, Basic  
Design, Process Engineering and Qualification**  
**2009 Facility of the Year Award Winner**  
**– Operational Excellence**



Client: **Novo Nordisk A/S**  
Where: **Hillerød, Denmark**  
When: **May 2001 – November 2002**  
What: **Facility for the life saving drug NovoSeven®**  
Service: **Design and construction. Finished in 18 months by  
use of modular engineering**  
**2005 Facility of the Year Award Winner**



NNE Pharmaplan is the world's leading engineering and consulting company focused exclusively on the pharma and biotech industries. NNE Pharmaplan employs more than 1500 people at over 20 locations around the world.

nne pharmaplan®

[nnepharmaplan.com](http://nnepharmaplan.com)



## hameln pharma

# Every Step Counts Toward Operational Excellence

### Introduction

Three years ago, hameln pharma embarked on a mission to build a factory that would significantly increase their production capacity in the area of parenteral contract manufacturing, create expansion possibilities for their company, and ensure reliable compliance with international regulatory standards.

This category winner successfully completed their mission with the construction of the **New Sterile Facility** in Hamelin, Germany. Winner of the **2009 Facility of the Year Award for Operational Excellence**, the facility was tailor-designed and constructed by Koppenhöfer + Partner GmbH to maximize the efficiency of every step of the sterile production process.

### A Family of Experts in Parenteral Medicines

Experts in parenteral medicines, hameln pharma is part of the hameln group, a family-owned and -operated group of companies whose core business has been the development, production, and distribution of pharmaceuticals with a focus on parenteral medicines for more than 50 years.

The company specializes in the contract manufacturing of parenteral medicines predominately used in hospitals and intensive care in more than 70 markets worldwide. The company has more than 350 employees skilled and experienced in dealing with products, such as narcotics, suspensions, and oily solutions – from the initial weighing for preparation and filling, up through the packaging of 1 mL to 50 mL ampoules or 2 mL to 250 mL vials.

In an existing facility located at hameln group's headquarters in Hamelin, Germany, the staff of hameln pharma currently processes about 350 products on the bulk products level, aseptic or terminally sterilized. The new 9,200 sq. m. sterile production plant integrates all process steps required for the production and filling of parenteral products, while the subsequent processes of visual inspection through final packaging remain in the existing building.

### hameln pharma

Category Winner – Operational Excellence

**Project:** New Sterile Facility

**Location:** Hamelin, Germany

**Size:** 99,028 sq. ft. (9,200 sq. m.)

**Total Project Cost:** \$44.5 million

**Duration of Construction:** 13 months



Setting the machines up in a u-shape reduces the space required in the highest cleanroom class and increases the employees' productivity.

### As Lean as Can Be

Lean production concepts were consistently implemented throughout the design and construction of the new facility.

The work areas within the sterile production plant were arranged using a materials flow simulation to prevent any form of waste of capacities, personnel, and materials movement, resources, area, or time. These simulations provided the construction prerequisites for an optimized, efficient process, which is demonstrated in the facility's ratio of 63% effective area to gross area. With the aid of integrated locks and hatches, materials are always transferred by the shortest route from one production step to the next.

The arrangement of the cleanroom classes to each other and a consistent lock design ensure that employees only need to cover short distances and go through as few clothing changes



Material locks in the wall ensure short ways for the transfer of samples and documentation to the analytical department.

as possible, saving time and improving safety significantly. The consistent standardization of rooms, equipment, inventory, production resources, and processes increases employee productivity as well as the efficiency of the entire production process since employees are able to continuously orient themselves and work in a quick and organized manner.

Lean production principles also were implemented in the arrangement of the filling systems. The U-shaped structure of the systems reduces the footprint in the highest cleanroom class and increases productivity. Both the loading of glass containers and the removal of the filled and sealed ampoules and vials are done in a Class D room by one and the same employee, who does not have to move between different cleanrooms. The complete monitoring of the actual filling process is done by another employee who remains in the neighboring Class B cleanroom. Less movement in the cleanroom means reduced risk of contamination.

A pharmaceutical cleanroom ceiling that is 100% accessible – meaning that it can be walked on everywhere – allows the exchange, installation, and maintenance of basic technical equipment, such as lamps and filter units, from above the ceiling, keeping production undisturbed. The arrangement of the cleanrooms to each other and separate corridors with integrated maintenance doors and segmented ventilation circuits allows maintenance and repairs to also be carried out on individual filling lines without interrupting production.

### Annex 1 Compliant

According to Annex 1, continuous particulate monitoring compliant with standards for cleanroom classes A and B was installed during construction. Airborne germ measurements at critical points in the Class A area are also monitored by an automated system. With the remodeling of Annex 1, the capping for all vial lines will be done in cleanroom Class A as an aseptic process with sterilized caps, physically separated from stoppering and filling.

### Managing Operations with 5-S

Short routes, reduced intermediate storage, and optimized materials flow reflect

## Notes from the Judging Panel – What Impressed Them

*The process that this company goes through to make sterile products, how they do their business, and how all elements fit together from the corporate, employee, operational, etc., standpoints, and the tying of everything together is exceptional. The project cites being up to date on all new Annex 1 regulations. The pricing is fairly low for what they built. This facility has taken so many processes and tied them together.*

Continued on page 28.

hameln  
pharma



### We don't talk about Operational Excellence – we live it!

With the know-how of a specialist and state-of-the-art technology we have built a highly innovative, flexible and efficient sterile production facility:

- tailored to the actual production process
- according to the lean manufacturing model
- maximum efficiency and high quality
- measurable benefit for our customers



hameln pharmaceuticals gmbh  
Langes Feld 13  
31789 Hameln, Germany

[www.hameln-pharma.com](http://www.hameln-pharma.com)

Responsible Flexible Reliable

## Key Project Participants

**Project Director:** Dr. Simone Dahlmanns, hameln pharmaceuticals gmbh, Hamelin, Germany

**Designer/Architect/Engineer:** Peter Fischer, Koppenhöfer + Partner GmbH, Office for Industrial Planning, Stuttgart, Germany (See ad on page 28)

**Construction Manager:** Ulrich Baumann, IKB Immobilien Management, Düsseldorf, Germany

**Main/General Contractor:** Adam Abel, ARGE Pharmabau, Neckartailfingen, Germany

### HVAC Subcontractors:

- Adam Abel, Daldrop + Dr. Ing. Huber, Neckartailfingen, Germany (See ad on page 3)

- Christian Hage, IP – Innovatives Planen GmbH, Neckartailfingen, Germany

**Automation and Control Supplier:** Gerhard Neuberger, Neuberger Gebäudeautomation GmbH 7 Co. KG, Rothenburg, Germany

### Major Equipment Suppliers:

- Robert Bosch GmbH (Bosch Packaging Technology), Crailsheim, Germany (See ad on page 29)

- Belimed Deutschland GmbH, Mühlheim am Inn, Germany

- Letzner Pharmawasseraufbereitung GmbH, Hückeswagen, Germany (See ad on page 31)

- Pharmatec GmbH, Dresden, Germany

- NNE Pharmaplan, Bad Homburg, Germany (See ad on page 25)

- Carpus Prozess Experten GmbH, Hattersheim, Germany

the entire production layout. To take that a step further, on the operational level, the 5-S method is used to improve overall processing times. This management method consists of:

- Separate and Scrap
- Straighten
- Scrub
- Standardize and Spread
- Systemize

For hameln pharma, the 5-S method ensures safe, clean workstations; avoids time wasted searching for resources and work equipment; allows for the early and timely detection of defects and maintenance requirements, avoiding downtime; reduces the cleaning effort; and improves ergonomics in the workplace.

With the assignment and concentration of individual products on suitable production lines, the complete product pass, from start through filling and finally to packaging, is performed in a flow of movement leading to an optimal utilization of capacities at maximum productivity.

A system of coordinated equipment, transportation, and storage activities for the cleaning and sterilization of format parts ensures a cyclical process that avoids any type of waste. During the entire cleaning process, the format parts remain on one and the same cart on which they occupy the ideal and always identical position depending on their subsequent use. The format parts carts have the dimensions they need to be able

*Concludes on page 30.*



**Koppenhöfer + Partner GmbH is your reliable partner for the industrial branches**

- PHARMA, BIOTECHNOLOGY, COSMETICS
- RESEARCH + DEVELOPMENT
- AUTOMOBILE
- SEMICONDUCTOR
- LOGISTICS

**Our experience-resulting from more than 350 planned and completed industrial projects worldwide as well as synergies of different industries guarantee reliability in**

- PROGRAMMING, FEASIBILITY STUDIES
- CONCEPTUAL DESIGN
- PROJECT DEVELOPMENT, PROCESS LAYOUT
- ARCHITECTURAL DESIGN
- PROJECT MANAGEMENT
- COST AND PROGRESS CONTROL
- CONSTRUCTION MANAGEMENT AND SUPERVISION
- QUALITY CONTROL MANAGEMENT
- HEALTH AND SAFETY COORDINATION (HSC)
- VALIDATION, QUALIFICATION
- GENERAL PLANNING

**KOPPENHÖFER + PARTNER GmbH**  
Architects Engineers General Planners  
Office for Industrial Plant Design



Category: **Operational Excellence**  
Client: **hameln pharma GmbH, Hameln**  
Project: **New Sterile Production**  
KOP Services: Rework, Redesign, Concept, Basic Design, Layout, Detail Design

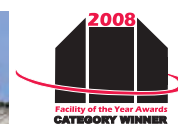

Category: **Execution Excellence**  
Client: **Roche Diagnostics GmbH, Penzberg**  
Project: **Biologics IV**  
KOP Services: General Planner Building Design and Building Services Engineering



Categories: **Process Innovation/Overall Winner**  
Client: **Pfizer Manufacturing, Illertissen**  
Project: **NewCon**  
KOP Services: Design Interior Works, Concept to Detail Design, CM Building, Landscaping

Sigmaringer Str. 121, D-70567 Stuttgart  
Phone: +49 711/7190-0, Fax: +49 711/7190-199  
E-Mail: kop@kop.de, Web: www.kop.de

**77** years of experience  
in industrial plant design  
**KOPPENHÖFER + PARTNER GmbH**



# Bosch. Nested syringe filling like you have never seen before.

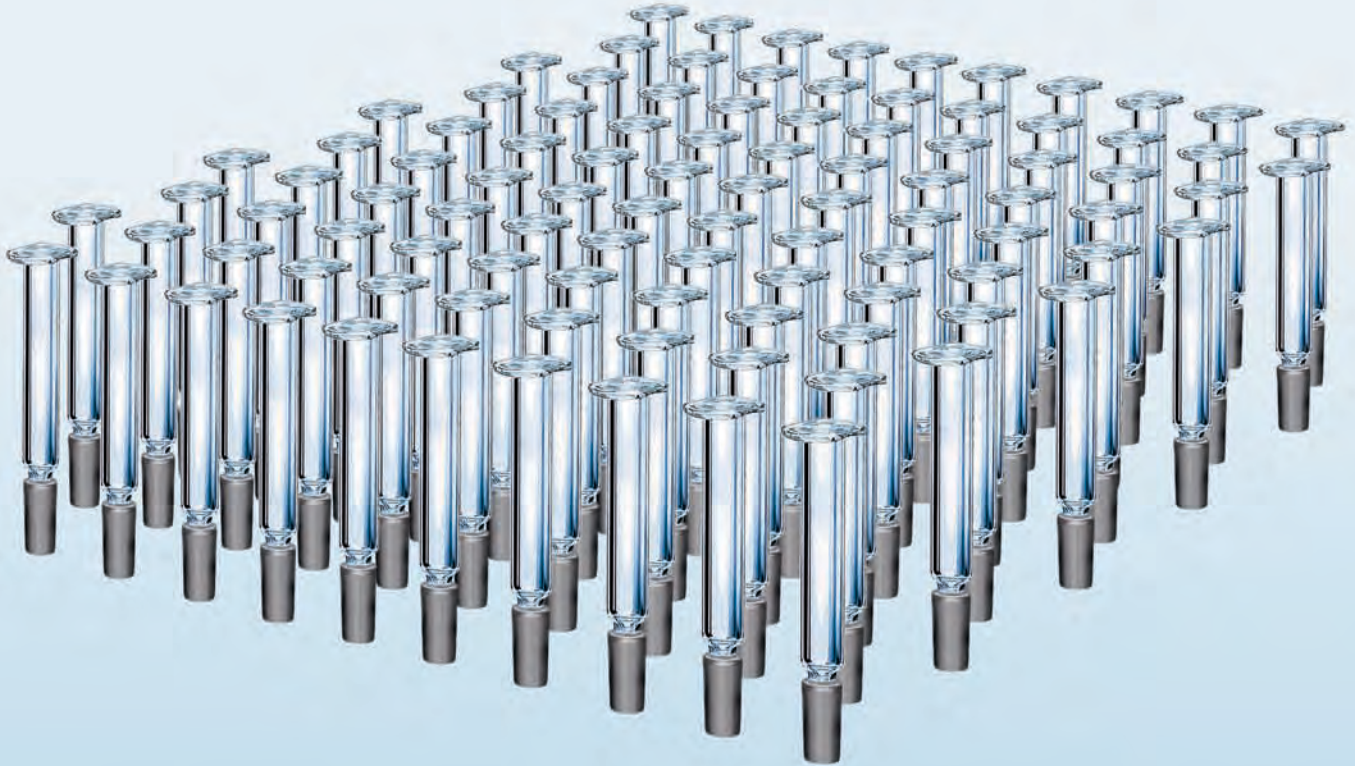

**ACHEMA** 11 - 15 May  
2009  
Visit us in hall 3.1 at booth F2-J11  
Messe Frankfurt, Frankfurt am Main, Germany  
We look forward to seeing you!

**Bosch is well known for filling and packaging** of vials, ampoules, cartridges and bulk syringes. It is with this extensive knowledge and experience that Bosch now introduces a new product line designed specifically for nested syringes. With quality and innovation in mind, Bosch is introducing a complete portfolio of nested syringe filling and packaging equipment. You can expect all of the same great quality, efficiency, high performance and support as Bosch offers with its other equipment.



**BOSCH**  
Invented for life

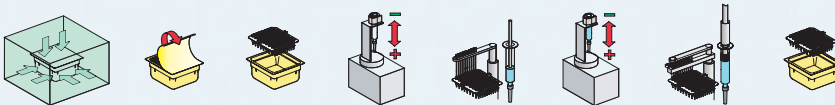

**Robert Bosch GmbH**  
Pharma Liquid  
Phone: +49 79 51 40 21 | Fax: +49 79 51 40 22 58  
packaging@bosch.com | www.boschpackaging.com

## Why Our Project Should Win

The following is an excerpt from hameln pharma's submission, stating, in their own words, the top reasons why their project should win the 2009 Facility of the Year Award:

- Form follows function – a facility that perfectly combines functionality and aesthetics, offering conditions that promote both efficiency and well-being, while still remaining flexible enough to react to varied requirements was the vision and governing principle of the tailor-made layout of this multipurpose building. The entire cleanroom concept, the configurations of the filling lines and the processes themselves have been designed and implemented to support functionality. This also facilitates the handling of a broad variety of container formats, batch sizes, potencies, formulations, and product types. Suitable areas for a growing number of potent APIs were built which allow their handling without risk of cross-contamination or health risk to staff.
- Operational excellence – from the facility layout and process design to the start of production, the project included all the aspects necessary for supporting modern, lean production. Reduced interim storage and optimized material and personnel flow along short paths characterize the entire production layout. The set-up of the work areas follows the logical structure of the process itself, and all equipment is installed in such a way that it supports an efficient process run. Process-

es were simulated in advance to ensure a set-up which allows standardized movements to increase efficiency and speed and reduce the risk of interference.

- Upgrade to existing technology – critical processes such as the cleaning and sterilization of equipment, such as product containers, were automated by implementing systems able to control processes fully automatically without any of the involved equipment being automatic. This reduces the staff time required for cleaning and sterilization tasks significantly and increases the reliability of the production processes.
- Unique solution virtually eliminates regulatory impact on product transfer from the existing facility to the new one – a consistent risk-based approach according to ISPE and ICH guidelines was applied for the qualification and validation concept as a winning, low-cost strategy. This reduced the cost for all qualification and validation activities to a mere 6% of the total investment. The overall strategy of defining a “best case scenario” helped to nearly eliminate all regulatory impact thus, the cost for any potential product transfer. This scenario was supported by successfully reasoning that the new facility is “the same facility” and by proving that the new environment, utilities, equipment, and processes have no negative impact on either product quality or stability. This strategy was accepted by the health authorities and by more than 90% of all customers, which meant that 95% of all products could be transferred without incurring additional work and cost.

to go into the small parts washing machine as well as the pass-through autoclaves. Once the parts are cleaned and sterilized, the entire cart, including the format parts, are reintroduced into the actual production process. At his or her work station, the employee finds the individual format parts in the position on the cart with which he or she is familiar, and then puts them back in the same place after use so that the completely filled format parts cart is again prepared for cleaning and then the cycle can begin again. Studied processes accelerate productivity, while a standardized and efficiently organized cleaning process prevents time wasted due to searching for work equipment and then arranging and organizing it in the production process.

### Ready for the Future

To be able to operate a plant offering maximal production flexibility, hameln pharma buildings, facilities, and processes are standardized as much as possible. The building itself is a grid that can be expanded as needed on a modular and scalable basis; therefore, it was designed for future expansion in both spatial and technological terms.

To fulfill this requirement, the walls are set on four equal floor sections and are not embedded in the floor, which consists of 100% seamless pharmaceutical grade terrazzo. Wall fixtures, such as tool cabinets, are standardized and integrated flush with

the walls. The filling rooms in the facility are all constructed identically and allow a standardized and therefore secure operation, and production preparation activities also are organized as uniformly as possible to enable smooth and efficient production.

This standard solution has made the facility into an efficient, flexible, and manageable production operation while, at the same time, future products can be established in the shortest possible time, even new and innovative customer projects. This saves both the contract manufacturer and the customer significant effort and cost.

### Conclusion

The planning of this streamlined plant began in March 2006. Only 25 months later, hameln pharma was able to put a highly innovative and flexible production facility into operation. The layout of the facility is tailored to optimally support the production process, maximizing efficiency. To achieve this, all process steps were simulated in advance and defined so that each movement can be completed efficiently in a standardized manner.

With an eye on future development, the new production building is designed so that it can be flexibly adapted to future requirements and needs with regard to both space and technology. 

# Intelligent solution including: Antirouging and energy recovery !

Letzner Pharmawasseraufbereitung GmbH  
Robert-Koch-Str. 1 · D-42499 Hückeswagen · Tel: +49 (0) 21 92/83 88 3 · Fax: +49 (0) 21 92/92 17 33 · [www.letzner.de](http://www.letzner.de)

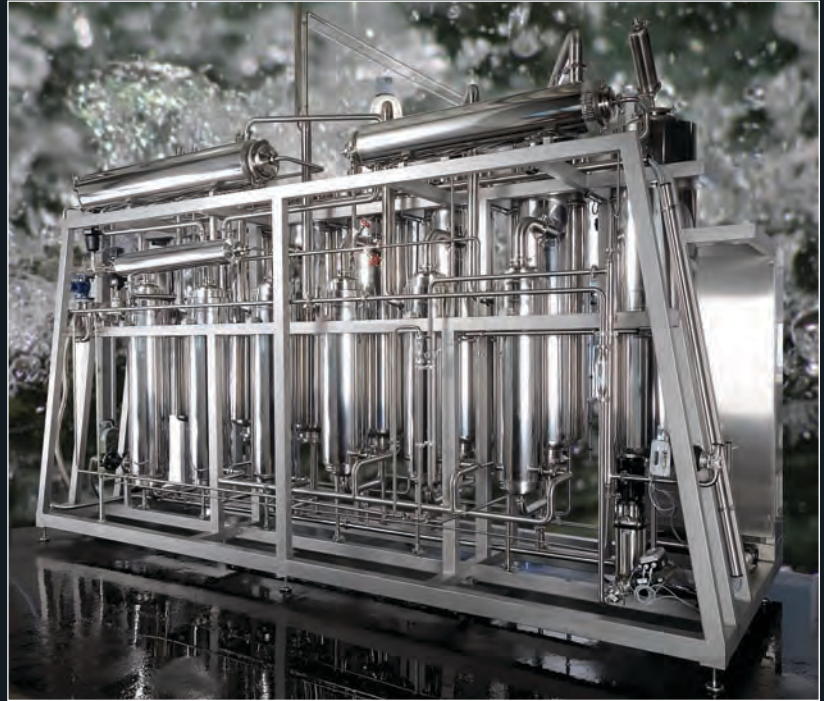

**LETZNER**  
Pharmawasseraufbereitung

# Orchid Chemicals & Pharmaceuticals

## A Model Facility for the Pharmaceutical Industry in the Region

### Introduction

**W**hen Orchid Chemicals & Pharmaceuticals constructed their new **Carbapenem Production Facility** in Aurangabad, India, they also created a facility that would serve as a beacon for others in the region.

Winner of the **2009 Facility of the Year Award for Regional Excellence**, Orchid's new facility houses one of the first cGMP operational systems for bulk API handling in India and features a high degree of automation and innovative energy conservation measures – concepts that contribute to their goal to produce quality products in a safe, consistent, and environmentally sound manner.

### Making Room for the Future

Based in Chennai (Madras), India, Orchid Chemicals & Pharmaceuticals Ltd. manufactures and sells APIs with a niche position in cephalosporin antibiotics. According to Orchid, they are the largest cephalosporin manufacturer and exporter from India.

To accommodate the growing number of development products and promote the application of new technologies, Orchid decided to create a new facility at their existing manufacturing site in Aurangabad, India, with modern and flexible cGMP aspects to manufacture internationally acceptable products.

A central goal of Orchid was to integrate all major intermediates and finished API product facilities with safe working areas and promote optimal communication and seamless cooperation across the relevant disciplines. They wanted an independent, safe facility with maximum flexibility for the handling of a broad diversity of product types and batch sizes. Most challenging was safeguarding all operations in a multi-product facility and avoiding cross-contamination.

Orchid's solution for this variety of requirements was to construct a new facility with relevant separate buildings. The new facility contains state-of-the-art process equipment, laboratories, cGMP facilities, and office areas. Both the building layout and

concept for technical support systems allow easy adoption to future needs and the implementation of new technologies.

### The Carbapenem Blueprint

The new facility is located in Aurangabad, India, 400 kilometers away from Mumbai, in an industrial zone where companies manufacture electronic devices, automobiles, chemicals, and pharmaceuticals.

Orchid's Aurangabad site includes three major manufacturing sections for: 1. non-penicillin non-cephalosporin APIs, 2. penicillin APIs, and 3. carbapenem APIs.

The Carbapenem Production Facility project consists of four major well-integrated production blocks, (Intermediate/API/Sterile/Hydrogenation) each with dedicated service and production areas. All critical operations are contained in cleanrooms and advanced technical systems are used in all sections of manufacturing.

The Carbapenem Production Facility is divided as explained below:

- Intermediate block – Key Starting Material (KSM) is charged here and intermediates are manufactured.
- API block – Intermediates are used in the API plant to produce non-sterile product.
- Hydrogenation block – The reactor and associated systems are designed to carry out high pressure reaction. The equipment is designed for 35 kg/cm<sup>2</sup> design pressure. The high speed agitator is designed for gas induction and is magnetically coupled with drive to avoid any leakage during high pressure reaction.

The reactor has a catalyst filtration system, sampling system, hydrogen and nitrogen gas manifold. The reactor is

### Orchid Chemicals & Pharmaceuticals

Category Winner – Regional Excellence

**Project:** Carbapenem Production Facilities

**Location:** Aurangabad, India

**Size:** 107,642 sq. ft. (10,000 sq. m.)

**Total Project Cost:** \$35.72 million

**Duration of Construction:** 14.5 months



Horizontal scrubbing system.

installed in a separate bay surrounded by a blast proof concrete wall toward the plant area and open to the atmosphere on the other side to avoid the effect of an accident. The reactor is equipped with all safety systems, such as a safety valve, rupture disc, knock out pot, instrumentation, and safety interlocks. Seven layers of safety are provided to ensure the highest level of safety for the asset, person, and product. Fire doors are also provided.

The majority of the plant is open from all sides to facilitate easy dispersion of hydrogen gas in case of any leakage and to minimize an explosion effect due to a confined area in case of an emergency. This layout also provides a better working environment for personnel.

- Sterile block – non-sterile products are taken to this facility to produce sterile APIs.
- Solvent recovery plant including tank farm
- Effluent treatment block
- Fire hydrant water tank and pumping station
- Infrastructure facilities such as utilities, transformer

## Conserving Energy and Reducing Costs

Orchid took several measures to conserve energy and reduce manufacturing costs during facility design, including the following:

### Vacuum System

The facility features a dry vacuum system instead of a conventional vacuum system to maintain a consistent level of vacuum throughout the process, enhance process safety and productivity, and to avoid the use of water resources, sustaining a clean environment. Pumps are designed with PFA coating to work with any corrosive fluid. All supportive systems, such as instrumentation/electrical/mechanical, are developed and installed in-house to improve process and environmental safety. The vacuum level is monitored constantly through the DCS, assuring almost no backflow in case of a power failure or mechanical breakdown of the system. A series of filters are provided to save the environment.

### Horizontal Scrubbing System

The facility also features horizontal scrubbing systems instead of conventional vertical scrubbing systems. The result is a reduction in electrical consumption by 30%, a reduction of load on the floor by 50%, and better efficiency of scrubbing because of an effective cross flow pattern. According to Orchid, this type of system, designed and installed by Orchid, has become a boon for the pharmaceutical industry to use such a system to handle

a huge quantity of lean gases with less investment and operating cost.

### Ultrasonic Technology for Crystallization Process

Orchid uses ultrasonic energy for the crystallization of their complex products. Ultrasonic wave is a form of energy which when applied, allows chemical reactions to take place in its presence. The ultrasound produces cavitations in the liquid, which effectively act like millions of micro

*Continued on page 34.*

An ISO 9001:2000 Certified Company

**Congratulations** to Orchid Chemicals & Pharmaceutical Ltd., Aurangabad, India, for winning the **2009 FACILITY OF THE YEAR AWARD!** For Regional Excellence.

## iCLEAN® CLEANROOM SOLUTIONS

**Fast track delivery** → **Fast track handover.**

iClean's technical expertise designs, manufactures and installs total cleanroom systems to suit specific customer requirement and validates the same to international guidelines.



**Products include a wide variety of custom engineered Cleanroom systems like:**

- Modular cleanrooms
- Cleanroom Accessories
- Lab Furniture
- Air Handling Units and HVAC systems
- Cleanroom Validation
- Turnkey projects



The above wide product range added to iClean's personalized project approach drawn from its vast pharmaceutical expertise offers all its customers a flexible cleanroom solution for their new and existing facilities.

Visit us at :  
**ACHEMA 2009**  
Frankfurt am Main-Germany 11-15 May  
Hall No. 4.1, Stand P-29



Tested and Certified for BS 476: Part 22 : 1987 for fire rating & surface spread of flame

## iCLEAN® INTEGRATED CLEANROOM TECHNOLOGIES LIMITED

Plot no.8, 1<sup>st</sup> Floor, NCL Enclave, Petbasheerabad, Hyderabad, Andhra Pradesh, India  
email : sales@icleantech.com / www.icleantech.com



stirrers, increasing the effective surface area. The cavitations produced also increase local pressure and local temperature by several hundred degrees in the vicinity of the bubble collapse. This not only reduces reaction time, but also helps carry out many reactions which normally require high temperature and pressure. Using this technology, crystallization time is reduced from 40 to 4.5 hours, and results in better product quality. Crystallization time reduction is variable based on product.

## **Secondary Steam Generation from Evaporator System**

Orchid uses an evaporation system for the treatment of high pollutant effluent generated from various processes. The secondary steam generated from the evaporation system is utilized as low

pressure steam in manufacturing areas. This has saved much thermal energy (reduced load on steam boiler, hence reduction in furnace oil consumption) and related emissions.

## **Agitated Filter Dryer**

To overcome the inability to recover the product “heel” left from using traditional filter/dryers and pan dryers, Orchid installed an agitated Nutsche Filter Dryer with a gas knife system. This innovative technique was first implemented and commissioned at Orchid’s new facility. The gas knife system includes a series of nitrogen nozzles located on one side of the S-blade agitator. Nitrogen is delivered down through the shaft and ported to the nitrogen nozzles. A specially designed rotary joint and shaft allows nitrogen to be ported to the agitator hub.

## **Why Our Project Should Win**

The following is an excerpt from Orchid Chemicals & Pharmaceuticals’ submission, stating, in their own words, the top reasons why their project should win the 2009 Facility of the Year Award:

- Building concept – being a multiproduct facility, it consists of physically well separated manufacturing blocks, each having its own dedicated service area and production area. A strategy was devised to guarantee the shortest supply and disposal routes. All critical operations are as much as possible contained in cleanrooms and advanced technical systems are used in all sections of manufacturing.
- Technical concept – HVAC units with separate technical areas for repair and maintenance allow cost effective and sustainable building operations. The degree of automation is completely high novel. The facility features operational ease, improved safety and process integrity, consistency in production through automation. Continuous monitoring of process parameters, control, and measuring of parameters produce consistent high quality products.
- Equipment innovation and systems – fully contained powder handling and processing equipments were developed and implemented. We believe this is the first cGMP operational system for bulk API handling in India. Automated SIP sterilization system for sterile process equipments were developed, implemented, and successfully validated. Agitated Nutsche Filter Dryer has gas knife provision and hydraulically operated locking arrangements. Equipment planning was done to increase productivity if required in the future, and flexibility was designed in to accommodate future needs, if any.
- Commitment toward environment and safety – human safety is a core organizational value and it is a condition of employment for each Orchidian. Orchid safety systems are strengthened by DuPont and Orchid aims to become one of the world’s safest organizations in the next two years. We have a “zero discharge facility.” This concept is a dream for many industries of our kind in India. We are treated as a role model in environmental safety by various organizations and local regulatory agencies, increasing our social responsibility and boosting our confidence to innovate new systems. All new processes underwent a risk assessment study by competent persons before commercial production.
- Energy efficient system – Orchid has always strived hard in the field of energy conservation. Several measures to conserve energy and to reduce associated costs were taken during facility design:
  - High level automation to precisely control process parameters, e.g., vacuum distillation, batch distillation, batch monitoring, automation of process equipments like the reactor, centrifuge, driers, HVAC units, utilities, etc.
  - 30% less power consumption by horizontal scrubbing system than conventional scrubbing system for the same application
  - Less power consumption by dry vacuum systems than conventional system
  - Installation of energy efficient multistage evaporator with least steam (0.1 kg/kg of effluent) and lowest power consumption
  - Installation of energy efficient water cooled refrigeration systems
  - Installation of energy efficient compact fluorescent lamps
  - Effective systems such as automated nitrogen blanketing for centrifuges, flash steam recovery, secondary steam generation from evaporator, etc., to save loss of utilities, which saves energy
  - Designing optimum sizes of cleanrooms by selecting innovated process equipments like peeler centrifuges, combination of operations in one unit, etc.
  - Providing modular supportive systems as per requirements than centralized common systems, hence utilization as per demand to save energy
  - Dedicated energy conservation team on site

## Notes from the Judging Panel – What Impressed Them

*Their timeline and safety record were very good, especially considering the location. This project was well-executed and the first to use certain technologies in India. They brought in a lot of technology in a place where it's difficult to do so. The challenges and how they overcame them are appreciated. They were able to increase their productivity all with local expertise.*

This mechanism provides an effective removal of product heel and resulting benefits, such as increase in productivity, less manual handling of sterile product, drastic reduction in leftover quantity of product.

### Nitrogen Blanketing System for Centrifuges

Orchid and their supplier together developed a nitrogen blanketing system for centrifuges. This system consists of a series of pressure reducing valves to obtain required pressure and back pressure regulated valves at vent to hold specified nitrogen inside the centrifuge basket for inertisation purposes. Pressure

### Key Project Participants

**Architect:** R.V. Dalvi & Associates, Mumbai – Maharashtra, India

**Designer/Architect/Engineer:** Projects Dept., Orchid Chemicals & Pharmaceuticals, Aurangabad, India

**Construction Manager:** Projects Dept., Orchid Chemicals & Pharmaceuticals, Aurangabad, India

**Main/General Contractor:** Hexagon Constructions, Hyderabad – Andhra Pradesh, India

**Piping Subcontractor:** Metro Engineers, Ankleshwar – Gujarat, India

#### HVAC Subcontractors:

- Aarco Engineering Projects Pvt. Ltd., Mumbai – Maharashtra, India
- M&W Zander Facility Engineering, Mumbai – Maharashtra, India

#### Automation and Control Suppliers:

- Emerson Process Management, Mumbai – Maharashtra, India
- Honeywell Automation India, Pune, India

#### Major Equipment Suppliers:

- Apurva Buildcare Technologies, Mumbai – Maharashtra, India
- Fedegari Autoclavi SpA, Albuzzano, Italy
- Gardner Denver Schopfheim GmbH, Germany
- Integrated Cleanroom Technologies, Hyderabad – Andhra Pradesh, India (*See ad on page 33*)
- JR Fibreglass Industries Pvt. Ltd., Mumbai – Maharashtra, India
- Kleen Enviro Systems Pvt. Ltd., Pune – Maharashtra, India
- MRC Systems FZE, Dubai, United Arab Emirates
- Novindustria AG, Sissach, Switzerland
- Rosenmund VTA AG, Liestal, Switzerland
- Sartorius India Group, Bangalore – Karnataka, India
- Stilmass, Milano, Italy
- TECNinox Srl, Parma, Italy



Automated operations in cleanrooms to avoid product exposure.

switches are provided to monitor the nitrogen pressures which are interlinked to a control system.

This blanketing system provides the following advantages:

- Ensure proper inert atmosphere in the centrifuge for safety.
- Avoids the loss of nitrogen, thereby reducing nitrogen consumption by 90%, saving much energy.
- Since the system is closed, it avoids solvent loss to the atmosphere thereby saving the environment from pollution.
- Ensures consistent product quality and less human exposure and operator interference.

### High Level of Automation

The new facility features a high level of automation to precisely control process parameters, e.g., vacuum distillation, batch distillation, batch monitoring, and automation of process equipment, such as the reactor, centrifuge, driers, and utilities. All equipment is automated with a Distributed Control System (DCS) and Programmable Logical Controllers (PLCs) – technological tools commonly available on the market, but unique in API manufacturing, according to Orchid.

Orchid claims to be the first Indian bulk API manufacturer to implement a DCS for batch process. Reactors' utilities such as air, -10 Deg, -40 Deg, +10 Deg, and nitrogen are controlled by a DCS to maintain accurate process parameters. In addition, some of the reactors are equipped with Variable Frequency Drive (VFD) as per application based on process requirements.

For Orchid, a DCS not only offers operational ease, but also helps reduce batch time, and in turn, helps conserve energy.

### Conclusion

When Orchid Chemicals & Pharmaceuticals began to create a new facility with modern and flexible cGMP aspects to manufacture internationally acceptable products, its staff knew that new technologies would be necessary; and they met the bold challenge successfully. With the high degree of facility automation, innovative energy conservation measures, and one of the first cGMP operational systems for bulk API handling in India, Orchid has become a model for other organizations building facilities in the region. 

# Roche Pharma Biotech Production Basel

## Skillful Orchestration of a Complex Project

### Introduction

To provide additional production capacity for the API of Avastin®, a successful new treatment medication in the fight against cancer, Roche Pharma Biotech Production Basel built the **MAB Building 95** in Basel, Switzerland.

Winner of the **2009 Facility of the Year Award for Project Execution**, this ultra fast track project was delivered in the middle of a busy residential area of Basel. The small and unique footprint of this Monoclonal Anti Bodies (MAB) facility and complex construction site logistics tested the ingenuity of the project team at every turn.

### Center of a Transformation

Headquartered in Basel, Switzerland, Roche is one of the world's leading research-focused healthcare groups in the fields of pharmaceuticals and diagnostics. At its headquarters, Roche operates a second European Center of Excellence for Biotechnology, in parallel to the Biologics IV center in Penzberg, Germany – a project that won the 2008 Facility of the Year Award for Project Execution.

The Basel site is being transformed from its traditional chemicals and pharmaceuticals production background to a center of excellence for biologics and pharmaceuticals. Roche representatives say the MAB 95 building is the nucleus for this future.

Erected on the plot of a former chemical production plant, the new building stands 40 meters tall with eight floors above ground and two floors underground. The multiproduct facility allows simultaneous production of two different products. It comprises 6 × 12.5 m<sup>3</sup> fermentation capacity plus two down stream processing lines for purification, and associated utilities, laboratories, and offices.

### Construction Outside of the Box

The confines of the site – in a residential area in the middle of Basel city – restricted the size of the construction plot to 60 by 30 meters with no available lay-down area. Construction staff occupied a project office located on an elevated platform over

## Roche Pharma Biotech Production Basel

Category Winner – Project Execution

**Project:** MAB Building 95

**Location:** Basel, Switzerland

**Size:** 209,896 sq. ft. (19,500 sq. m.)

**Total Project Cost:** \$370 million

**Duration of Construction:** 19 months



Placing a vessel in the pit under the future main entrance.

the main public roadway.

To reduce congestion in and around the already tight project site, cutting-edge communication technology was applied whenever possible, in the day-to-day running of the project. Extensive use was made of video conferencing, documentation was exchanged via the Internet prior to joint reviews, site access was restricted to key personnel, and all project participants were encouraged to conduct as much communication as possible through electronic media. This allowed a large reduction in travel time and cost.

Space restrictions forced the project team to develop a “just in time” logistics program for both equipment manufacturing and site logistics.

Key elements of this approach to a biotech project were:

- The complete 100% 3D CAD modeling of process and utility pipe work
- The remote, off-site workshop, delivering “just in time” manufactured equipment and piping spools built precisely to the 3D CAD isometric drawings
- A very detailed construction schedule, broken down to daily delivery and work packages with aligned progress monitoring
- The extensive pre-commissioning FAT program at supplier's workshop
- Full integration of suppliers into team scheduling, synchronized timing, and delivery routes

### A Vertical Submarine

The confines of the site forced the project team to take a new approach toward the building concept and layout, often described

*Continued on page 38.*



# Teamwork is the key to success.

And a great way to win awards.

**Linde-KCA-Dresden congratulates Roche on winning the Facility of the Year Award 2009 for its new MAB facility in Basel! As the main contractor for the engineering of the plant, Linde-KCA-Dresden is honored to have been involved in the successful design and execution of this highly complex project.**

Linde-KCA-Dresden serves clients from its main office in Dresden, the office for the Basel region in Lörrach and further offices in many countries around the world, including Russia, India, the UAE, Saudia Arabia, the USA, Brazil and China.

Linde-KCA-Dresden is a world-leading company in the planning and construction of biotechnological, pharmaceutical, chemical and gas plants. Our biotechnological/pharmaceutical spectrum includes plants for:

- Pharmaceutical (Red) Biotechnology
- Chemical active pharmaceutical ingredients
- Fractionation of blood plasma
- Pharmaceutical finished dosage forms
- Industrial (White) Biotechnology
- Fine chemicals
- Food additives

**Linde-KCA-Dresden GmbH**

Bodenbacher Strasse 80, 01277 Dresden, Germany

Phone +49.(0)3 51.250-35 12, Fax +49.(0)3 51.250-48 00, [lkca.biotech@linde-kca.com](mailto:lkca.biotech@linde-kca.com), [www.linde-kca.com](http://www.linde-kca.com)

as a vertical submarine.

The production process clearly dictated equipment arrangement which the architecture had to balance against the overall aesthetics of the building and its environment.

Utilizing a top down process flow resulted in the tank farm with all media and buffer tanks located on the second top floor. This makes MAB Building 95 the only production building with liquid storage 35 m above ground. This unique

layout, providing liquid flow under gravity (with support from pressurized nitrogen when necessary) works well and saved many pumps – beneficial for the facility's sustainability, investment costs, and maintenance effort and costs, said representatives from Roche.

## Strategy through Scheduling

Since the facility had to be arranged vertically and all systems are fully integrated (piping as well as automation),

the normal option of sequential completion proved to be too slow when modeled in the schedule. This forced the project team to develop the strategy and tactics necessary to complete the whole facility as a single entity, i.e., work on everything in parallel. This extremely aggressive schedule dominated the project execution strategy.

High emphasis was placed on very detailed planning and scheduling of tasks. Great attention was focused on weekly progress reviews where the achieved physical progress for all disciplines was audited and corrective actions were agreed upon if any schedule slippage was identified. This meticulous planning, scheduling, and execution of the plan was another critical success factor of the ultra fast track project management methodology.

The resources and tools required to plan at this depth were provided in all phases of the project. A primary focus for the project team was the synchronization of the interfaces between phases. This assured seamless workflow not only in the distinct project phases, but also through these interface periods. This removed the productivity reduction often seen during funding period activities when a project team is focused on securing funding for the next project phase. These techniques produced the following results:

- The first DCS – controlled fermentation run (October 2006) was running in the installed equipment 33 months after the start of concept design.
- Handover of the building (May 2007) was six weeks ahead of the original ultra fast track schedule.

To achieve this, many activities were run in parallel and multiple acceleration programs were employed:

- After the project start in July 2004, the building's basic design was accelerated to apply earlier for a construction permit, typically a lengthy process due to the site location in a residential zone.
- Demolition of existing building started immediately with excavation work starting two months later.

## Partner of the Winner



## GEMÜ - your first choice for stainless steel diaphragm valves

- **Hermetic sealing - EHEDG certified**  
The original GEMÜ diaphragm seal system, minimum deadleg, reliable sealing even with abrasive particles
- **Exceptional service life and high reproducibility**  
Filling, mixing, separating – and easily sterilised (SIP) and cleaned (CIP)
- **Eminently suitable for automation and control systems**  
Positioners, position indicators, combi switchboxes, field bus solutions and more
- **Wide selection of valve bodies and configurations**  
The largest selection of valve bodies, T-valves, tank valves, valve clusters, multipoint blocks and customized solutions

**GEMÜ®**

ACHEMA  
11.-15. May 2009  
Hall 8, Booth K48-M52

GEMÜ Gebr. Müller Apparatebau GmbH & Co. KG · Fritz-Müller-Str. 6-8 · D-74653 Ingelfingen  
Phone 07940/123-0 · Telefax 07940/123-224 · info@gemue.de · www.gemue.de

Continued on page 40.

Bayer AG .....  
 Pfizer .....  
 Lek Pharmaceuticals .....  
 GlaxoSmith Kline .....  
 Smithkline Beecham Pharmaceuticals .....  
 BRI .....  
 BASF AG .....  
 Interbio .....  
 Sandoz .....  
 ARC International .....  
 Eden-Waren .....  
 TMI .....  
 Miles, Inc. ....  
 Biotechnikum .....  
 EuroCetus .....  
 Sclavo SpA .....  
 Pasteur Merieux Connaught .....  
 Gist-Brocades .....  
 Südzucker AG .....  
 Lonza AG .....  
 Genzyme Biochemicals .....  
 Lignozym .....  
 EBEWE Pharma GmbH .....  
 Lonza Biotec s.r.o. ....  
 AKZO Intervet International BV .....  
 Amgen, Inc. ....  
 Ciba-Geigy .....  
 Antibioticos .....  
 Werthenstein Chemie AG .....  
 Bio-Intermediar BV .....  
 Lederle, Inc. ....  
 Shanghai United Institute of Cell Biology ..  
 Rauch Fruchtsäfte GmbH & Co .....  
 Bio-Intermediar, Inc. ....  
 Fluka .....  
 Pharmaplan Deutschland GmbH .....  
 Medarex, Inc. ....  
 Wyeth Lederle .....  
 Snamprogetti Biotecnologie .....  
 Instituto Nacional de Higiene .....  
 Cerestar Deutschland GmbH .....  
 Astra Zenaca .....  
 Novartis Pharma AG .....  
 Tecnogen S.C.p.A. ....  
 LG Chem .....  
 Universiti Teknologi Malaysia .....  
 Sanofi-Aventis .....  
 DSM Biologics .....  
 Biotechnology General .....  
 Acambis, Inc. ....  
 Allergan Pharmaceuticals, Inc. ....  
 Strathmann Biotech .....  
 Wockhardt Ltd. ....  
 Kyowa Hakko Kogyo Co. Ltd. ....  
 Laboratorios Hipra, S.A. ....  
 Regeneron Pharmaceuticals, Inc. ....  
 Avecia Ltd. ....  
 Laboratoires Serono SA .....  
 Cerbios-Pharma SA .....  
 GPO .....  
 Biovitrum AB .....  
 BT Biotech Pharmaceuticals Co. Ltd. ....  
 CP Guojian Pharmaceutical Co. Ltd. ....  
 Celltrion, Inc. ....  
 Dongbao Enterprise Group Co. Ltd. ....  
 Suzhou Landing Biopharmaceutical Co. Ltd. ....  
 Zhejiang Hisun Pharmaceutical Co. Ltd. ....  
 Daiichi Suntory Pharma Co. Ltd. ....  
 Dr. Reddy's Laboratories Ltd. ....  
 Serum Insitute of India Ltd. ....  
 Center of Molecular Immunology .....  
 Phyton Biotech GmbH .....  
 Panacea Biotech Ltd. ....  
 Sacco S.r.l. ....  
 Novo Nordisk A/S .....  
 Allergopharma Joachim Ganzer KG .....  
 Rentschler Biotechnologie GmbH .....  
**F. Hoffmann-La Roche** .....  
 Serono France S.A. ....  
 Chengdu Institute of Biological Products ...  
 China Biotech Wuhan Institute of Biological  
 Products .....

# Bio XXL

Bioengineering AG – large-scale bioreactor projects.



**Biotechnologische  
 Wirkstoffanlage MAB • Bau 95**  
 Bauzeitraum: 2004 bis 2007



**Bauherr**  
 F. Hoffmann-La Roche AG

**Projektleitung**  
 F. Hoffmann-La Roche AG, Technical Service Basel & Kaiseraugst (PST)  
 F. Hoffmann-La Roche AG, Pharma Global Engineering (PTE)

**Planer**  
 Hauptkontraktor für  
 Planung und Koordination Linde - KCA - Dresden GmbH

**Gebäude**  
 Architektur und Planung Herzog & de Meuron  
 Statik und Tragwerksplanung ZPF Ingenieure AG  
 Baustellenrichtung Proplaning AG  
 Fassadenplanung Emmer, Pfenninger + Partner AG  
 HLKKS-Planung Aximis AG / Ingenieurbüro Mayer AG  
 Elektro-/Gebäudeautomation KNIW Systemingenieure und Berater AG

**Prozesstechnik**  
 Fermentation Bioengineering AG

**Construction Management**  
 Construction Management Bovis Lend Lease AG  
 Bauleitung Bovis Lend Lease AG  
 Bauleitung Gebäudetechnik Gruneko AG  
 Bauleitung Prozesstechnik Chemengineering AG

Congratulations to Roche, the Facility of the Year  
 Award Winner for Project Execution!

We are proud to be part of it!

**BIOENGINEERING**

Bioengineering AG, 8636 Wald, Switzerland  
 Tel. +41 (0) 55 256 8111, Fax +41 (0) 55 256 82 56  
 Bioengineering, Inc., Waltham, MA 02451, USA  
 info@bioengineering.ch, www.bioengineering.ch

## Why Our Project Should Win

The following is an excerpt from Roche's submission, stating, in their own words, the top reasons why their project should win the 2009 Facility of the Year Award:

- Exemplary project management and leadership, excellence in project procurement, expediting, and quality control
  - Empowering and integrating the whole project team of service providers, suppliers, trade contractors, architects, designers, engineers, and Roche
  - Integration of 24 different nationalities and languages, recruited Europe wide, into a unified, motivated team
  - Great team-spirit and outstanding focus on ultimate project goal
  - Implementation of innovative design and execution strategies as well as novel project management methodologies to achieve ambitious project goals
  - Sophisticated expediting including extensive progress and quality control at the suppliers' workshops (also for the automation package) to ensure timely delivery of high quality packages
  - "Just in time" delivery of equipment and materials to the construction site in pre-determined time slots
- Excellence in execution of an Ultra Fast Track project
  - Excellent task planning and resource management allowing seamless workflow and motivating the workforce to increase effort
  - Delivering a high quality, architecturally unique but space constrained facility six weeks ahead of a fast track schedule
  - 100% tested functionality (process, building, automation) and qualification reports approved at the time of handover
- Project 9% below cost budget (which had no provisions for fast track actions)
- Excellence in facility integration
  - Unique as being the only biotech production facility with vertical layout and having a tank farm on top, making most possible use of gravity flow
  - Unique in combining the functionality and requirements of a biotech production facility with inner-city, unique, and state-of-the-art architecture with full glass curtain wall façade
- A true 100% 3D CAD Building Information Model (BIM) model and a unique approach of integration of the modeling with the project schedule
  - Each item in the facility 3D CAD model was linked to an activity in the project schedule.
- Excellence in construction management
  - Very early integration of CM into project team, working on constructability analysis and administering trade contracting
  - Establish construction site with no usable space on the ground
  - Establishing highly sophisticated construction schedule, synchronizing interfaces to design and engineering, equipment and materials delivery, spool piece pre-manufacturing and coordinating the trades on site
  - Organize and coordinate trades and workforce on construction site (at peak time 500 workers) to assure uninterrupted workflow and under the pressure of constant competition for space to work
  - Daily physical progress monitoring with weekly reporting

- Procurement for the building shell trade contractor and the other major building trades started immediately to facilitate an early construction start.
- An extensive procurement program based on competitive bidding was coordinated with the Biologics IV project in Penzberg.
- Exhaustive acceleration program during detail design mainly for piping isometrics, HVAC ducting, and electrical wiring supported an early start of mechanical installations.
- A sophisticated building construction schedule secured six weeks for a basement floor and three weeks for a super structure floor.
- Infrastructure mechanical installation in the basement began while the concrete for the above ground floors had yet to be poured.
- Acceleration program for piping and HVAC installation
- Since all mechanical systems were interconnected, commissioning, start-up, and qualification of utilities and process units were performed in sequence.
- The start-up team was staffed as much as possible with future production crews.

- Introduction of technical batches (non-qualified runs under production conditions) during start-up allowed for early detection of flaws and reduced time for remedial work.

## Teamwork at its Best

High ethical standards were set for project management and leadership. The primary areas of focus were on:

- teamwork and team motivation
- engagement and empowerment of team members
- building an environment of integrity and trust in the team
- working together with contractors and suppliers in a spirit of open team partnership

"No blame, fix the problem," was an overriding principle that led Roche's integrated project team. The contracting strategy based on reimbursable cost contracts with prime contractors and incentive schemes supported this environment.

A Roche philosophy is to take ownership and actively manage project risks instead of delegating them. In this project, the

*Concludes on page 42.*



**sartorius stedim**  
biotech

# Congratulations to Roche

Winner of the "Facility of the Year" Category Award for Project Execution

As a long-term project partner and key supplier to Roche, we would like to congratulate you on achieving this splendid award.

We at Sartorius Stedim Biotech take pride in working with our customers to achieve one common goal: the best and most innovative solution for their process.

There's more to it than just supplying products. We work side by side with our partners right from the early development stages and on up along the entire process chain. We understand that every process is unique and calls for a custom-tailored solution.

Take our efficient virus clearance concept, for instance. Our orthogonal platform comprises technologies like:

- UVivatec® for virus inactivation by exposure to UV-C light
- Virosart® nanofilters for virus removal through size exclusion
- Sartobind® for virus adsorption by membrane chromatography

Find the winner: uniquely tailored solutions throughout your entire process.





## Notes from the Judging Panel – What Impressed Them

*This is the sister project to last year's winning project in the same category, but this one is in Basel. It was well coordinated for such a complex project in a very busy area. It sits right in the middle of a residential area with no onsite storage. They had to truck in materials over 10 miles. It is a vertical MAB facility, which is unique in the industry. Because of lack of space, an elevated office above Basel's street traffic was constructed for project management staff. Very innovative for the space they had to work with.*

benefits of this philosophy were proven. Support was provided by all parts of the Roche organization and their experts as critical issues surfaced or interfaces were to be managed. The project was able to call for additional support anytime and was given priority. Peer reviews for design and project management were

### Key Project Participants

**Owner:** Roche Biotech Basel

**Engineering:** Roche Pharma Global Engineering and Roche Basel site Engineering

**Designer/Architect/Engineer:** Herzog & deMeuron, Basel, Switzerland

**Construction Manager:** Bovis Lend Lease, Munich, Germany (liquidated)

**Main/General Contractor:** Linde – KCA, Dresden, Germany  
(See ad on page 37)

**Piping Subcontractor:** MCE, Salzburg, Austria

**HVAC Subcontractor:** Axima, Basel, Switzerland

**Automation and Control Supplier:** Siemens Swiss, Zürich, Switzerland

#### Major Equipment Suppliers:

- ABB Secheron, Baden-Dättwil, Switzerland
- ABB Swiss, Baden-Dättwil, Switzerland
- Alfa Laval, Tumba, Sweden
- Apaco, Grellingen, Switzerland
- Balzaretto & Frey, Udligenswil, Switzerland
- Bioengineering, Wald, Switzerland (See ad on page 39)
- Calorifer, Elgg, Switzerland
- GEA Dissel, Niedersachsen, Germany
- Gecma, Kerpen, Germany
- Gemü, Ingelfingen, Germany (See ad on page 38)
- Glatt, Wiesbaden, Germany
- Karasek, Gloggnitz-Stuppach, Austria
- Mavag, Neunkirch, Switzerland
- Millipore, Molsheim, France
- Pall, Dreieich, Germany
- Pharmatec, Wiesbaden, Germany
- Ramseyer, Flamatt, Switzerland
- Renggli, Rotkreuz, Switzerland
- Sartorius, Goettingen, Germany (See ad on page 41)
- Sauter, Basel, Switzerland
- Stedim, Fribourg, Switzerland
- Zeta, Graz, Austria



Test runs under production conditions.

carried out by colleagues from the worldwide Roche engineering network.

Much effort was invested in project definition (e.g., user requirements) and project execution planning during project initiation, where organizational setup, roles, responsibilities, and execution strategies were defined to support achievement of project goals. Best practice engineering processes were applied in all disciplines.

Current project control best practices are standard processes in Roche and are successfully applied in all Roche projects. Special efforts were made on controlling the scheduling of critical path items and on the enabling of early commissioning of 100% completed systems. Together with focused acceleration programs, these were the most important planning measures for schedule reduction.

Sophisticated resource planning including the application of different shift-models ensured staffing levels, avoidance of work overload, especially on the user side and automation, and enabled recruitment of the plant operatives to be complete early in the project.

Since the production group had to be established from scratch by recruiting knowledgeable operators, some of whom were new to biotechnology and without specific experience, intensive training programs were established. In cooperation with the Zürich College in Wädenswil, training was provided in theoretical background, and experience with large scale production was shared by colleagues from Roche Penzberg and Genentech.

### Conclusion

Delivering an ultra fast track biotechnology facility is a huge challenge for a project manager by itself. To combine this challenge with the added dimension of a restricted site footprint, city center construction logistics, residential neighborhood, and a star architect with strong views on design and material selection called for innovative project management techniques. The project team at Roche Pharma Biotech Production Basel shined while delivering an ultra fast-track, completely unique, vertical MAB facility. Every aspect of this project had to be flawlessly executed to accommodate the many challenges of the site, location, and facility design. The result was a skillfully orchestrated project delivered six weeks ahead of an already aggressive schedule. 

Need Knowledge? No Budget for Travel?



## No Problem.

ISPE Online Learning delivers critical knowledge and training to you anytime, anywhere, and at a price to fit your budget.

Go to [www.ISPE.org/onlinelearning](http://www.ISPE.org/onlinelearning) for a complete list of Web-based learning opportunities or call ISPE Member Services at tel: [+1-813-960-2105](tel:+1-813-960-2105).



## GlaxoSmithKline Manufacturing

# Advancing the Aseptic Powder Filling Process

### Introduction

**G**laxoSmithKline's (GSK) Italian operations have been based in Verona, Italy since 1932 and the region has become a center of excellence for the production of sterile cephalosporin powder products.

Knowing that the greatest risk to sterile processes is the possibility of people contaminating the product, GSK decided to create the necessary conditions for its production process to take place without people being present in critical areas. The decision resulted in the revamping of their Verona **Aseptic Powder Filling Facility 4** – the **2009 Facility of the Year Award Honorable Mention**.

### Filling the Need for a Better Process

At GSK's Verona site, production of bulk sterile vials is carried out in a dedicated building, designed to work as four fully independent filling lines. In each line, the vials are washed in an automatic washing machine and thermally treated by dry heat in a unidirectional flow depyrogenation tunnel. The sterile vials are automatically filled and plugged inside the cleanroom. The closed vials are transported by a belt protected by a unidirectional air flow toward the over-sealing stations located adjacent to the filling room. After application of the over-seal, the vials move on to the inspection station where each vial is inspected visually and laser marked on the neck with the identification data. After marking, the vials are packed in a cardboard tray, ready for further packing operations.

In 2006, GSK's production line number four was radically restructured and modernized. On the basis of the experience gained during previous projects, Verona tried to define and implement the best possible application of the concept of Restricted Access Barrier System (RABS) to protect the vials being filled with antibiotic powder. Application of RABS avoids the operator coming into direct contact with critical areas of the process.

The aseptic filling of powder requires a challenging ap-

## GlaxoSmithKline Manufacturing

Honorable Mention

**Project:** Revamping of Aseptic Powder Filling Facility 4

**Location:** Verona, Italy

**Size:** 150,695 sq. ft. (14,000 sq. m.) – Filling Facility Floor Area

**Total Project Cost:** \$6.3 million

**Duration of Construction:** 4 months



Aseptic powder filling facility.

proach, compared to the aseptic filling of liquid. While RABS and CIP/SIP to point of fill is readily applicable to the liquid filling process, the technology associated with powder filling is rather outdated and requires significant manual aseptic assembling of the equipment components. Powder filling is a completely different matter, involving frequent format changes, consistent ingress of materials (i.e., plugs, API), and a facility with traditional cleanroom design and services. These considerations make isolator technology simply not affordable, said GSK representatives.

GSK needed a process that would assure a proper protection for set-up, routine operations, and materials transfer, while maintaining all of the experience gained in traditional cleanrooms. The Aseptic Powder Filling Facility 4 would be the project that would satisfy their protection needs and consequently take aseptic production to a higher level.

### Creating an Innovative Template

The target of the project was to implement technological and operating solutions to assure, in the long term, a state-of-the-art process suitable for the antibiotic business as an alternative to isolator technology. This included an innovative approach to equipment, environment, handling, and storage that is unique in the industry. GSK effectively created a template for aseptic powder filling and designed several elements specifically for this project to make the process reliable and repeatable.

The revamp of GSK's Aseptic Powder Filling Facility 4 was completed in March 2007. The main features of the new facility are:

- Product contact machine parts pre-assembled before sterilization

*Concludes on page 46.*

# Genetically modified technology



## MAC • Modular Aseptic Compact System

Incorporating a vial washer, depyrogenating tunnel, filling, stoppering and alu-capping **into a single compact integrated system** for liquid, lyo or powder, with RABS or Isolator **in 20% of the space.**



IMA LIFE S.r.l.  
mktg.filling@ima.it • www.ima.it  
IMA NORTH AMERICA, INC.  
sales@imausa.net • www.imanorthamerica.com • www.ima.it

**IMA LIFE**  
Aseptic Processing & Filling Solutions

## Notes from the Judging Panel – What Impressed Them

*Very innovative technologies for handling powder. They overcame a lot of challenges with aseptic powder filling in a really unique way. They found a way to template the process so that they can repeat it the same way every time, which is very practical and reliable. They designed several elements specifically for this project to make the process repeatable.*

*Haven't seen anything like this in the industry.*

- Semiautomatic setup completed using glove ports
- Grade A continuity
- Routine operations performed using glove ports
- Enhanced protection of operators from API
- Increased line performances
- In-line particle counting monitoring

As in the traditional cleanroom process, the production begins in the aseptic area with the preparation of the filling machine. To avoid manually assembling the numerous pre-sterilized components of the machine, exposing them to the risk of contamination, they are pre-assembled on a single plate before sterilization. The plate, with the pieces pre-connected and arranged in the definitive configuration, is supported by a special chassis enabling it to be transported and coupled to the machine. The chassis, complete with the plate and all the pre-assembled pieces, is sterilized in the autoclave as a single unit. Once sterilized, the parts in contact with the product, the components and closures, are transported to the point of use by means of a special trolley with protective barriers.

Today, each sterile component is assembled in the filling machine using automatic systems and devices. Assembly is completed without any direct contact between the operators and the sterilized components. The operator remains on the other side of the barrier, keeping him away from critical objects, thus improving the safety of the production.

To ensure sterility of sterile product contact parts, equipment, and closures while traveling from the autoclave to their point of use, a Barrier Protected Trolley (BPT) is used. The trolley has

### Key Project Participants

**Designer/Architect/Engineer:** GSK Manufacturing Verona staff

**Construction Manager:** GSK Manufacturing Verona staff

**HVAC Subcontractor:** STERIL manufacturing division, Milano, Italy

**Major Equipment Supplier:** IMA Life, Bologna, Italy

*(See ad on page 45)*



Core of the aseptic area.

been designed to ensure that contained items have a constant flow of unidirectional grade A air sweeping over their surfaces and out from the cabinet without entrainment or entrapment of air from the external environment air under static and dynamic conditions. The BPT runs on rails, facilitating the operator on repeatable routes.

The project was developed by the GSK site engineering team, working in strong partnership with the supplier of the filling machine (IMA) for the modifications to the machine's core and assessing the innovative solution on prototypes.

### Conclusion

After the release in production, the continuous support of the site engineering team allowed an impressive performance improvement and the development of new solutions in material handling.

With talent, skill, and motivation from the Verona work group and supplier IMA, a step forward has been taken in guaranteeing the sterility of the aseptic powder filling process. The Verona factory is now able to provide patients with an even safer product. 



Transfer on rails of the chassis at the end of the campaign (without BPT).

ISPE would like to thank  
the following companies  
for their generous advertising support  
which made this  
Supplement possible.

## Advertiser's Index

ADVENS .....	21
BIOENGINEERING .....	39
BOSCH PACKAGING TECHNOLOGY .....	29
CRB CONSULTING ENGINEERS .....	11
DALDROP + DR. ING. HUBER .....	3
ENGUARD SYSTEMS .....	7
GEMÜ .....	38
HAMELN PHARMACEUTICALS .....	27
HOF SONDERANLAGENBAU .....	20
IMA LIFE – MAC .....	45
INTEGRATED CLEANROOM TECHNOLOGIES LTD ...	33
JOHN SISK AND SON .....	15
KELLS STAINLESS LTD .....	14
KOPPENHÖFER + PARTNER .....	28
LETZNER PHARMAWASSERAUFBEREITUNG .....	31
LINDE – KCA .....	37
METALL + PLASTIC .....	19
NNE PHARMAPLAN .....	25
OPTIMA GROUP .....	22
PM GROUP .....	11
PROSCON .....	13
SARTORIUS .....	41

The Facility of the Year Award  
is sponsored by:



**FACILITY OF THE YEAR  
SUPPLEMENT STAFF**

### Publications

Editor and Director of Publications

Gloria N. Hall

Publications Manager

Lynda D. Goldbach

Technical Writer

Rochelle Runas

Publications Coordinator

Amy Lecceardone

### Sales

Director of International Sales

David J. Hall

Sales Coordinator

Valerie Adams

European Sales Manager

Christine Sainvil

### Marketing Communications

Communications Manager

Marni Schribman

[www.facilityoftheyear.org](http://www.facilityoftheyear.org)



## Facility of the Year Awards 2010 Call for Entries

**T**he Facility of the Year Awards are an annual program that recognizes state-of-the-art pharmaceutical manufacturing projects that utilize new and innovative technologies to both improve the quality of the project and to reduce the costs of producing high-quality medicines. The Awards program is unique because it provides a platform for the pharmaceutical manufacturing industry to showcase its new products and accomplishments in facility design, construction, and operation.

The program, its Category Winners, and the Facility of the Year Award Overall Winner will receive high-profile attention and media coverage from ISPE, INTERPHEX, and *Pharmaceutical Processing* magazine.

*Belgium. Canada. France. Germany. India. Ireland. Italy. Japan. Singapore. Spain. Sweden. Switzerland. United Kingdom. United States.*

Companies from around the world have already submitted their state-of-the-art facilities to participate in the Facility of the Year Awards program, and we'd love to hear from you. ISPE, INTERPHEX, and *Pharmaceutical Processing* magazine are looking to highlight projects that demonstrate global leadership by showcasing cutting-edge engineering, innovative new technology, or advanced applications of existing technology.

**Don't let your company pass up this outstanding opportunity to showcase its new or renovated facility!**

For additional information about the Awards program and submission procedures, visit [www.facilityoftheyear.org](http://www.facilityoftheyear.org).



## Architects, Engineers – Constructors

CRB Consulting Engineers, 7410 N.W. Tiffany Springs Pkwy., Suite 100, Kansas City, MO 64153. (816) 880-9800. See our ad in this issue.

EI Associates, 8 Ridgedale Ave., Cedar Knolls, NJ 07927. (973) 775-7777. See our ad in this issue.

Parsons, 150 Federal St., Boston, MA 02110. (617)-946-9400. See our ad in this issue.

## Cleanroom Products/Services

AES Clean Technology, 422 Stump Rd., Montgomeryville, PA 18936. (215) 393-6810. See our ad in this issue.

Plascore, 615 N. Fairview, Zeeland, MI 49464. (800) 630-9257. See our ad in this issue.

## Consultants



## Employment Search Firms

Jim Crumpley & Associates, 1200 E. Woodhurst Dr., Bldg. B-400, Springfield, MO 65804. (417) 882-7555. See our ad in this issue.

## Homogenizers

GEA Niro Pharma Systems, 9165 Rumsey Rd., Columbia, MD 21045. See our ad in this issue.

## Instrumentation

Hach Ultra Analytics, 5600 Lindbergh Dr., Loveland, CO 80539. (970) 663-1377. See our ad in this issue.

## Passivation and Contract Cleaning Services

Active Chemical Corp., 4520 Old Lincoln Hwy., Oakford, PA 19053. (215) 676-1111. See our ad in this issue.

Cal-Chem Corp., 2102 Merced Ave., South El Monte, CA 91733. (800) 444-6786. See our ad in this issue.

## Rupture Discs

Fike Corp., 704 SW 10th St., Blue Springs, MO 64015. (816) 655-4546. See our ad in this issue.

## Sterile Products Manufacturing



## Tanks/Vessels

Lee Industries, PO Box 688, Philipsburg, PA 16866. (814) 342-0470. See our ad in this issue.

## Temperature Control Systems

Budzar Industries, 38241 Willoughby Pkwy., Willoughby, OH 44094. (440) 918-0505. See our ad in this issue.

## Used Equipment

### PRE-OWNED FREEZE DRYERS

**Hull Model 8FS12** – Chamber ASME Code design for 0 psig, stainless steel construction including shelves, chamber, chamber door, (5) product shelves, (4) useable 12" wide x 24" deep, 4.5" clearance between shelves, stoppering from bottom up, hydraulic pumping system, internal ice condensing plates providing 12 liters capacity, vacuum pump, refrigeration heat transfer system with 2 KW heater, circulation pump, interconnecting piping, expansion tank, heat exchangers, Voltage 220 volts, 60 cycles, 3 phase.

**Hull Model 36FS75** – Chamber ASME Code design for 0 psig, all stainless steel construction including shelves, chamber, chamber door, (7) product shelves, (6) useable 24" wide x 36" deep, 4.5" clearance between shelves, stoppering from top down, hydraulic pumping system, internal ice condensing plates providing 50 liters capacity, vacuum pump, refrigeration heat transfer system with heater, circulation pump, interconnecting piping, expansion tank, heat exchangers, Voltage 220 or 460 volts, 60 cycles, 3 phase.

**Hull Model 48FS75** – Chamber ASME Code design for 0 psig, all carbon steel construction including shelves, chamber, chamber door, coated with Kynar (9) product shelves, (8) useable 24" wide x 36" deep, 4.5" clearance between shelves, stoppering from top down, hydraulic pumping system, internal ice condensing plates providing 75 liters capacity, vacuum pump, refrigeration heat transfer system with heat transfer heater, circulation pump, interconnecting piping, expansion tank, heat exchangers, Voltage 220 or 460 volts, 60 cycles, 3 phase.

**Hull Model 120FXS200** – Chamber ASME Code design, all carbon steel Heresite coated construction including shelves, chamber, chamber door, (11) product shelves, (10) useable 36" wide x 48" deep, 4.5" clearance between shelves, stoppering from top down, hydraulic pumping system, external ice condensing plates providing 200 liters capacity, vacuum pump, refrigeration heat transfer system with 20 KW heater, sealless circulation pump, interconnecting piping, expansion tank, heat exchangers, Voltage 460 volts, 60 cycles, 3 phase.

## Lyo Renew Associates, Inc.

548 Pinney Road, Huntingdon Valley, PA 19006  
Phone: 215-817-6942, Fax: 215-947-5768  
info@lyorenew.com, www.lyorenew.com

## Valves

Gemu GmbH & Co., Fritz-Mueller-Str. 6-8, D-74653 Ingelfingen, Germany. +49 7940123-0. See our ad in this issue.

Gemu Valves, 3800 Camp Creek Pkwy., Bldg. 2600, Suite 120, Atlanta, GA 30331. (678) 553-3440. See our ad in this issue.

## Water Treatment

Eletracqua Srl, Via Adamoli 513, 16141 Genova, Italy. +39 0108300014. See our ad in this issue.

## JIM CRUMPLEY & ASSOCIATES

### Pharmaceutical Recruiting Specialist

Put our expertise to work for you in:

- Facilities
- Project
- Process
- Validation
- Automation
- Quality Engineering

1200 E. Woodhurst Drive, B-400 • Springfield, MO 65804

Phone: 417-882-7555 Fax: 417-882-8555

E-mail: [recruiter@crumpleyjobs.com](mailto:recruiter@crumpleyjobs.com)

Web site: [www.crumpleyjobs.com](http://www.crumpleyjobs.com)

*We've been getting results since 1977!*



ACTIVE CHEMICAL .....	67
AES CLEAN TECHNOLOGY .....	25
BUDZAR INDUSTRIES .....	17
CAL-CHEM CORP .....	29
COMMISSIONING AGENTS .....	23
CRB CONSULTING ENGINEERS .....	3
JIM CRUMPLEY & ASSOCIATES .....	68
EI ASSOCIATES .....	43
ELETRACQUA .....	13
EMERSON PROCESS MANAGEMENT .....	9
ENDRESS + HAUSER .....	71
FARR AIR POLLUTION CONTROL .....	2
FDA/US DEPARTMENT OF HEALTH & HUMAN SERVICES .....	69
FIKE CORP. ....	11
GEA PROCESS ENGINEERING .....	61
GEMU GMBH .....	45
GEMU VALVES .....	53
HACH COMPANY .....	15
HOWORTH AIR TECHNOLOGY .....	41
HURST CORP. ....	43
IMA ACTIVE .....	27
INTELLIGEN .....	39
INTERPHEX365 .....	59
LEE INDUSTRIES .....	67
LJ STAR .....	31
NNE PHARMAPLAN .....	72
PLASCORE .....	29
PARSONS .....	5
PHARMACEUTICAL ONLINE .....	57
QPHARMA .....	7
SAINT-GOBAIN PERFORMANCE PLASTICS .....	33
SIEMENS .....	19
TELSTAR .....	49
W.L. GORE & ASSOCIATES .....	37

## Thank You to our Sponsors

### ISPE Tampa Conference

Platinum Level Sponsorship



**PARSONS**

Lanyards

NCA TECHNOLOGIES / NEOCERAM

### ISPE Brussels Conference

Host Sponsor

**SIEMENS**

### INTERPHEX Member Lounge Sponsors



**middough**

**pharmadule**



## U.S. Department of Health and Human Services Food and Drug Administration

### Career Opportunities

HHS/FDA/CDER/Division of Manufacturing and Product Quality, Office of Compliance, located at our new White Oak campus in Silver Spring, Maryland is recruiting CONSUMER SAFETY OFFICERS, INTERDISCIPLINARY SCIENTISTS (biologists, microbiologists, and chemists), PHARMACISTS and STAFF FELLOWS with backgrounds in quality systems and pharmaceutical manufacturing. Applicants with background in quality assurance, solid oral dosage forms, sterile drugs, and equipment, facilities, utilities, instrumentation, and laboratory analysis are encouraged to apply.

We offer:

- Civil Service Salary at the GS-12/13 level, 73,100.00 - 113,007.00
- Excellent Federal Government Benefits Package (health insurance, life insurance, thrift savings plan, retirement)
- Flexible work schedules
- Opportunities to continue Professional Development
- Annual Leave, Sick Leave, Flexible Spending Accounts and long term care insurance

**GENERAL INFORMATION:** Positions being filled as civil service or U.S. Commissioned Corps require U.S. Citizenship. Permanent U.S. Residents may apply for Staff Fellowship program. Graduates of foreign colleges/universities must provide proof of U.S. education equivalency certification.

**COMPLIANCE OFFICER:** Basic Requirements: Candidates should possess a science degree and specific coursework in an appropriate field of study and professional experience. Candidates with Ph.D. or Master degrees in chemistry, biology, pharmacy, engineering, biochemistry, or a B.S. in one of these areas coupled with substantial industry or inspectional experience, are highly desirable. Basic qualifications required for the above positions, except pharmacy, include: 1) a degree in physical sciences, life sciences, or engineering, which includes 30 semester hours in chemistry, supplemented by coursework in mathematics through differential and integral calculus and at least 6 semester hours of physics, or 2) a combination of education and experience-course work equivalent to a major as described above, plus appropriate experience or additional education. To qualify for higher-graded positions, candidates must have additional amounts of either specialized experience or directly related education. The amount of additional experience or education required depends on the grade of the position. For a pharmacy position, a successful completion of a 5-year course of study leading to a bachelor's or higher degree in pharmacy from an approved pharmacy school, or 1 year of professional pharmacy experience equivalent to at least GS-7, or a 6-year course of study leading to a Doctor of Pharmacy (Pharm.D.); 1 year of professional pharmacy experience equivalent to at least GS-9; or, for research positions, completion of all of the requirements for a master's or equivalent degree in a related scientific field. In addition to a background in those fields, the candidate should have excellent communication skills, both oral and written.

Department of Health and Human Services is an Equal Opportunity Employer and has a Smoke-free workplace. If you are interested in considering employment with CDER's Office of Compliance, DMPQ, please submit your resume with a brief cover letter to Kennerly Chapman at (301) 796 3271 or by e-mail, kennerlyk.chapman@fda.hhs.gov

# ISPE Japan Affiliate Tours US Pharmaceutical Companies

by Osamu Matsumoto and Michael Lucey, ISPE Japan Affiliate

Reprinted from  
**PHARMACEUTICAL  
ENGINEERING®**  
The Official Magazine of ISPE

March/April 2009,  
Vol. 29 No. 2

©Copyright ISPE 2009  
www.ISPE.org

Since its establishment in 2002, the ISPE Japan Affiliate has each year offered its members the opportunity to join a tour of pharmaceutical facilities in the US, combined with follow-up participation at the ISPE Annual Meeting. Planning for the 2008 Plant Tour was provided by Affiliate Directors/Members Shigeru Nakamura, Osamu Matsumoto, Masayuki Akutagawa, and Michael Lucey.

In addition to overseas plant visits, the Tour brings the benefit of broad exposure to ISPE. The 2008 version included a Facility of the Year Award (FOYA) Category Winner, while attendance at the Annual Meeting brought participants into contact with diverse areas of the Society's activities. The expectation is for future broad interaction between Japanese and international COPs, as well as a further level of participation in future ISPE-organized meetings through attendance at educational sessions and presentations.

A total of 13 applicants from Japan signed up for the 2008 Plant Tour/Annual Meeting in Boca Raton, Florida. The mission was made up of three representatives from pharmaceutical manufacturers in Japan, four from engineering companies, three from construction companies, and three from equipment suppliers. The overall itinerary was as follows:

## October

- 21 Depart for United States
- 22 Lonza Biologics (Hopkinton, Massachusetts) and Abbott Laboratories (Worcester, Massachusetts)
- 23 Bristol-Myers Squibb (New Brunswick, New Jersey)
- 24 Schering-Plough (Kenilworth, New Jersey) and Cephalon (Frazer, Pennsylvania)
- 25-29 Attend Annual Meeting (Boca Raton, Florida)
- 30 Paul Mueller Company (Springfield, Missouri, as optional tour)

## November

- 1 Return to Japan

For the Japanese, the period in the US prior to Boca Raton proved to be an invaluable preparation for the Annual Meeting itself; for some, this was even a time to work at overcoming language and cultural challenges. Moreover, the several days together permitted valuable bonding, as well as information exchanges, between Tour members.

The Tour was coordinated around visits to diverse pharmaceutical facilities: an existing biopharmaceutical development facility and a soon-to-be-completed leading-edge bio plant; new as well as renovated facilities for bio-based investigational drugs through to early phase of production; a mega-sized manufacturing plant and its automated warehouse; and a pilot plant for (small molecule) chemical-based drugs synthesis.



Neil Martin of BMS welcomes the plant visitors.

Additionally, Tour participants saw for themselves actual operation of the full-containment facilities, which had contributed to Bristol-Myers Squibb being selected as a Category Winner of 2008 FOYA.

After each plant visit, an internal meeting of Tour members was held in the evening of the same day; general information from observations made and explanations given by plant owners were compiled into a summary report completed while in the US. It was understood throughout that no inside photography of plants visited was permitted and proprietary information had to be respected.

A range of benefits were gained from the Tour. These included a further enhanced recognition of the progress made by pharmaceutical manufacturers and equipment makers in containment, the track record pointing to a mature industry; a better understanding of the development status of biophar-



Japan Affiliate gives an overview presentation at welcome party hosted by the ISPE Delaware Valley Chapter.

*Concludes on page 70.*

# 2009 Facility of the Year Awards (FOYA) Category Winners Announced

Six pharmaceutical manufacturing facilities constructed by companies located in Belgium, India, Ireland, Germany, and Switzerland have been selected as Category Winners in the fifth annual Facility of the Year Awards program sponsored by ISPE, INTERPHEX, and *Pharmaceutical Processing* magazine. The winning companies and respective award categories are:



- **Aseptic Technologies**, located in Gembloux, Belgium, winner of the Facility of the Year Award for Equipment Innovation
- **Centocor Biologics Ireland**, located in Ringaskiddy, Cork, Ireland, winner of the Facility of the Year Award for Sustainability
- **Centocor R&D Schaffhausen**, located in Schaffhausen, Switzerland, winner of the Facility of the Year Award for Facility Integration
- **Hameln Pharma**, located in Hameln, Germany, winner of the Facility of the Year Award for Operational Excellence
- **Orchid Chemicals & Pharmaceuticals**, located in Aurangabad, India, winner of the Facility of the Year Award for Regional Excellence
- **Roche Pharma Biotech Production Basel**, located in Basel, Switzerland, winner of the Facility of the Year Award for Project Execution

In addition, **GlaxoSmithKline Manufacturing** was awarded an Honorable Mention for the company's project in Verona, Italy.

The Facility of the Year Awards (FOYA) program recognizes state-of-the-art pharmaceutical manufacturing projects that utilize new and innovative technologies to enhance the delivery of a quality project, as well as reduce the cost of producing high-quality medicines. Now in its fifth year, the awards program effectively spotlights the accomplishments, shared commitment, and dedication of individuals in companies worldwide to innovate and advance pharmaceutical manufacturing technology for the benefit of all global consumers.



ISPE and *Pharmaceutical Engineering* magazine have released a full-color Facility of the Year Special Edition featuring customized content and case studies of each award-winning project. The FOYA Special Edition will be available online, and the printed version is included with this edition of *Pharmaceutical Engineering*.

The FOYA Special Edition also will have additional distribution at major global industry events, such as INTERPHEX and all 2009 ISPE Conferences, including the 2009 ISPE Annual Meeting where the overall FOYA winner will be announced.

Companies from around the world have already submitted their state-of-the-art facilities to participate in the Facility of the Year Awards program. ISPE, INTERPHEX, and *Pharmaceutical Processing* magazine are looking for projects that demonstrate global leadership by showcasing cutting-edge engineering, innovative new technology, or advanced applications of existing technology. Go to [www.facilityoftheyear.org](http://www.facilityoftheyear.org) to read more about the program and download submission forms. 

Inc. 1955

## ACTIVE CHEMICAL CORP.

SPECIALISTS IN . . .

— LABORATORY CONTROLLED —

- CHEMICAL CLEANING SERVICES OF HEAT EXCHANGE EQUIPMENT
- PASSIVATION OF STAINLESS STEEL PIPING
- STERILIZATION OF PIPING & EQUIPMENT
- SOFTENERS & DEIONIZERS
- RECONDITIONING OF FILTERS & ION EXCHANGERS
- WATER TREATING CONSULTANTS
- BOILER & COOLING WATER CHEMICALS

**SERVICE CONTRACTS**

**(215) 676-1111**

4520 Old Lincoln Hwy.,  
Oakford, PA 19053

## Craftsmanship

**LEE Industries** designs and manufactures the highest quality stainless steel processing vessels and systems for the Pharmaceutical/Bio-Tech, Cosmetic, Food/Beverage and Chemical Industries.

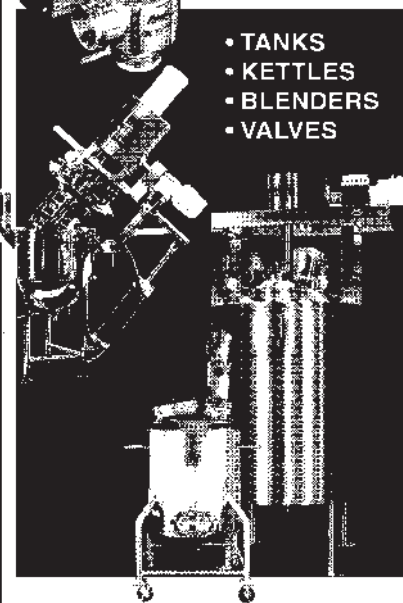

- TANKS
- KETTLES
- BLENDERS
- VALVES

**lee** PROCESS SYSTEMS & EQUIPMENT  
DIVISION OF LEE INDUSTRIES, INC.  
P.O. Box 687 Phillipsburg, PA 16866  
(814) 342-0470 FAX (814) 342-5660  
[www.LEEind.com](http://www.LEEind.com)

Service

## Pharmaceutical Engineering Launches Digital Edition

ISPE is pleased to introduce a new ISPE Member benefit: the digital edition of *Pharmaceutical Engineering* magazine. The inaugural digital issue (January/February 2009) was delivered to the global membership in a browser-based electronic format. In addition to the digital edition, Members will continue to receive the print version.



The digital edition is a flexible electronic version of the magazine that delivers the look and feel of the print edition. It contains all of the content found in the print edition and is easily accessible via the Internet. In addition, the digital edition of *Pharmaceutical Engineering* contains hotlinks to URLs and email addresses that are referenced within articles and advertising so members will gain instant access to additional information and necessary resources.

Members will get all of the features of the *Pharmaceutical Engineering* magazine print edition with the interactive capabilities only available online. Added benefits of the digital edition of *Pharmaceutical Engineering* include:

- Immediate access and timely information
- Access from email link and the Web site
- Faster delivery
- Improved international delivery
- Entire magazine exactly as it appears in print
- High-quality graphics
- Table of Contents links to articles
- Easy-to-use hotlinks to advertiser sites/email capability
- Viewable through your standard Web browser
- Issues can be viewed online or downloaded as a PDF to your desktop
- Print one or more pages from the PDF
- Easy-to-read, searchable format within the issue

Each issue of the *Pharmaceutical Engineering* digital edition will be sent to ISPE Members via a dedicated email just prior to the print editions' publication date. ISPE Members will also be able to access the current digital edition by logging on at [www.ISPE.org/pharmaceuticalengineering](http://www.ISPE.org/pharmaceuticalengineering). 

## ...Japan Affiliate Mission

*Continued from page 66.*

maceutical drugs in the industry; and an improved grasp of the extent to which plant owners challenge new technologies in the quest for excellence.

A highlight of the US experience was the Delaware Valley Chapter-hosted "Welcome Party" on 24 October 2008, organized by Chapter Secretary Shannah Schodle, an ideal social environment where lively exchanges of information took place in a dignified, but relaxed setting.

Conversations during the Chapter evening extended from the professional through to the cultural: visitors from Japan learned World Series baseball chants to support the local Phillies, and US hosts were taught the traditional Japanese synchronized hand-clap close-out of an event, the so-called "san-bon-jime!"

Certainly, a very special relationship was created between US hosts and Japanese guests, and between Chapter/Affiliate.



Members of the Japan Affiliate and ISPE Delaware Valley Chapter end a memorable evening.

Logistics for the entire trip from Japan were provided by an experienced travel agent with chartered buses at US airports for transfers to hotel and plant. A merit of this arrangement was, for example, the ability to quickly move the visitors from Newark hotel to Manhattan for an evening of sightseeing and dining, a much appreciated interlude after a demanding international and domestic travel schedule!

After returning to Japan, Tour Leader Osamu Matsu-moto – the self-styled "Cheerleader" – delivered a summary presentation of the Tour at the Affiliate's Winter Meeting in Yokohama, on 5 December 2008.

Meanwhile, planning is already under way for the Affiliate's 2009 Tour with the focus this year on pharmaceutical-related companies located on the US West Coast, to be followed by participation in the Annual Meeting in San Diego. Hopes are high for an equal level of success in approaching companies to visit, and securing the interest of Japanese membership in participation.

Finally, the Japan Affiliate and its Tour members greatly appreciated the very kind cooperation shown by the US Plants to the visitors from overseas, permitting an unforgettable opportunity to visit their excellent facilities! 

## Argentina

### ***Instructions for Importers and Exporters of Active Raw Material for the Manufacture of Medicinal Products***

The ANMAT agency has published a list of requirements for Importers and Exporters of Active Raw Material aimed at the manufacture of medicinal products. These requirements concern the structure of the premises and the documentation.<sup>1</sup>

### ***Instructions for Obtaining a Manufacturing License for a Medicinal Product***

These instructions list the documents required by the department of inspections of ANMAT when applying for a manufacturing license for a medicinal product.<sup>1</sup> The document also gives instructions in the case of a modification of the manufacturing site inducing a variation of the manufacturing license. These instructions list the relevant guidelines to be complied with according to the type of product manufactured.

## Estonia

### ***GMP***

A new piece of legislation has been published in Estonia regarding GMP.<sup>2</sup> The new act regulates manufacture, handling, distribution, marketing, prescribing, advertising, and authorization of medicinal products (both human and veterinary) and gives the rules for supervision and liability. Among the general information it contains on marketing products, the act also provides guidelines about handling medicinal products by regulating the manufacturing, import/export, trading process, and it establishes legal activities for pharmacies (manufacturing and sale of the medicinal products). The maintenance and transport of the medicinal products, handling of medicinal products that have been eliminated from the market, and the requirements and responsibilities of the Qualified Person are also described in this act.

## Austria

### ***GMP***

A new Decree 324/2008 (named AMBO

2009) has been released by the Austrian Ministry of Health and is aimed to clarify requirements for the manufacturing, the control, the marketing and the advertising of medicinal products by revising and reorganizing the information previously displayed in three different Decrees (479/2004, 434/2005 and 480/2004).<sup>3,4</sup>

AMBO 2009 applies to all companies except public and hospital pharmacies, tissue banks, transfusion establishments, nuclear medicines institutions or laboratories, and entities of the Army.

This decree also regulates the obligations of the companies in terms of good distribution practices and import, authorization and clinical trials, pharmaceutical quality assurance, company organization, premises and equipments, production and quality control, work contracted out, storage, distribution and import, housing of animals intended for the manufacture and the testing of medicinal products, and marketability. It also implements the following EU-Directives: 91/412/EEC, 2001/20/EC, 2001/82/EC, 2003/94/EC and came into force on 1 January 2009.

## Switzerland

### ***Mutual Recognition Agreement on GMP Medicinal Products***

Information has been published on the Mutual Recognition Agreement (MRA) between the European Community (EC) and Swiss Confederation.<sup>5</sup> This MRA in its Annex on medicinal products, GMP inspection, and batch certification includes the provision to cover manufacture of active pharmaceuticals. At the time of implementing the Sectoral Annex, only Switzerland had legal requirements for GMP for Active Pharmaceutical Ingredients (API) in place. Following the review of the EC legislation introducing GMP requirements for APIs discussions between the EC and Switzerland have taken place to include APIs in the operational phase under the current scope of the MRA. With new Community legislation, obligations have been established for finished medicinal product manufacturers to use only active substances

(active pharmaceutical ingredients), which have been manufactured in accordance with GMP (Article 46 (f) of Directive 2001/83/EC and Article 50 (f) of Directive 2001/82/EC; as amended). To fulfill their obligations, manufacturers of medicinal products are expected to audit their API suppliers.

### ***Swissmedic Expands on Existing Multilateral Agreement<sup>6</sup>***

A meeting between the national drug and device authorities of Switzerland (Swissmedic), Australia (Therapeutic Goods Administration), Canada (Health Canada), and Singapore (Health Sciences Authority) has served to intensify the existing collaboration among the countries.<sup>7</sup> The overall aim of the agreement, which applies to both medical devices and pharmaceuticals, is to understand better and build on the processes and systems that other authorities already have in place. The closer cooperation is also aimed at avoiding duplicate procedures in the field of good manufacturing practice. The idea is that where inspections were needed in a third country, for example India or China, these could be undertaken by one of the partner states and the results would then be accepted by the others. In order to promote a better understanding of each other's systems in this area and to build confidence between them, the partner states have also signed up to a personnel exchange program. The agreement involving the four countries goes beyond the relationship that Switzerland has with the European Union.

## Canada

### ***Post-Notice of Compliance Changes: Quality Document***

Health Canada has published the second draft quality guidelines for comment.<sup>8</sup> The objectives of this draft guidance document are:

- to assist with the classification of quality changes made to a new drug that has received a Notice of Compliance (NOC)
- to provide sponsors with recommendations on the data to support

a change which would be considered sufficient to allow a determination of the impact of the change on the quality of the new drug as it relates to safety, efficacy, and/or effective use of the new drug

This guidance document applies to sponsors intending to make changes to new drugs that have received a NOC pursuant to Section C.08.004 of the Food and Drug Regulations. This may include pharmaceuticals, biologics, and radiopharmaceuticals for human use and pharmaceutical, radiopharmaceutical, and certain biotechnological products for veterinary use. This guidance also applies to those submissions for which a NOC has been recommended but issuance of the NOC has been placed on hold. This guidance document should be read in conjunction with the associated Health Canada guidance documents entitled Post-Notice of Compliance (NOC) Changes: Framework and Post-Notice of Compliance (NOC) Changes: Safety and Efficacy as well as other related Health Canada guidance documents.

## Taiwan

### **Registration and Market Approval of Pharmaceuticals – Biosimilars**

A new guideline published by the Taiwanese Health Executive describes the definition of biosimilar drugs and provides guidance for completing market authorisation applications.<sup>9</sup> It describes relevant scientific information, thus helping the industry to verify its claimed similarity. Biosimilar drugs refer to biologics produced by biotechnology, which means to have similar quality, safety, and effectiveness to those innovator biologics that have obtained Marketing Authorizations. Companies developing biosimilars should be subject to the regulations established by the Department of Health, Executive Yuan. The scope of this guideline covers drugs containing recombinant peptides and recombinant proteins as active ingredients and produced by biotechnological means. This guideline does not apply to vaccines, allergenic products, blood or plasma derivatives and their recom-

binant alternatives, and other biologics such as gene or cell-based medicinal products.

### **United States of America Genotoxic and Carcinogenic Impurities**

The U.S. Food and Drug Administration (FDA) has introduced draft guidance for industry entitled “Genotoxic and Carcinogenic Impurities in Drug Substances and Products: Recommended Approaches.”<sup>10</sup> This draft guidance is intended to inform pharmaceutical manufacturers of the agency’s thinking regarding genotoxic and carcinogenic impurities in drug substances and drug products, including biologic products that are regulated by the Center for Drug Evaluation and Research (CDER), and to provide recommendations on how to evaluate the safety of these impurities during clinical development and for marketing applications. This draft guidance, when finalized, will clarify the FDA’s additional testing and exposure threshold recommendations for situations in which genotoxic or carcinogenic impurities are present.

### **More on Genotoxicity and Carcinogenic Impurities**

This guidance is intended to inform pharmaceutical manufacturers of the FDA’s current thinking regarding genotoxic and carcinogenic impurities in drug substances and drug products, including biological products that are regulated by the Center for Drug Evaluation and Research (CDER).<sup>11</sup> This guidance provides recommendations on how to evaluate the safety of these impurities during clinical development (Investigational New Drug Applications (INDs)) and for marketing applications (New Drug Applications (NDAs), Biological License Applications (BLAs), and Abbreviated New Drug Applications (ANDAs)). This guidance provides recommended exposure thresholds on the clinical exposure to genotoxic or carcinogenic impurities. The deadline for comments on this document is 14 February 2009.

## Tunisia

### **Registration Procedures in Tunisia**

The pharmaceutical sector in Tunisia has developed considerably in recent years as a result of the phased implementation of a set of regulations concerning the manufacture, registration, and marketing of medicinal products and the creation of appropriate structures for technical and administrative management, pharmaceutical product controls, and inspections of manufacturing sites.<sup>12-18</sup> Over the past five years, registration procedures have been accelerated, with a particular focus on the approval of innovative products manufactured to high quality standards. The two main bodies involved in these regulatory procedures are the Direction de la Pharmacie (DPM) and the Laboratoire National de Contrôle (LCN). This article also details the requirements for new medicinal products variations and renewals.

## EU – General

### **Pharmaceutical Excipients: Where to Now for GMP?**

GMP is a legal requirement for every component of a medicine, including the active pharmaceutical ingredient and packaging materials, but excipients are currently an exception to that rule. That seems counterintuitive when one considers these ingredients are very often the largest constituent in a medicine by weight. Often the supplier may not even be aware of all the intended uses for its excipient products by its customers.

The regulatory environment for excipients is subject to change in Europe, however, as part of the new legislation amending the existing pharmaceutical law that was introduced in 2005.<sup>19-22</sup> This new legislation requires API manufacture to be performed according to GMP, i.e. the harmonized, International Conference on Harmonization GMP standard ICH/Q7A.<sup>23</sup> Directive 2004/27/EC specifically mandated the implementation of GMP for “certain excipients” including:

- excipients prepared from materials derived from a TSE-relevant animal

species, with the notable exception of lactose

- excipients derived from human/animal material with potential viral contamination risk
- excipients claimed to be sterile (or sold as sterile) and used without further sterilization
- excipients with the specification or claim that they are endotoxin/pyrogen controlled
- specific excipients, namely propylene glycol and glycerol

The article below has been published to provide a brief overview on regulatory trends relating to excipients highlights the difficulties associated with providing an appropriate legal framework for regulating such a fragmented, poorly defined industry.

### **International – US, EU, AU International collaboration on API GMP inspections<sup>24</sup>**

A number of major regulatory bodies have begun testing a more collaborative international approach to good manufacturing practice inspections, aimed at cutting down on duplicative inspection work and making the process more efficient. The project will initially involve only active pharmaceutical ingredients, although if successful it may be extended in future, says a joint statement by the European Medicines Agency (EMA), the U.S. Food and Drug Administration (FDA), and the Australian Therapeutic Goods Administration (TGA).<sup>25</sup>

Under the pilot, which was first announced in July 2008,<sup>26</sup> regulators will share information on inspections at plants manufacturing APIs outside the participating regions. This will allow them to distribute inspection capacity more efficiently, thereby allowing more sites to be monitored and reducing duplicate inspections. Taking part alongside the FDA, the EMA, and the TGA are regulatory agencies from the UK, Germany, France, and Ireland, as well as the European Directorate for the Quality of Medicines and Healthcare (EDQM), which is responsible for the European Pharmacopoeia.

The EMA has a good manufac-

turing practice database, EudraGMP, which in future will allow certain GMP information on inspections performed by European Economic Area member states as well as international partners to be accessible to all interested parties.

### **EU-US (ICH)**

A revision has been made to the Q4B process for Microbiological Examination of Non-Sterile Products: Microbial Enumeration Tests. The proposed texts were submitted by the Pharmacopoeial Discussion Group (PDG). The following ICH documents have been updated:

#### ***Q4B Annex 4A (Step 5)<sup>27</sup>***

Evaluation and recommendation of pharmacopoeial texts for use in the ICH regions on microbiological examination of non-sterile products: microbial enumerations test general chapter Q4B Annex 4A (currently Step 4, date 12/11/2008).

#### ***Update to Q4B Annex 4B (Step 5)<sup>28</sup>***

Evaluation and recommendation of pharmacopoeial texts for use in the ICH regions on microbiological examination of non-sterile products: tests for specified micro-organisms general chapter Q4B 4B (currently Step 4, date 12/11/2008).

#### ***Update to Q4B Annex 4C (Step 5)<sup>29</sup>***

Evaluation and recommendation of pharmacopoeial texts for use in the ICH regions on microbial examinations of non-sterile products: acceptance criteria for pharmaceutical preparations and substances for pharmaceutical use general chapter Q4B 4C (currently Step 4, date 12/11/2008).

#### ***Update on Q4B Annex 6<sup>30</sup>***

Draft Consensus guideline evaluation and recommendation of pharmacopoeial texts for use in the ICH regions on uniformity of dosage units general chapter Q4B Annex 6 (current step 2, date 13/11/2008).

#### ***Update on Q4B Annex 7<sup>31</sup>***

Evaluation and recommendation of

pharmacopoeial texts for use in the ICH region on dissolution test general chapter Q4B Annex 7 (current step 2, date 13/11/2008).

#### ***Update on Q4B Annex 8<sup>32</sup>***

Evaluation and recommendation of pharmacopoeial texts for use in the ICH region on sterility test general chapter Q4B Annex 8 (current step 2, dated 13/11/2008).

The following meetings were held during the period covered by this update:

- The Committee for Orphan Medicinal Products (COMP) held its ninety-sixth plenary meeting on 9 to 10 December 2008.<sup>33</sup>
- The Committee for Medicinal Products for Human Use (CHMP) held its December plenary meeting from 15 to 18 December 2008.<sup>34</sup>
- The Committee for Medicinal Products for Human Use (CHMP) held its January plenary meeting from 19 to 22 January 2009.<sup>35</sup>
- The Committee for Orphan Medicinal Products (COMP) held its ninety-seventh plenary meeting on 7 January 2009.<sup>36</sup>

### **References**

1. www.anmat.gov.ar
2. Act No. 391 of 18 December 2008.
3. Bundesgesetzblatt, Legislation, Official Journal, www.digitalegesetze.at
4. Bundesgesetzblatt, Teil II, Nr. 324/2008 vom 17 September 2008, came into force 1 January 2009.
5. EC – Switzerland MRA Sectoral Annex on GMP medicinal products GMP inspection and batch certification Doc. Ref. EMA/INS/MRA/622138/2008 (6 November 2008).
6. RAJ Pharma, Vol. 20, No. 2, February 2009.
7. Swissmedic press release, 10 December 2008, www.swissmedic.ch/cgi/news/index.asp?sitetype=laien&news\_id=5393
8. Health Canada: Second Draft guidance Document – Post notice of Compliance Changes (Dated 2/12/2008).

9. Review Criteria for Registration and Market Approval of Pharmaceuticals-Registration and Market Approval of Biological Products DAD-0970333017 (Department of Health Executive, Taiwan ROC).
10. Draft Guidance for Industry on Genotoxic and Carcinogenic Impurities in Drug Substances and Products: Recommended Approaches; Availability. [Docket No. FDA-2008-D-0629] Federal Register: 16 December 2008 (Volume 73, Number 242) (Pages 76361 – 76362).
11. Guidance for Industry – Genotoxic and Carcinogenic Impurities in Drug Substances and Products: Recommended Approaches (Draft) – December 2008.
12. RAJ Pharma Journal issue: Vol. 19, No. 12, December 2008.
13. Loi Nr 85-91 du 22 Novembre 1985 réglementant la fabrication et l'enregistrement des médicament destinés à la médecine humaine, www.dpm.tn
14. Arrêté du Ministre de la Santé Publique du 10 Septembre 1996 fixant les modalités d'octroi d'une autorisation de mise sur le marché de médicament à usage humain, son renouvellement et sa cession, www.dpm.tn
15. Arrêté du Ministre de la Santé Publique du 15 Octobre 2002 fixant la composition et le fonctionnement du comité technique des spécialités pharmaceutiques, en vue de l'autorisation de mise sur le marché, www.dpm.tn
16. Circulaire Nr 41/95 portant création d'une cellule de suivi relative à la commercialisation des médicaments, 26 Avril 1995, www.dpm.tn
17. Circulaire Nr 80 relative à l'origine des médicaments, 31 Août 1995, www.dpm.tn
18. Guidelines on registration procedures, www.dpm.tn
19. RAJ Pharma, Vol. 19, No. 12, December 2008.
20. Directive 2004/27/EC amending Directive 2001/83/EC on medicinal products for human use, *OJ*, 2004, L136, 34-57, [http://ec.europa.eu/enterprise/pharmaceuticals/eudralex/vol-1/dir\\_2004\\_27/dir\\_2004\\_27\\_en.pdf](http://ec.europa.eu/enterprise/pharmaceuticals/eudralex/vol-1/dir_2004_27/dir_2004_27_en.pdf)
21. Directive 2004/24/EC amending, as regards traditional herbal medicinal products, Directive 2001/83/EC on medicinal products for human use, *OJ*, 2004, L136, 85-90, [http://ec.europa.eu/enterprise/pharmaceuticals/eudralex/vol-1/dir\\_2004\\_24/dir\\_2004\\_24\\_en.pdf](http://ec.europa.eu/enterprise/pharmaceuticals/eudralex/vol-1/dir_2004_24/dir_2004_24_en.pdf)
22. Regulation (EC) 726/2004 on medicinal products for human and veterinary use and the European Medicines Agency, *OJ*, 2004, L136, 1-33, [http://ec.europa.eu/enterprise/pharmaceuticals/eudralex/vol-1/reg\\_2004\\_726/reg\\_2004\\_726\\_en.pdf](http://ec.europa.eu/enterprise/pharmaceuticals/eudralex/vol-1/reg_2004_726/reg_2004_726_en.pdf)
23. Good Manufacturing Practice Guide for Active Pharmaceutical Ingredients Q7 (previously coded Q7A), September 2001, [www.ich.org/LOB/media/MEDIA433.pdf](http://www.ich.org/LOB/media/MEDIA433.pdf)
24. RAJ Pharma Journal issue: Vol. 20, No. 2, February 2009.
25. Joint release, EMEA, FDA and TGA, 8 January 2009, [www.emea.europa.eu/Inspections/docs/43043807enrev1.pdf](http://www.emea.europa.eu/Inspections/docs/43043807enrev1.pdf)
26. The Regulatory Affairs Journal – Pharma, 2008, 19(8), 536-537.
27. <http://www.ich.org/LOB/media/MEDIA4920.pdf>
28. <http://www.ich.org/LOB/media/MEDIA4921.pdf>
29. <http://www.ich.org/LOB/media/MEDIA4922.pdf>
30. <http://www.ich.org/LOB/media/MEDIA4923.pdf>
31. <http://www.ich.org/LOB/media/MEDIA4924.pdf>
32. <http://www.ich.org/LOB/media/MEDIA4925.pdf>
33. <http://www.emea.europa.eu/pdfs/human/comp/pr/66678508en.pdf>
34. <http://www.emea.europa.eu/pdfs/human/press/pr/67072408en.pdf>
35. <http://www.emea.europa.eu/pdfs/human/press/pr/3966009en.pdf>
36. <http://www.emea.europa.eu/pdfs/human/comp/pr/69410709en.pdf>

*This information was provided by Frank Sayala, Pharmaceutical Research Associates (UK).* 



The Global Information Source for Pharmaceutical Science and Manufacturing Professionals

# PHARMACEUTICAL ENGINEERING®

THE OFFICIAL  
MAGAZINE OF  
ISPE

MARCH/APRIL 2009 VOLUME 29, NUMBER 2



**PAT and Green Chemistry**

**PAT Data Management Solutions**

**Freeze-Drying Process Technology**

**Operational Excellence**

**Rapid Deployment**

**ISPE Japan Affiliate Tours US Pharma Companies**

**2009 FOYA Category Winners Announced**

*Pharmaceutical Engineering*

*Launches Digital Edition*

Official sponsor of:

ENGINEERING PHARMACEUTICAL INNOVATION

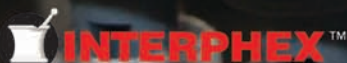

[www.ISPE.org](http://www.ISPE.org)

# Dust Problem?

Go to where dust and fume pollution meet permanent solutions.

[www.pharmadustcollectors.com](http://www.pharmadustcollectors.com)



We make the toughest, best-built industrial dust collectors in the industry!

Visit [www.farrapc.com](http://www.farrapc.com) today.

**FARR**  
Air Pollution Control

We make the toughest, best-built industrial dust collectors in the industry!

Home About Us Products Applications Contact Us

Gold Series®  
Customer Installation Photos  
Case Studies  
Who's Using Farr  
Testimonials  
Industry Articles  
Product Awards

Download Capabilities Brochure

**Gold Series® Camtain®**  
The dust collector designed specifically for pharmaceutical and containment applications.

**Processes Involving Pharmaceutical Dust**

**Gold Series Camtain on Pharmaceutical Manufacturing Applications**

- The Gold Series (GS) Camtain units can be used in a variety of pharmaceutical dust collection applications including tablet presses, coating, fluid bed drying, spray drying, blending, granulation and general room ventilation.
- The GS Camtain is perfect for high efficiency filtration where recovery of the product is not required.
- Safe-change containment systems are available for both the filter cartridges and discharge system underneath the collector. The discharge change utilizes the bag-in/bag-out (BIBO) method while the discharge uses continuous liner technology.
- The GS Camtain can also support traditional dust collection for nuisance dusts and fumes that do not require full isolation and containment.

Download Gold Series on Pharmaceutical Brochure

Benefits  
Health Safety Co  
Equipment O  
Proper Ap  
Users a  
Farr



**FARR**

*Air Pollution Control*



Farr APC is a proud member of the Camfil Farr Group.  
Visit [www.camfilfarrapc.com](http://www.camfilfarrapc.com) for offices out of North America.

**866-530-5474**

Jonesboro, AR • email: [filterman@farrapc.com](mailto:filterman@farrapc.com)



We'll give your  
CFO a reason  
to smile.

*Adding value to enhance your bottom line.*

CRB is a global provider of end-to-end solutions for life science and advanced technology companies. Our solutions deliver enhanced value, productivity and return on investment. Whether you are across town or across the pond, CRB's consulting, design and construction expertise will meet your R&D and manufacturing needs, while adding some black to your bottom line.

1.877.4CRBUSA  
[crbusa.com/ROI](http://crbusa.com/ROI)



Consulting

Design

Construction

Commissioning

Qualifications

## EDITORIAL STAFF

### Publications

**Editor and Director of Publications**  
Gloria N. Hall  
**Publications Manager**  
Lynda D. Goldbach  
**Technical Writer**  
Rochelle Runas  
**Publications Coordinator**  
Amy Leccardone

### Sales

**Director of International Sales**  
David J. Hall  
**Sales Coordinator**  
Valerie Adams  
**European Sales Manager**  
Christine Sainvil

### PHARMACEUTICAL ENGINEERING®

(ISSN: 0273-8139) is published bimonthly by ISPE, 3109 W. Dr. Martin Luther King Jr. Blvd., Suite 250, Tampa, Florida 33607, USA. Telephone +1-813-960-2105. Fax +1-813-264-2816. Periodicals postage paid at Tampa, Florida, USA.



### Subscriptions.

An annual subscription to PHARMACEUTICAL ENGINEERING is included in the membership of ISPE. Any reproduction of the contents of this publication in whole or part is strictly forbidden without the written permission of ISPE. Views and conclusions expressed in articles herein are those of the authors and not necessarily those of the editorial staff, officials and Board of Directors of ISPE.

### US Postmaster:

send change of address to Pharmaceutical Engineering, 3109 W. Dr. Martin Luther King Jr. Blvd., Suite 250, Tampa, Florida 33607.

### Canada Postmaster:

send change of address information and blocks of undeliverable copies to PO Box 1051, Fort Erie, ON L2A 6C7. Canada Post Agreement Number 40041350.

©2009 International Society for Pharmaceutical Engineering. Pharmaceutical Engineering and the logo appearing throughout this magazine are registered trademarks.

### ISPE HEADQUARTERS

3109 W. Dr. Martin Luther King Jr. Blvd. Suite 250  
Tampa, Florida 33607 USA  
Tel +1-813-960-2105  
Fax +1-813-264-2816

### ISPE ASIA PACIFIC OFFICE

73 Bukit Timah Road  
#04-01 Rex House  
Singapore 229832  
Tel +65-6496-5502  
Fax +65-6336-6449

### ISPE CHINA OFFICE

Suite 2302, Wise Logic International Center  
No. 66 North Shan Xi Road  
Shanghai 200041, China  
Tel +86-21-5116-0265  
Fax +86-21-5116-0260

### ISPE EUROPEAN OFFICE

Avenue de Tervueren, 300  
1150 Brussels, Belgium  
Tel +32-2-743-4422  
Fax +32-2-743-1550

[www.ISPE.org](http://www.ISPE.org)



The Global Information Source for Pharmaceutical Science and Manufacturing Professionals

# PHARMACEUTICAL ENGINEERING®

THE OFFICIAL  
MAGAZINE OF  
ISPE

MARCH/APRIL 2009 VOLUME 29, NUMBER 2

## ISPE Board of Directors

### Officers

**Chair, Charles P. Hoiberg, PhD, Pfizer**  
**Vice Chair, Alan Mac Neice, Elan Corp.**  
**Treasurer, Andre L. Walker, CPIP, Biogen/Idex Manufacturing ApS.**  
**Secretary, Arthur D. (Randy) Perez, PhD, Novartis Pharmaceuticals Corp.**

### Directors

**Nuala F. Cainan, PM Group**  
**Bruce S. Davis, Global Consulting (Immediate Past Chair)**  
**Charlotte Enghave, PhD, NNE Pharmaplan**  
**Nigel Frost, Thermal Transfer Ltd.**  
**Joan L. Gore, RPh, Eli Lilly and Co.**  
**Damian J. Greene, Pfizer Inc.**  
**Tomiyasu Hirachi, EEM Japan Co., Ltd.**  
**David E. Petko, PE, Auxilium Pharmaceuticals Inc.**  
**Stephen M. Tyler, Abbott Laboratories**  
**Stephanie A. Wilkins, PE, PharmaConsult US Inc.**  
**Dr. Guy A.S. Wingate, GlaxoSmithKline**

## ISPE Pharmaceutical Engineering Committee and Reviewers

**Chair, Phillip V. Pursifull, Commissioning Agents, Inc.**  
**Co-Chair, Judith S. Samardelis, Wyeth BioTech**  
**Janice T. Abel, ARC Research Group**  
**Jan S. Baldauf, Environmental Resources Management**  
**Stephen Bryan, AstraZeneca**  
**Nissan Cohen, Start-Up Business Development**  
**Rajesh V. Dave, Wyeth**  
**Charlotte Enghave, PhD, NNE Pharmaplan**  
**Jeff Hargroves, ProPharma Group Inc.**  
**James B. Hills, Sanofi-Aventis**  
**Barbara J. Lanman, Roche Diagnostics Operations Inc.**  
**Catherine E. Middelberg, Wyeth Biotech**  
**James M. O'Brien, NAMA Industries Inc.**  
**Miguel A. Perez Colon, Water Management Associates**  
**Dr. Johannes Rauschnabel, PhD, Robert Bosch GmbH**  
**Murray A. Sterling, Precis Engineering Inc.**  
**Stephanie A. Wilkins, PE, PharmaConsult US Inc.**  
**Steven J. Wisniewski, IPS**

## Editorial Reviewers

**Rory Budihandjojo, Boehringer Ingelheim**  
**Jose A. Caraballo, Amgen Manufacturing Ltd.**  
**John T. Connor, Telstar North America**  
**Robert Del Ciello, PE, Northshire Associates**  
**Dr. Thomas C. Dine, Dine Consultancy Ltd.**  
**Martin Dübblin, Y-Tec GmbH**  
**Ronald C. Gaughf, Eli Lilly & Co. (retired)**  
**Mervyn L. Hamer, Intercell USA**  
**Orlando Lopez, Alpha Integrated Solutions**  
**Joseph J. Manfredi, GMP Systems, Inc.**  
**Hank Moes, Arion Water Inc. (retired)**  
**Philippe Robin, Jacobs France**  
**Andrzej J. Szarmanski, Polpharma SA**  
**Takeshi Takashima, Powrex Corp.**  
**Richard S. Tessier, PE, Novartis Pharmaceuticals Corp.**  
**Dr. Slawomir Wielinski, GlaxoSmithKline Pharma SA**  
**Bruce R. Williams, Williams Process Ltd.**

## ISPE Professional Staff

### CORPORATE

**President/Chief Executive Officer, Robert P. Best**  
**Professional Advisors**  
**International Regulatory Affairs Advisor, Douglas I. Ellsworth**  
**European Regulatory Affairs Advisor, John Berridge**  
**Asia-Pacific Regulatory Affairs Advisor, Robert W. Tribe**  
**University Relations Advisor, Jon S. Tomson**  
**Technical Documents Writer/Editor, Gail Evans**  
**Regulatory Web Site Consultant, Eileen Junker**  
**Technical Documents Advisor, Russell Madsen**  
**European Education Advisor, Dr. Kate E. McCormick**  
**North American Education Advisor, Jeffery N. Odum**  
**POLI Technical Project Manager, Chris Potter**  
**Technical Consultant, Sion Wyn**

### NORTH AMERICA

#### ADMINISTRATION

**Vice President of Administration/CFO, Victoria Smoke**  
**Administrative Coordinator, Debbie Miller**

#### Accounting

**Director of Accounting, Alicia Aponte**  
**Accounting Manager, Meredith Pritchett**  
**Accounting Coordinators**  
Julie Amburn  
Coleen Fisher  
Shirley Noble

#### Event Operations

**Director of Event Operations, Kindra Bess**  
**Event Operations Coordinator, Danielle Shelton**

#### Information Systems

**Director of Information Systems, Chris Muratore**  
**Application Needs Analyst, Roberto Diaz-Viana**  
**Help Desk Technician, Michael Shelp**

#### Human Resources

**Director of Human Resources, Trudy Contessa**  
**Compensation and Benefits Coordinator, Holly Smith**

#### International Sales

**Director of International Sales, David J. Hall**  
**Sales Coordinator, Valerie Adams**

#### KNOWLEDGE MANAGEMENT

##### Continuing Education

**Director of Continuing Education, Virginia (Ginger) Phillips**  
**Continuing Education Coordinator, Lisa Steward**  
**Continuing Education and Training Coordinator, Malika Hamm**

##### Knowledge Management

**Director of Knowledge Management, Carol Winfield**  
**Web Site Technical Specialist, Chris Grab**  
**Web Site Project Manager, Melanie Woods**  
**Web Site Associate, Kathleen McKinnon**

#### Publications

**Editor and Director of Publications, Gloria N. Hall**  
**Publications Manager, Lynda D. Goldbach**  
**Technical Writer, Rochelle Runas**  
**Publications Coordinator, Amy Leccardone**

#### Regulatory Affairs

**Regulatory Affairs Specialist, Gina Chan**

#### Technology-Based Learning

**Technology-Based Learning Manager, Rae Hayward**  
**Technology-Based Learning Coordinator, Connie Garcia**

#### Training

**Director of Training, Alicia Montes**  
**Training Program Coordinator, Jessica Bradley**

## MEMBER RELATIONS

**Vice President of Member Relations, Karleen Kos**  
**Affiliate and Chapter Relations**  
**Director of Affiliate and Chapter Relations, Lynne Richards**  
**Affiliate and Chapter Relations Coordinator, Tracey Ryan**  
**Business Initiatives**  
**Director of Business Initiatives, Scott Ludlum**  
**Business Initiatives Administrative Assistant, Cicelle Domingo**  
**COP Coordinator, Jacqueline Saldana**  
**Member Services**  
**Director of Member Services, Christian DeSouza**  
**Member Services Manager, Alain Vandamme**  
**Member Services Coordinators**

Patricia Hill  
Xuandi Hoang  
Fred Jimenez  
Diane Lakner  
Maria Mendoza  
**Shipping/Fulfillment Coordinator, Cindy Dowdy**  
**Shipping/Fulfillment Assistant, Mark Bunker**

### Membership Development

**Director of Membership Development, Linda Brady, CAE**  
**Membership Development Coordinator, Angela Brumley**

### Professional Certification

**Director of Professional Certification, Jerry J. Roth**  
**Professional Certification Coordinator, Katherine Cebollero**

## MARKETING COMMUNICATIONS

**Director of Marketing Communications, Alison Matherly**  
**Communications Manager, Marni Schribman**  
**Marketing Communications Associates**  
Heather Fortson  
Sarah McConnell  
**Communications Coordinator, Elizabeth Pierre-Saint**  
**Traffic Coordinator, Lisa Maccaroni**  
**Graphic Designer, Karelina Lopez**

## EUROPE

**Vice President of European Operations, Paul K. Jordan**  
**European Operations Director, Elmarie Herloff-Petersen**  
**Member Relations**  
**European Sales Manager, Christine Sainvil**  
**European Member/Affiliate Relations Manager, Marie Hélène Charles**

**European Services Coordinator, Francesca Rollo**

### Events/Conferences

**European Conference Manager, Michela Melis**  
**European Education Program Manager, Eralda Azizaj**  
**European Event Logistics Administrator, Dorothy Henry**  
**European Event Logistics Coordinator, Emma Boyd**  
**European Education Program Coordinator, Laura La Porta**

### Operations

**European Customer Service Coordinator (Membership), Evariste Biyege**

### Marketing Communications

**European Marketing Manager, Claudia Fortes**  
**European Marketing Coordinator, Hanna Kuikka**  
**European Web Site Coordinator, Vicky Laurijssen**

## ASIA PACIFIC

**Asia Pacific Operations Manager, Chester Chu**  
**Asia Pacific Affiliate Relations Manager, Rhonda Ng**  
**Asia Pacific Customer Service Coordinator, Dex Wah**  
**Asia Pacific Marketing Communications Manager, Sharon Lim**

## CHINA

**China Membership and Affiliate Relations Manager, Cheryl Siow**  
**China Event Manager, Sarah Xiao**  
**China Customer Relations Coordinator, Danni Cao**  
**China Sales Associate, Jackie Liu**

# PARSONS

Integrated Solutions for the Global Life Sciences Industry

Engineering, Architecture, Procurement,  
Program and Construction Management, Validation

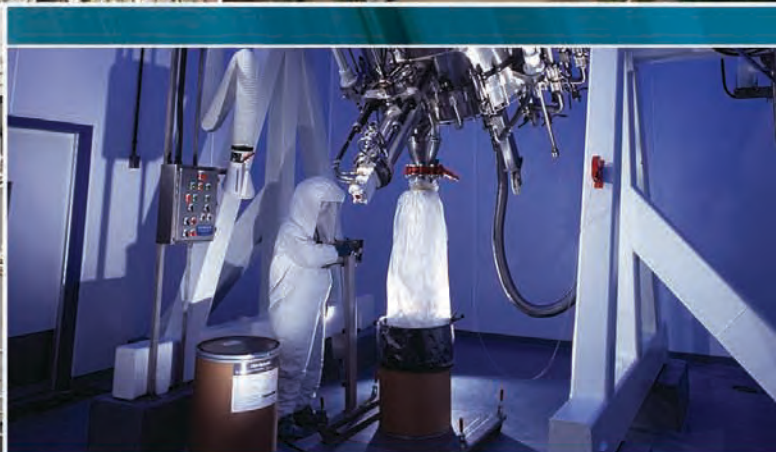
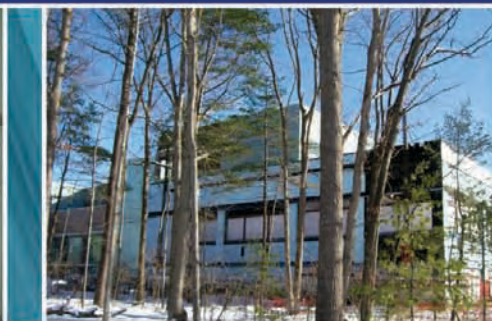

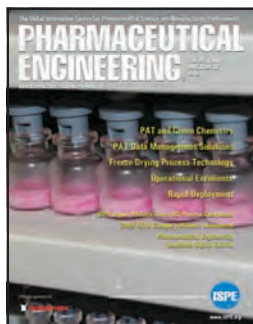

The Global Information Source for Pharmaceutical Science and Manufacturing Professionals

# PHARMACEUTICAL ENGINEERING®

THE OFFICIAL MAGAZINE OF ISPE

MARCH/APRIL 2009 VOLUME 29, NUMBER 2

## Cover Photo

Courtesy of  
GlaxoSmithKline  
Biologicals.

## Cover Design

Lynda Goldbach, ISPE  
Publications Manager

## Current Issue/Theme

MARCH/APRIL 2009  
*Automation Solutions/  
PAT/Operational  
Excellence*

## Next Issue/Theme

MAY/JUNE 2009  
*Regulatory - PQLI*  
Publishes 22 May 2009

## Articles

- 8 **PAT and Green Chemistry: The Intersection of Benign by Design and Quality by Design**  
by Dr. Berkeley W. Cue, Dr. John Berridge, and Julie B. Manley
- 22 **Introduction to PAT Data Management Solutions**  
by Mark N. Reed
- 36 **Considerations for Transferring a Bulk Freeze-Drying Process from a Glass Container to a Tray**  
by Yves Mayeresse, Vinciane de Cupere, Romain Veillon, and Joseph Brendle
- 48 **Clinical Manufacturing Efficiency**  
by Beth H. Junker, Kay Hunsberger, Vicky Griffin, Kent Hamaker, Carl Holz, Amy Caparoni, Kelly Kistler, Jeffrey Graczyk, and Marshall Gayton

- 60 **Using GAMP 5 for Rapid Deployment**  
by Markus Roemer and Hermann Schaefer

## Departments

- 66 **ISPE Update**  
ISPE Japan Affiliate Tours US Pharmaceutical Companies  
2009 Facility of the Year Awards (FOYA) Category Winners Announced  
*Pharmaceutical Engineering* Launches Digital Edition
- 68 **Classified Advertising**
- 69 **Advertiser's Index**

## On-Line Exclusive Articles

### Global Regulatory News

visit [www.ISPE.org/PharmaceuticalEngineering](http://www.ISPE.org/PharmaceuticalEngineering)





This article will illustrate the application of Process Analytical Technology (PAT) as an important contributor to the “triple bottom line,” a measure of a company’s economic, environmental, and social performance, and the sustainability of the pharmaceutical industry.

# PAT and Green Chemistry: The Intersection of Benign by Design and Quality by Design

by Dr. Berkeley W. Cue, Dr. John Berridge, and Julie B. Manley

The pharmaceutical industry continues to face challenges such as rising healthcare costs, changing regulatory requirements, and developing the product pipeline. Mechanisms to increase efficiency through the introduction of new technology early in the development process are being demonstrated to improve manufacturing efficiency with an impact on the financial bottom line. More pharmaceutical companies are turning to green chemistry and its 12 principles for waste reduction as a new focus for cost containment. Process Analytical Technology (PAT) plays an important role in green chemistry, and as a result, it has a positive impact on the “triple bottom line” – a measure of a company’s economic, environmental, and social performance. Therefore, process understanding and the application of PAT early in process development are important to the sustainability of the pharmaceutical industry. PAT has heretofore been recognized for its value to product quality and efficient production. This discussion will illustrate the environmental and social benefits of PAT, demonstrating that the application of PAT is an important contributor to the “triple bottom line,” performance of a company, and the sustainability of the pharmaceutical industry.

## Introduction

Why should the pharmaceutical industry be interested in green chemistry? Simply stated, it is an important “how” in the how to become a sustainable company and a sustainable industry. The mission of the pharmaceutical industry, “pharmaceutical companies are devoted to discovering and developing new medicines that will enable patients to live longer, healthier, and more productive lives,”<sup>1</sup>

is among the noblest missions any industry can undertake. However, without a commitment to a healthy environment, this industry’s mission is incomplete. Like all industries that use chemistry to produce the products that are the life blood of its sustainability, the pharmaceutical industry produces waste as part of the manufacture of the medicines it sells. It has been reported<sup>2</sup> that on average, only one percent of the raw materials extracted from the earth to manufacture all finished product consumed on our planet end up in the final product; the remaining 99% becomes waste. This analysis is based on the current consumption, primarily in the western nations and Japan. As the economies of the third world, especially China and India, where 40% of our planet’s population resides, begin to acquire the goods and services typical of western middle class consumption, estimates suggest the resources of three to four planet Earths will be required to provide all the raw materials needed if utilization efficiencies do not improve.<sup>3</sup>

The pharmaceutical industry’s manufacturing waste metrics are worse than those reported above. A study published by Sheldon<sup>4</sup> in 1994 showed that among the major chemical industry sectors (oil refining, bulk chemicals, fine chemicals, and pharmaceuticals) pharmaceutical manufacturing generated the most waste per unit of product—between 25 kg (55 lb) and 100 kg (220 lb) or more of waste per kilogram (2.2 lb) of Active Pharmaceutical Ingredient (API) produced - *Table A*, and these numbers only reflect the use of advanced intermediates as starting points. This performance metric, called an E-Factor, has been rationalized at various times by the relative length of the syntheses, the complexity of the target molecules, the

*Continued on page 10.*



# DeltaV Batch.

## The perfect cup. Every time.



### Easy.

Emerson understands your need to quickly respond to varying customer requirements. That's why we designed DeltaV Batch to give you the robust, repeatable performance that lets you assure your customers of a perfect, on-spec batch. First time. Every time. Easy.

From seamless integration with your enterprise planning and manufacturing execution systems to modular, class-based configuration and integrated change management, DeltaV Batch simplifies your batch operations.

Enabling agile manufacturing has never been easier. So, grab yourself a fresh cup and visit: [EasyDeltaV.com/Batch](http://EasyDeltaV.com/Batch)



The Emerson logo is a trademark and a service mark of Emerson Electric Co. ©2008 Emerson Electric Company



**EMERSON. CONSIDER IT SOLVED.™**

Industry Sector	Product Tonnage	kg Byproducts/ kg of Product (E-factors)
Oil refining	106 – 108	ca 0.1
Bulk Chemicals	104 – 106	< 15
Fine Chemicals	102 – 104	5-50
Pharmaceuticals	101 – 103	25-100+

Table A. E-Factor for sectors of the chemical industry by quantity of byproduct per kg of product.

batch nature of pharmaceutical manufacture, and even by the low volumes of product compared to say, bulk chemicals. While there have been some notable successes in reducing E-Factors for selected drugs, based on the limited reports to date, not much progress has been made in lowering these waste metrics industry wide.

A benchmarking study made public in 2007 by the American Chemical Society (ACS) Green Chemistry Institute (GCI) Pharmaceutical Roundtable suggests that the E-Factor Sheldon identified for the pharmaceutical industry is fairly consistent with current industrial data. The Roundtable is a partnership between the ACS GCI® and member pharmaceutical companies dedicated to the integration of green chemistry and green engineering in the global pharmaceutical industry. The Roundtable decided to focus on Process Mass Intensity (PMI), somewhat different than the E-Factor in that it focuses on the amount of material used in a process rather than the waste generated. However, the median PMI for processes in this study representing seven major pharmaceutical companies was 120 kg (264 lb) material used/kg API.<sup>5</sup> The study also concluded that solvent was the major contributor to PMI. A recent publication analyzing API lifecycles by GSK scientists<sup>6</sup> indicates that most of the waste (approximately 80%) is solvent related with the remainder being solids. This finding suggests the biggest impact on waste volume reduction can be achieved by focusing on solvents and solvent utilization. Green chemistry is the tool that enables this.

## What is Green Chemistry?

Green chemistry has been defined by Anastas and Warner<sup>7</sup> as the utilization of a set of principles that reduces or eliminates the use or generation of hazardous substances in the design, manufacture, and application of chemical products. They described a set of 12 principles that were based on best practices for waste reduction and waste avoidance.

Green chemistry has become so powerful at redefining how molecules and the processes to make them can be designed to minimize hazardous waste that the US Environmental Protection Agency (EPA) has created the Presidential Green Chemistry Challenge<sup>8</sup> and awards best practices each year based on five focus areas. Through 2008, winners have achieved the following results annually: eliminated 193 million pounds (87,500 mt) of hazardous chemicals and solvents – enough to fill an 11-mile long train; saved 57 million pounds (26,000 mt) of carbon dioxide – equal to taking 6,000 automobiles off the road; eliminated 21 billion pounds (9.5M mt) of water – enough to meet the annual needs of 820,000 people, Winners

and nominees annually are saving one billion pounds (453,000 mt) of hazardous chemicals and solvents from the products and processes we use every day.<sup>9</sup>

## Why Should the Pharmaceutical Industry be Interested in Green Chemistry?

Among the pharmaceutical companies winning this EPA recognition are Boots Health Care in 1997 for the redesign of the ibuprofen process; Lilly in 1999 for improvements in the talampanol process; Roche Colorado Corporation for substantial improvements to its ganciclovir process; Pfizer in 2002 for the redesign of its process to make sertraline hydrochloride; BMS in 2004 for replacing a semi synthetic process to paclitaxel, the API in Taxol, with a process based on plant cell fermentation; and Merck in 2005 and 2006 for

<b>1. Prevention</b> It is better to prevent waste than to treat or clean up waste after it has been created.
<b>2. Atom Economy</b> Synthetic methods should be designed to maximize the incorporation of all materials used in the process into the final product.
<b>3. Less Hazardous Chemical Syntheses</b> Wherever practicable, synthetic methods should be designed to use and generate substances that possess little or no toxicity to human health and the environment.
<b>4. Designing Safer Chemicals</b> Chemical products should be designed to effect their desired function while minimizing their toxicity.
<b>5. Safer Solvents and Auxiliaries</b> The use of auxiliary substances (e.g., solvents, separation agents, etc.) should be made unnecessary wherever possible and innocuous when used.
<b>6. Design for Energy Efficiency</b> Energy requirements of chemical processes should be recognized for their environmental and economic impacts and should be minimized. If possible, synthetic methods should be conducted at ambient temperature and pressure.
<b>7. Use of Renewable Feedstocks</b> A raw material or feedstock should be renewable rather than depleting whenever technically and economically practicable.
<b>8. Reduce Derivatives</b> Unnecessary derivatization (use of blocking groups, protection/deprotection, temporary modification of physical/chemical processes) should be minimized or avoided if possible, because such steps require additional reagents and can generate waste.
<b>9. Catalysis</b> Catalytic reagents (as selective as possible) are superior to stoichiometric reagents.
<b>10. Design for Degradation</b> Chemical products should be designed so that at the end of their function they break down into innocuous degradation products and do not persist in the environment.
<b>11. Real-time Analysis for Pollution Prevention</b> Analytical methodologies need to be further developed to allow for real-time, in-process monitoring and control prior to the formation of hazardous substances.
<b>12. Inherently Safer Chemistry for Accident Prevention</b> Substances and the form of a substance used in a chemical process should be chosen to minimize the potential for chemical accidents, including releases, explosions, and fires.

Table B. The 12 Principles of Green Chemistry.

*Continued on page 12.*

# ARE YOU RELYING ON SAFETY PRODUCTS THAT **"SHOULD"** WORK?

**FIKE IS COMMITTED TO RELIABLE SAFETY SOLUTIONS THROUGH  
RESEARCH, NEW TECHNOLOGIES, AND EXTENSIVE TESTING.**

## EXPLOSION PROTECTION • PRESSURE RELIEF • TESTING SERVICES

- Comprehensive selection of ASME, CE and 3-A rupture/bursting discs
- High performance explosion vents, specifically designed for sanitary applications
- Complete line of products designed for CIP/SIP applications
- Dedicated Team of Combustion Engineers and Pressure Relief Experts

**DON'T LEAVE THE SAFETY OF YOUR BUSINESS TO ANYTHING LESS  
THAN THE MOST RELIABLE, PROVEN PRODUCTS.**



EXPLOSION  
VENTING



EXPLOSION  
SUPPRESSION



RUPTURE  
DISCS



FULL-SCALE  
TESTING

# Fike®

[WWW.FIKE.COM](http://WWW.FIKE.COM)

**PROVEN PERFORMANCE, QUALITY AND RELIABILITY FOR OVER 60 YEARS**

Visit us at Interphex NYC, Booth #1360

**1-866-758-6004**

reducing the environmental footprint of its aprepitant (for Emend) and sitagliptin (for Januvia) processes by almost ten-fold, respectively. Merck reported an estimated annual savings of \$14 million per year from the improved process for imipenem (Primaxin).<sup>10</sup> Roche Ireland, Ltd. won a Cleaner Technologies Award sponsored by the Irish Business and Employers Confederation for its process changes to mycophenolate mofetil (MMF), the active ingredient in the Cellcept immune-system suppressant given to transplant patients to prevent rejection of a new organ. Roche reported recouping its \$1 million investment in MMF in one year.<sup>11</sup> While this list is not a comprehensive summary, it is still impressive, yet it represents just a small fraction of the APIs that are manufactured every year to support a global drug industry generating more than \$700 billion in sales in 2007.<sup>12</sup>

How much waste is produced by the pharmaceutical industry? It is not possible to know the amount precisely, but an estimate can be made from the annual sales and some assumptions about average dose and daily selling price as well as using Sheldon's E-Factor ranges. Thus, calculations suggest that as much as three billion kilograms (6.6 billion lb) of waste could be co-produced in the manufacture of the API that is contained in the medicines sold. And, as the large patient populations in the third world start getting access to these medicines, the total waste footprint of this industry will increase dramatically, unless a significant improvement in the environmental profile of each process is achieved. Using E-Factors reported for the green chemistry award winning processes, the total waste profile could be reduced as much as 75% or more.<sup>13</sup> This waste represents a double economic penalty to the industry. Purchased chemicals that do not end up in the API represent lost opportunity costs as well as the regulatory costs associated with disposing of the waste byproducts and solvents. Given the pressure this industry is under to address and reduce its manufacturing costs makes green chemistry a business imperative going forward.

## How are Quality by Design (QbD) and Benign by Design (BbD) Related?

It has long been recognized that QbD offers significant advantages in the reduction of waste<sup>14</sup> and hence the creation of more benign processes. In advocating the implementation of QbD principles, the FDA cites waste reduction as one of the many industry benefits.<sup>15</sup> The tie in of PAT with green chemistry comes from principles six and 11: real-time analysis further developed to allow for real-time, in-process monitoring and control to maximize energy efficiency and to reduce the formation of hazardous substances. Process analytical technology represents an important tool in the pharmaceutical process developer's tool box, both for drug substance and drug product. The need to stock this tool box with greener technologies was highlighted as one of eight grand challenges for sustainability of the chemical and pharmaceutical industry for the 21<sup>st</sup> century.<sup>16</sup>

There have been significant developments over the past few years recognizing the importance of designing quality into pharmaceutical products. As part of the FDA's PAT initia-

tive,<sup>17</sup> FDA and pharmaceutical industry representatives have come together to define a framework for Quality by Design concepts. In this context, "the goal of PAT is to understand and control the manufacturing process, which is consistent with our current drug quality system: *quality cannot be tested into products; it should be built-in or should be by design.*" Similar wording is present in the ICH Guideline on Pharmaceutical Development (Q8) wherein it states, "It is important to recognize that quality cannot be tested into products, i.e., quality should be built in by design."<sup>18</sup> European regulators have an analogous initiative: "The PAT initiative focuses on building quality into the product and manufacturing processes, as well as continuous process improvement."<sup>19</sup>

For both industry and regulators, a desired goal of the PAT framework is to design and develop processes that can consistently ensure a predefined quality at the end of the manufacturing process. Such procedures would be consistent with the basic tenet of Quality by Design and could reduce both risks to quality and regulatory concerns while improving efficiency. Gains will vary depending on the product and are likely to come from:

- reducing production cycle times by using on-, in-, and/or at-line measurements and controls
- preventing re-processing, rejects and scrap
- considering the possibility of real time release
- increasing automation to improve operator safety and reduce human error
- facilitating continuous processing to improve efficiency and manage variability
- using small-scale equipment (to eliminate certain scale-up issues) and dedicated manufacturing facilities
- improving energy and material use and increasing capacity
- facilitating continual improvement, especially within the approved design space(s) to optimize process efficiency

Similarly, the goal of green chemistry's application of a PAT framework is that minimizing the environmental footprint of an API process must be an intentional act of design, "*Benign by Design*" or BbD. Quality by Design advocates seek reproducibly high quality processes and products with fewer process and product defects, leading to fewer rejects and reworks. Green chemistry advocates seek this outcome and a process or product that is much less intrusive to the environment. It is possible to have a synthetic process that is well designed, well understood, and well controlled, yet fails to meet any of the green chemistry metrics such as low E-Factors and higher atom economy.<sup>20</sup> Thus, the pharmaceutical processes that were recognized by the green chemistry challenge awards, while well controlled by cGMP standards, nevertheless could be improved in terms of robustness and reliability when examined by a green chemistry lens. In the future, instead of applying green chemistry principles to the redesign of API processes post regulatory approval, as has often been the case so far, a future state must be that green chemistry principles be incorporated into the design of the API manufacturing process

*Continued on page 14.*



# ELETTACQUA

*pure water technologies*

SINCE 1966

## PHARMACEUTICAL WATER SYSTEMS



DOUBLE PASS REVERSE OSMOSIS HIGH TEMPERATURE SANITIZATION

DESIGN AND CONSTRUCTION OF PURIFIED WATER PACKAGES ♦ DOUBLE PASS REVERSE OSMOSIS ♦ R.O. + ELECTRODEIONIZATION HOT WATER SANITIZABLE ♦ ULTRAFILTRATION ♦ MULTIPLE - EFFECT DISTILLATION UNITS ♦ PURE STEAM GENERATORS ♦ STORAGE AND DISTRIBUTION LOOP ♦ COMPLETE TURN KEY PROJECTS ♦ VALIDATIONS IQ, OQ

[www.elettracqua.com](http://www.elettracqua.com)

visit us at  
**ACHEMA 2009**  
Frankfurt am Main / Germany  
11. - 15. 5. 2009  
hall 4.1 - stand L20/L22



as early as possible in R&D.<sup>21, 22</sup> Lilly Research Laboratories developed a green synthesis for LY300164 with significant process, environmental, and safety improvements, yet the drug candidate never made it to market.<sup>9</sup> Quality by Design concepts, by themselves, may not be enough to drive substantial improvements in the environmental profile of API processes or lower their E-Factors. There are some impressive reports of using PAT tools to improve API manufacture, particularly in the areas of reaction completion and crystallization/particle size control<sup>23-28</sup> which can be translated or extended to yield environmental benefits.

The success of the pharmaceutical industry relies on its ability to be innovative. Reliance on conventional practices in quality or chemistry poses a threat to the viability of the industry and to public health for which the industry has dedicated its business. Both green chemistry and PAT are intended to support innovation. A mechanistic understanding of the process is the ultimate goal: a combination of conventional and green chemistry principles supported by PAT can yield this understanding more powerfully than conventional practices alone.

Process understanding would enable a chemist to develop a process that not only has quality, but sustainability designed in. While PAT is most clearly associated with the 11<sup>th</sup> principle of green chemistry: the incorporation of real time analysis for pollution prevention, the implementation of PAT affects many of the other principles as well. Using a generic example of online solvent monitoring during a drying operation, the sensors would indicate the optimal endpoint. If the dryer is stopped at the endpoint, the potential for generation of out-of-specification material is reduced (Green Chemistry Principle 1: Waste Prevention); dryer energy consumption is minimized (Green Chemistry Principle 6: Design for Energy Efficiency); and employee exposure to the API during routine sampling is reduced (Green Chemistry Principle 12: Inherently Safer Chemistry for Accident Prevention).

Pharmaceutical manufacturers recognize the green chemistry challenges presented by current methodologies for equipment cleaning.<sup>29</sup> An example by Johnson & Johnson was not selected for its use of solvents, but for its case study demonstrating the beneficial impact of UV spectroscopy during cleaning and cleaning validation. The study concluded the benefits of PAT to include improved quality by enabling detection of cross-contamination risks, improved cleaning process design based on improved process understanding of temperature, pressure, and hold time factors, more than 40% reduction in cycle time, and 40% cost reduction due to reduced solvent usage and waste reduction.<sup>30</sup>

## The Parallels of QbD and BbD

ICH has defined a **Critical Quality Attribute (CQA)** as, “A physical, chemical, biological, or microbiological property or characteristic that should be within an appropriate limit, range, or distribution to ensure the desired product quality.” The term **quality** was defined in ICH Q6A as, “The suitability of either a drug substance or drug product for its intended use. This term includes such attributes as the

identity, strength, and purity.” However, given the concerns that society has regarding environmental impact, is society prepared to pursue this definition of quality without regard to the environment?

Take, for example, the lengths the industry goes to in order to reduce the levels of impurities in APIs. While there is always a risk associated with the presence of impurities in APIs and drug products, an agreement was reached within ICH over the concept of a qualified level of an impurity. **Qualification** is the process of acquiring and evaluating data that establishes the biological safety of an individual impurity or a given impurity profile at the level(s) specified. Therefore, there is an agreement that once an impurity is below a particular level, it can be considered ‘safe.’ Despite this agreement, specification acceptance criteria for impurities are constantly under pressure during the regulatory review process to be reduced – sometimes to a concept of As Low As Reasonably Practical (ALARP). Such practicality rarely considers the environmental impact of the energy input and waste solvent disposal that may ensue as a consequence of demanding impurity levels be considerably lower than their qualified levels. In the 21<sup>st</sup> Century, it may be appropriate to consider whether quality should be redefined as, “The suitability of either a drug substance or drug product for its intended use. This term includes such attributes as the identity, strength, and purity, together with the environmental impact of its production.”

Maybe this seems a step too far? Then it may alternatively be helpful to extend the definition of a **Critical Process Parameter** as, “A process parameter whose variability has an impact on a critical quality attribute and therefore should be monitored or controlled to ensure the process produces the desired quality. Green chemistry could define a **Critical Environmental Parameter (CEP)**. A CEP could be defined as “a physical, chemical biological, or microbiological characteristic that should be within an appropriate limit, range, or distribution to ensure the desired environmental outcome” - *Figure 1*.

The parallels then with the ICH guideline become clear. For example, ICH Q8 states:

*“At a minimum, those aspects of drug substances, excipients, container closure systems, and manufacturing processes that are critical to product quality should be determined and control strategies justified. Critical formulation attributes and process parameters are generally identified through an assessment of the extent to which their variation can have impact on the quality of the drug product.”*

This could be re-presented as:

*“At a minimum, those aspects of drug substances, excipients, container closure systems, and manufacturing processes that are critical to the environment and to product quality should be determined and control strategies justified. Critical formulation attributes, process parameters, and environmental parameters are gener-*

ally identified through an assessment of the extent to which their variation can have impact on the quality of the drug product and the environmental impact of its production.”

However, the Annex to Q8 (Q8(R1) currently at Step 4) goes further to distinguish between the minimum expectations and QbD. “An enhanced, Quality by Design approach to product development would additionally include the following elements:

A systematic evaluation, understanding, and refining of the formulation and manufacturing process, including:

- identifying, through, e.g., prior knowledge, experimentation, and risk assessment, the material attributes and process parameters that can have an effect on product CQAs
- determining the functional relationships that link material attributes and process parameters to product CQAs

Using enhanced process understanding in combination with quality risk management to establish an appropriate control strategy can, for example, include a proposal for design space(s) and/or real-time release.

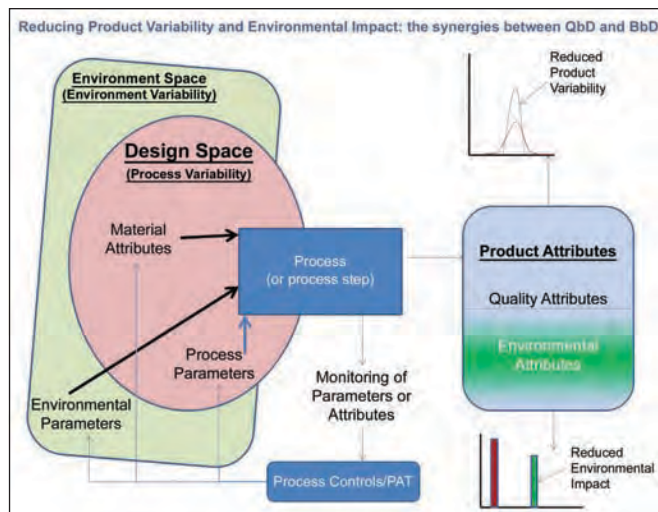

Figure 1. Benign by Design (BbD): A systematic approach to development that begins with predefined environmental objectives and emphasizes product and process understanding aimed at realizing environmentally benign manufacturing processes.

As a result, this more systematic approach could facilitate continual improvement and innovation throughout the product lifecycle (See ICH Q10 Pharmaceutical Quality System).

In BbD practice, the development scientist focusing on the enhanced approach would add to their target product profile,

*Continued on page 16.*

**Push a button and walk away**



**Automate your TOC analysis**



Be Right™

## Anatel PAT700: The first TOC analyzer for on-line release

- Simplify validation and reduce operator intervention with OASIS™ Onboard Automated Standards Introduction System
- Provide peace of mind, superior reliability and uptime with UV Detect™ and advanced diagnostics
- PAT design for compliance in the most demanding regulatory environments

**Call or email to schedule your demonstration:**

HACH COMPANY World Headquarters  
Toll Free: 800-866-7889  
Fax: 970-461-3914  
Email: [orders@hach.com](mailto:orders@hach.com)  
[www.hach.com](http://www.hach.com)

CQAs, and CPPs a series of environmental goals (CEPs) that would need to be met. Subsequent quality risk management processes would be used to identify those elements of the API or drug product manufacture that would put those goals at risk. Design of Experiments would then have a combination of both quality and environmental attributes that would need to be met and any design spaces that are created would consider both attributes. Referring back to the example of impurities, it becomes easy to see that there may well be an optimum region within a design space where impurity levels will be below their qualified levels **and** environmental impact can be minimized.

## Future Green Chemistry and Engineering Initiatives that Include PAT

It has been argued that the industry, or any industry for that matter, is reluctant to “green” a process in the absence of clear economic incentives.<sup>31</sup> The business case for PAT has been documented on several occasions,<sup>32,33</sup> but many fail to explicitly incorporate the environmental and safety benefits: cost avoidance from the avoidance of waste generation and disposal due to out-of-specification material, waste from reprocessing, energy and water consumption with reduced cycle times, etc. More recently, that situation is changing with recognition of the synergies between PAT, QbD, and a number of the principles of green chemistry.<sup>34</sup> The business case for PAT is only enhanced by the recognition of green chemistry principles.

In 2005, sales of generic drugs passed \$28 billion in the United States.<sup>35</sup> Over the next several years, as much as \$80 billion worth of prescription drugs goes off patent and the third world economies like India and China will begin to consume these drugs as well. As stated previously, the vast majority of APIs for products past patent expiry are manufactured using processes developed without the insight of green chemistry. Moreover, those processes for APIs nearing Loss of Exclusivity (LOE) which have been redesigned using green chemistry principles are protected by process patents which will be in force long after the composition of matter patents expire. Soon discerning analytical methods will be able to detect the unique impurity signature of each process variant almost at the molecular level. PAT is being used in the generic pharmaceutical industry.<sup>36</sup> Using generic versions of green branded drugs manufactured without an improvement in the environmental signature of API process that result from application of green chemistry principles can pose an additional environmental burden. Based on the E-Factor improvements achievable using green chemistry principles, this can be on the order of 10-fold or more. Developing green versions of processes for generic drugs represents a great opportunity for innovation.

Biopharmaceutical drugs such as vaccines, proteins, and monoclonal antibodies represent one of the fastest growing segments of the prescription drug industry with many companies in this sector seeing as much as 30% or more growth in sales in 2007 over 2004. The FDA's Webber<sup>37</sup> has analyzed these products in terms of the opportunities to use PAT tools to control the manufacturing processes for both API and dosage

form. Very little discussion into the green chemistry issues has appeared so far. Anecdotal comments such as “these products are green because they are made in water” oversimplify this issue.

Water shortage is becoming a critical issue, addressed at the 2008 World Economic Forum in a challenging discussion paper.<sup>38</sup> The discussion paper forecasts:

“Significant business disruptions due to water scarcity – across all sectors and geographies, and with all the associated technical, economic, political, environmental, and social implications – *are a reality today*, and are projected to *worsen in the future*, as a result of climate change and demographics. Governments play an important role in helping to mitigate and adapt to the challenge, but so does the private sector, through individual company actions and through innovative public-private and multi-stakeholder partnerships. CEOs are called to catalyse holistic water management actions up and down their respective supply chains and throughout the existing and new networks of which they are a part.

The focus of actions should include:

- water governance for transparent/fair allocation to users and sound incentives for efficient water use
- water for agricultural use (“more crop per drop;” 70% of water withdrawn worldwide)
- water for industry (water efficiency within operations)
- water for energy (the deepening link between water resources and climate change)
- water for human purposes (sustainable and affordable access to safe drinking water and sanitation)
- water for the environment (to ensure sustained eco-system security)

Therefore, it behooves the pharmaceutical industry to address its use of water in all its processes, both for API manufacture and in drug product manufacture. Genentech's 2005 environmental sustainability report<sup>39</sup> commits to water and energy usage reduction goals, water from a baseline of almost 900 kilograms per kilogram of marketed product. This number far exceeds water usage for the manufacture of a typical small molecule API and is more in line with what is reported for the manufacture of computer chips in the electronic materials.<sup>40</sup> Better process understanding for these molecules through application of PAT and application of green chemistry to process design should lead to a reduction in water and energy consumption with an overall improvement in their environmental footprint.

As pharmaceutical companies seek to streamline their API manufacturing processes, they are looking to technologies that have been common practice for other parts of the chemical enterprise. For example, separation technology such as Multi-column Chromatography (MCC) has been used to manufacture chiral versions of racemic drugs and starting materials such as escitalopram,<sup>41</sup> the chiral teralene for Pfizer's sertraline process<sup>42</sup> and tenofovir.<sup>43</sup> These preparative separation ap-



proaches which are tailor made for PAT, can reduce solvent utilization by as much as 10-fold over traditional preparative HPLC methods. Solvents that are recovered and reused can be purified using PAT methods to monitor quality, possibly improving recovery efficiency.

More recently, there has been a growing interest in Supercritical Fluid Chromatography (SFC).<sup>44</sup> This separation option will undoubtedly benefit from PAT enhancements as well. Perhaps the most revolutionary approach to API manufacture is continuous processing. Until now, APIs almost always have been manufactured in the batch mode. Conversely, basic chemicals and petroleum products are made in continuous flow reactors. Academic research groups are developing processes based on flow chemistry concepts.<sup>45,46</sup> Soon, if not already, these approaches will make their way into pharmaceutical industry R&D organizations, from the laboratory through pilot plant, and eventually into full scale production. The approach is being driven by considerations of speed to the market and the difficult R&D paradigm of solving scale issues, essentially reinventing the process several times moving from milligram to multi ton quantities. Unlike scaling up this new approach often called numbering up<sup>47</sup> or numbering out relies on defining critical process operating conditions at a fixed scale, then replicating that scale equipment as material demand increases. The benefits of integrating PAT into this new approach are obvious.

## Conclusion

Benign by Design (BbD) and Quality by Design (QbD) concepts are complimentary with both directed toward improving the understanding and the robustness of an API manufacturing process. In fact, as PAT practitioners in the pharmaceutical industry apply both BbD and QbD lenses, they may find a synergistic result (i.e., 1+1 = 3). Development scientists who fail to take advantage of the opportunity for PAT to improve the environmental profile may miss a significant economic benefit that comes from waste minimization or avoidance.

Finally, it appears most of the attention for QbD has been given to dosage form or drug product. On the other hand, formulations and packaging have received little attention from green scientists so far. Moreover, some of the emerging innovative drug delivery platforms that can increase oral bioavailability and/or target drug delivery to the desired physiological site offer great promise for reducing the environmental footprint of pharmaceutical manufacturing in their own right. A more efficient and effective formulation could achieve the same efficacy with less drug, reducing the need for API synthesis and lessening the burden of drug excreted into the environment. Once these new platforms are in hand, a detailed lifecycle analysis will be required to confirm or refute this prediction.

## References

1. [www.pharma.org](http://www.pharma.org).
2. Young, J. and Sachs, A., The Next Efficiency Revolution: Creating a Sustainable Materials Economy, Worldwatch Institute (Washington, DC), 1994, p. 13. [www.grrn.org](http://www.grrn.org).

*Continued on page 18.*

 **BUDZAR**  
INDUSTRIES, INC.

Your Single Source Solution Provider

## Reactor Temperature Control Module

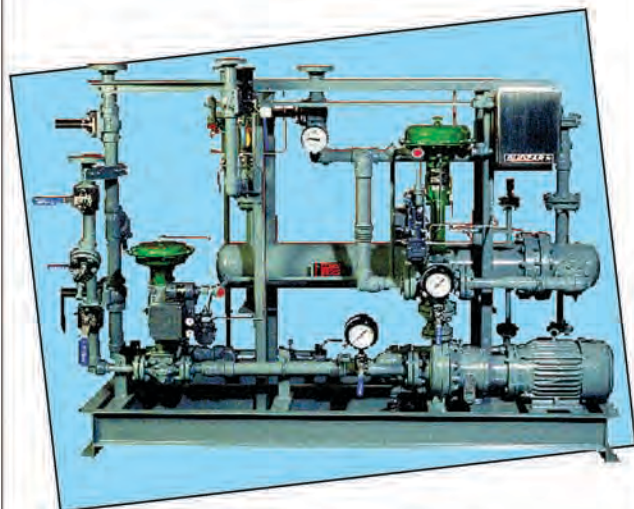

### Features Include:

- ◆ Temperatures from -100° - 700° F
- ◆ Water, glycol or heat transfer fluids
- ◆ Indoor, Outdoor and Explosion Proof
- ◆ Interface with all types of Plant Utilities
- ◆ Local, PLC or DCS Control Systems
- ◆ Batch size capacity to 10,000 gallon vessels
- ◆ Single Zone or Multi-Zone Designs
- ◆ NEMA 12, 4 or 7 electrical components & enclosure
- ◆ Direct Injection or Closed Loop Cooling
- ◆ Steam or electrical heater size of 4.5kW to 300 kW

Budzar Industries has specialized in process fluid heat transfer systems since 1975 and has earned a global reputation for quality and ingenuity in the design, engineering, and manufacturing of temperature control systems. Budzar Industries systems are found throughout the world, delivering accurate temperature measurement and control to the production of pharmaceuticals, chemicals, petroleum, rubber, power, steel, food, and plastics.

**Budzar Industries**  
38241 Willoughby Parkway  
Willoughby, Ohio 44094  
440-918-0505 • [www.Budzar.com](http://www.Budzar.com)

3. Wackernagel, M. and Rees, W., **Our Ecological Footprint: Reducing Human Impact on the Earth**, Philadelphia, Pennsylvania: New Society Publishers, 1996 and Hawkin, P., Lovins, A.B., and Lovins, L.H., **Natural Capitalism: Creating the Next Industrial Revolution**, Little, Brown & Company, 1999.
4. Sheldon, R.A., "Green Chemistry Performance Metrics: E-Factor," *Chem Tech*, Vol. 24, pp. 38-47.
5. Henderson, R.K., Kindervater, J., and Manley, J.B., "Lessons Learned Through Measuring Green Chemistry Performance – The Pharmaceutical Experience," presented at the 11<sup>th</sup> Annual Green Chemistry and Engineering Conference, Washington, DC, June 2007. [http://portal.acs.org/portal/fileFetch/C/CTP\\_005585/pdf/CTP\\_005585.pdf](http://portal.acs.org/portal/fileFetch/C/CTP_005585/pdf/CTP_005585.pdf)
6. Jimenez-Gonzalez, C, Curzons, A.D., Constable, D.J.C., and Cunningham V.L., "Cradle-to-Gate Life Cycle Inventory and Assessment of Pharmaceutical Compound," *International Journal of Life Cycle Assessment*, Vol. 9, No. 2, pp. 114-121.
7. Anastas, P.T. and Warner, J.C., **Green Chemistry: Theory and Practice**, New York, New York: Oxford University Press Inc., 1998.
8. [www.epa.gov/greenchemistry](http://www.epa.gov/greenchemistry).
9. EPA bulletin 744F08002, June 2008, [www.epa.gov/greenchemistry](http://www.epa.gov/greenchemistry).
10. Process Change in the Pharmaceutical Industry, Merck & Co., Inc. – Cherokee Plant, Source Reduction Success Story #4, Pennsylvania Source Reduction Program, April 1994.
11. Thomas, P., "The Greening of a Roche API Process: Pollution Prevention Pays," PharmaManufacturing.com, <http://www.pharmamanufacturing.com/articles/2006/175.html?page=print>.
12. [http://www.imshealth.com/ims/portal/front/indexC/0,2773,6599\\_83743725\\_0,00.html](http://www.imshealth.com/ims/portal/front/indexC/0,2773,6599_83743725_0,00.html)
13. Manley J.B., Anastas, P.T., and Cue, B.W., Jr., "Frontiers in Green Chemistry: Meeting the Grand Challenges for Sustainability in R&D and Manufacturing," *J. Cleaner Production*, 16 (2008), pp. 743-750.
14. Juran, J.M., "Juran on Quality by Design: The New Steps for Planning Quality into Goods and Services," *The Free Press*, 1992, ISBN 0-02-916683-7.
15. Winkle, H., Implementing Quality by Design, PDA/FDA joint Regulatory Conference, September 2007, <http://www.fda.gov/Cder/OPS/ImplementingQualitybyDesign.pdf>.
16. Sustainability in the Chemical Industry. Grand Challenges and Research Needs: A Workshop Report, Committee on Grand Challenges for Sustainability in the Chemical Industry, Board on Chemical Sciences and Technology, National Research Council, National Academies Press, 500 Fifth St., N.W., Washington, DC 20001, 2005. ([http://books.nap.edu/catalog.php?record\\_id=11437#toc](http://books.nap.edu/catalog.php?record_id=11437#toc)).
17. <http://www.fda.gov/cder/OPS/PAT.htm#Introduction>.
18. [www.ich.org](http://www.ich.org).
19. <http://www.emea.europa.eu/Inspections/PAThome.html>.
20. Trost, B.M., "The Atom Economy – A Search for Synthetic Efficiency," *Science*, Vol. 254, No. 5037, pp. 1471-1677.
21. Masanori, N., "Green Chemistry in Process Research and Development in Pharmaceutical Industry," *Journal of Synthetic Organic Chemistry*, Japan, Vol. 61, No. 5, pp. 464-471.
22. Erdhart, P.W., "Medicinal Chemistry in the New Millennium, a Glance into the Future," **Drug Discovery and Development**, Vol. 1; Chorghade, M.S., (Editor). Wiley-Interscience, ISBN: 9780471398486 (2006)
23. Thayer, A., "Know Thy Process," *Chemical and Engineering News*, Vol. 83, No. 22, pp 63-67.
24. Hammond, S., *The Journal of Process Analytical Technology*, Vol. 2, No. 4, pp. 15-7.
25. Rodrigues, L.O., Marques, J.L., Cardoso, J.P., Menezes, J.C., *The Journal of Process Analytical Technology*, Vol. 2, No. 3, p.12.
26. Higgins, J., Green, R., Pizley, N., Kleissas, K., Saikia, S., Chow, J., Zimmerman, J., Colvin, P., Plank, R., Hunke, B., Zega, J., Witulski, F., John, C., Smith, E., Bowen, B., Mateos, A., Reynolds, S., and Reed, R., *The Journal of Process Analytical Technology*, Vol. 2, No. 5, p. 23.
27. Szechinski, W., "PAT Application in Active Pharmaceutical Ingredient (API) Manufacturing and the Advancement to Real-Time Release," *The Journal of Process Analytical Technology*, Vol. 9, No. 6, pp. 20-22.
28. Hinz, D.C., *The Journal of Process Analytical Technology*, Vol. 1, No.2, pp.16-18.
29. Constable, D.J.C., Dunn, P.J., Hayler, J.D., Humphrey, G.R., Leazer, J.L., Jr., Linderman, R. J., Lorenz, K., Manley, J., Pearlman, B.A., Wells, A., Zaks, A., and Zhang, T.Y., "Key Green Chemistry Research Areas – A Perspective from Pharmaceutical Manufacturers," *Green Chemistry*, Vol. 9, No. 5, pp. 411-420.
30. Helings, M. and Vanbaelen, H., "The Application of PAT for Cleaning and Cleaning Validation," *American Pharmaceutical Review*, Issue 4, 2008, <http://www.american-pharmaceuticalreview.com/ViewArticle.aspx?SID=d5myce55zcrnzo232vkkxxia&ContentID=3587>.
31. DePalma, A., "Green Processing," *Pharmaceutical Manufacturing*, Vol. 5, No. 4, pp. 34-35.
32. Henningsson, U., *The Journal of Process Analytical Technology*, Vol. 2, No. 4, pp. 8-11.
33. Hormaza, M., "Overcome PAT's Barriers and Find its True Business Value," *Pharmaceutical Manufacturing*, <http://www.pharmamanufacturing.com/articles/2006/014.html>.
34. Woelbeling, C., Creating Quality by Design/Process Analytical Technology (QbD/PAT) Management Awareness, *Pharmaceutical Engineering*, Vol. 28, No.4.
35. <http://www.medicalnewstoday.com/medicalnews.php?newsid=30938>.
36. Lo, S.C., Venkatesh, K., and Foster Roberts, G., *The Journal of Process Analytical Technology*, Vol. 3, No. 1, p. 13.
37. Webber, K., "FDA Update: Process Analytical Technology for Biotechnology Products," *The Journal of Process Analytical Technology*, Vol. 9, No. 4, pp. 12-14.
38. <http://www.weforum.org/pdf/water/managing.pdf>.
39. <http://www.gene.com/gene/about/environmental/commitment/water.jsp>.

# Solutions for your successful Life Science Environments



Success in the life science industry is based on excellent environmental conditions. Let Siemens be your reliable partner providing safe, secure and compliant environments along each step of your value chain. Your investment is protected because we focus on the entire life cycle of your installation. Your environments are compliant because our solutions are based on all-inclusive systems and services developed specifically for the life science industry, and we can offer you decades of knowledge and experience in this industry – worldwide.

[www.siemens.com/buildingtechnologies-pharma](http://www.siemens.com/buildingtechnologies-pharma)

**SIEMENS**

40. Williams, E.D., Ayres, R.U., and Heller, M., "The 1.7 Kilogram Microchip: Energy and Material Use in the Production of Semiconductor Devices," *Environmental Science and Technology*, Vol., 36, No. 24, pp. 5504-5510.
41. Containing Resolution: The Novasep Newsletter, November 2001, www.novasep.com.
42. Hawkins, J.M. and Watson, T.J.N., "Asymmetric Catalysis in the Pharmaceutical Industry," *Angewandte Chemie International Edition*, Vol 43, No. 25, pp.3224- 3228.
43. Chemical Week Associates, CPhI Review, December 10, 2003.
44. Thayer, A., "Trial Separations," *Chemical and Engineering News*, Vol. 83, No. 36, pp. 49-53.
45. Baxendale, I.R., Deeley, J., Griffiths-Jones, C.M., Ley, S.V., Saaby, S., and Tranmer, G.K., "A Flow Process for the Multi-Step Synthesis of the Alkaloid Natural Product Oxomaritidine: A New Paradigm for Molecular Assembly," *J. Chem. Soc., Chem. Commun.*, pp. 2566-2568.
46. Broadwater, S.J., Roth, S.L., Price, K.E., Kobaslija, M., and McQuade, D.T., "One-Pot Multi-Step Synthesis: A Challenge Spawning Innovation," *Org. Biomol. Chem.*, Vol. 3, 2899-2906. Also, Choi, C.Q., "Nano World: Edible Nanotech on the Horizon," 11 February 2005.
47. For a discussion of numbering up and flow reactor concepts see M. Freemantle, *ACHEMA 2003 Report* contained in *Chemical and Engineering News*, Vol. 81, No. 24, pp 36-37.

## About the Authors



**Dr. Berkeley (Buzz) W. Cue**, consults with several technology companies who serve the pharmaceutical industry to create innovative solutions for pharmaceutical science and manufacturing challenges through BWC Pharm Consulting, LLC. Most recently, at Pfizer, he was responsible for the departments: Analytical R&D, Bio Process R&D, Chemical

R&D, Pharmaceutical R&D, Regulatory CMC, and Quality Assurance, and Pharmaceutical Sciences Business Operations that comprise Pharmaceutical Sciences at their Groton R&D site. He was a member of the Worldwide Pharmaceutical Sciences Executive Team, sponsored the global Chemical R&D line council, and was a member of the Groton Laboratories site Leadership Team. He created and led Pfizer's Green Chemistry initiative and has spoken extensively on this topic since 2000. Cue retired from Pfizer in April 2004 after almost 29 years, but he continues his mission of advancing green chemistry in the pharmaceutical industry. Since his retirement in 2004, he has given more than 80 presentations on green chemistry in the pharmaceutical industry. His professional society memberships include the American Chemical Society (ACS), ISPE, the American Institute of Chemical Engineers (AIChE), the American Association of Pharmaceutical Scientists (AAPS), and the New England Association of Chemistry Teachers (NEACT). He can be contacted by email: [b.cue@comcast.net](mailto:b.cue@comcast.net).

BWC Pharma Consulting, LLC., 12 Eska Dr., Ledyard, Connecticut 06339, USA.



**Dr. John Berridge** retired from Pfizer Global Research and Development at Sandwich in January 2006 as Vice President of Pharmaceutical Sciences. He spent more than 31 years at Pfizer, starting as an Analytical Chemist, and more recently responsible for all aspects of chemistry, pharmacy, analytical, and regulatory CMC in Europe. His research

interests have been directed toward high performance liquid chromatography with special emphasis on the use of chemometrics. This research was recognized by the award of the Chromatographic Society's Jubilee medal in 1989. Berridge was involved in the ICH processes from their inception until November 2007, representing EFPIA in the Quality topics discussions. He has contributed to guidelines on impurities in drug substances and their dosage forms, specifications, and the Common Technical Document (Quality); he was the Industry rapporteur for the pharmaceutical development guideline (Q8). In 1995, he was presented with an FIP IPS award for his outstanding contribution to industrial pharmacy and in 1997, he was awarded the Royal Pharmaceutical Society Chiroscience award for his services to the pharmaceutical industry. Berridge now acts as an independent consultant and as European Regulatory Affairs Advisor to ISPE. He can be contacted email: [john.berridge@orange.net](mailto:john.berridge@orange.net).



**Julie B. Manley** is President and Owner of Guiding Green, LLC, a sustainability consulting firm near Chicago, Illinois. Following approximately 10 years at Abbott Laboratories in manufacturing and environmental health and safety functions, Manley founded Guiding Green, LLC to have a broader impact on sustainability in the global pharmaceutical

industry. While Guiding Green, LLC initially focused on green pharmaceutical science and it will always remain a high priority, the organization has expanded the scope of work to help integrate sustainable practices in the broader industrial enterprise. Since 2005 she also has acted as the Senior Industrial Coordinator for the American Chemical Society Green Chemistry Institute® (ACS GCI) where she manages the ACS GCI Pharmaceutical Roundtable. Manley earned a BA from Northwestern University, Evanston, Illinois and a Master of Public Health from the University of Michigan, Ann Arbor, Michigan. She also is a Certified Hazardous Materials Manager (CHMM) by the Institute of Hazardous Materials Management. Manley has authored several papers on the subject of sustainability and green chemistry in peer reviewed and trade journals and presented on related subjects. She can be contacted by telephone: +1-815-325-4974 or by email: [julie.manley@GuidingGreen.com](mailto:julie.manley@GuidingGreen.com).

Guiding Green, LLC., 26508 W Melissa Dr., Channahon, Illinois 60410, USA. 



## Certified Pharmaceutical Industry Professional™ (CPIP™) Certification Program

Is a credential based on an international, knowledge and skills competency standard. It is for industry professionals around the world working in and supporting product development through manufacturing, and benefits entry level, mid-career and senior level professionals and their employers.

The CPIP certification program can unlock greater career opportunities for professionals and provide companies a competitive advantage, especially during challenging economic times.

### **For Practitioners with 7 Years Experience, or Less**

---

*A professional development pathway* to acquire knowledge and skills for application anywhere in the world

### **For Practitioners with More Than 7 Years Experience**

---

*Industry-wide recognition* of accumulated experiences, knowledge, and ability to apply innovative thinking and solutions

### **For Employers**

---

Professionals with diverse knowledge and skills certified to *a global competency standard*

### **For Service/Equipment Providers**

---

Realization of *that competitive advantage*—having CPIPs on your project teams confirms a commitment to providing high-quality services

This article discusses the critical requirements for a Process Analytical Technology (PAT) data management solution and how these requirements contribute to the successful operation of the PAT solution.

## Introduction to PAT Data Management Solutions

by Mark N. Reed

### Introduction

This article will discuss the critical requirements for a PAT<sup>1</sup> data management solution and how these requirements contribute to the successful operation of the PAT solution with the end goal of real time product release. PAT Data Management is used in multiple phases of the PAT implementation model. The three phases of all PAT projects are learn, predict, and control. The learning phase comes from the data that is collected, as you “learn” more about your process. The data is then used to build models to “predict” what the process will do when a variation occurs. The model outputs are used to feedback control adjustments to the process control system in the control phase of the project.

First, in the learning phase, there are the process inputs that are collected from the process control system, laboratory analyzers, and the on-line analyzers. When using analyzers, there are software tools in the PAT data management system that allow the user to calibrate the analyzers to accurately detect the substance they are measuring to ensure the quality of the collected data. This calibration of an analyzer to a particular substance is called a method.<sup>2</sup>

Second, there is the storage of this data that allows understanding and predicting of the process. This data storage is performed by an industry standard database (historian) that accepts various input types and formats. It allows the user to pinpoint a specific event or to analyze the data to optimize the process. Chemometricians use univariate or (more typically) multivariate data analysis tools to analyze the data they obtain from the historian. A model that describes how the process is running can be developed using tools that provide outputs to the process control system that then send outputs to final control elements such as control valves and other types of actuators.

In the third phase, the process control system adjusts the Critical Process Parameters (CPPs) to adjust the process to obtain the desired Critical Quality Attribute (CQA) values. These CQAs are monitored and reported to the PAT system in real-time by the on-line instruments and analyzers. Business related attributes also need to be identified and considered as part of the overall PAT process. Visualization is another data analysis tool that allows the operator to inspect a graphic display to find where the process is operating within or outside of the

Figure 1. Examples of scalar data (left) and spectral data (right).

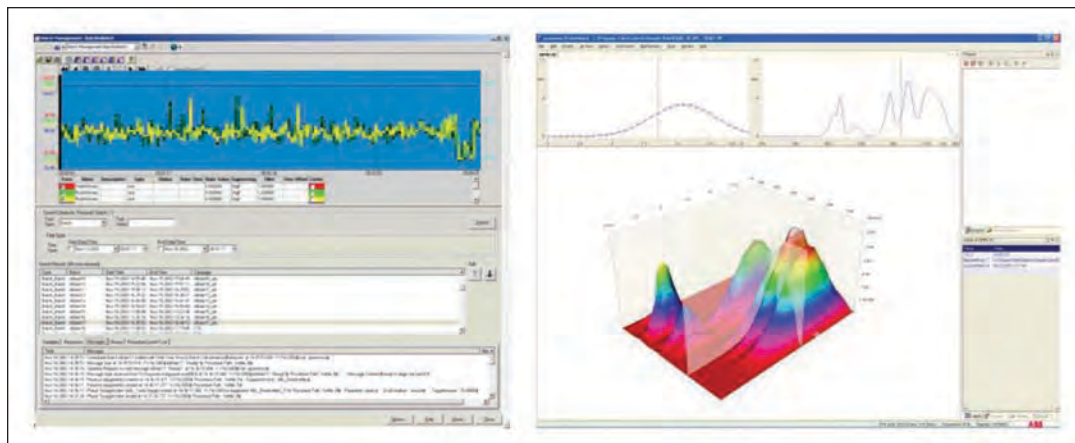

Continued on page 24.

**In commissioning, validation and compliance, teamwork and timing are everything.**



COMMISSIONING AGENTS. We're in position, skillfully negotiating every turn to help you get to your project's finish line faster and more efficiently. Our teams undergo a rigorous program of structured training, qualification, and continuous professional development. You'll find we aren't selling individual resumes, we're selling a high performance team.

**For every project, teamwork and timing are everything.**



Commissioning Agents, Inc.

[WWW.COMMISSIONINGAGENTS.COM](http://WWW.COMMISSIONINGAGENTS.COM)

- ▶ **Commissioning planning and field execution**
- ▶ **Validation planning, protocol development and execution**
- ▶ **Process validation, cleaning, sterilization and computer validation**
- ▶ **Process improvement services: Process Analytical Technology (PAT), technology transfer and process studies**
- ▶ **Technical services including design reviews, SOP development, maintenance programs and training**
- ▶ **cGMP compliance audits and regulatory reviews, compliance improvement projects, comparability protocols and other submission assistance**

**Achieve world class manufacturing.**

**Call Robert E. Chew, P.E., Vice President**  
**[Robert.Chew@CAgents.com](mailto:Robert.Chew@CAgents.com)**  
**+1.317.710.1530**

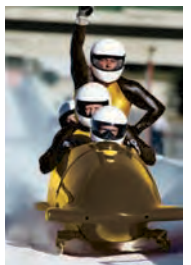

desired state defined by the process design space.

The overall technical requirements to consider in a PAT data management solution that will be discussed are the different types of data that needs to be stored, how the data will be stored, how the integration to the batch management system is done, and what FDA regulations need to be considered.

## Analyzer Data for Understanding the Process

There are many options on the market today to measure CQAs in real-time. Facilities may have multiple analyzers from multiple vendors throughout a site. How are these managed? How is data collected? How are the methods managed? Instrumentation and analyzers can be laboratory or process units that have outputs of either scalar (univariate) or spectral (multivariate) data which are available from various manufacturers. There are two categories of outputs that an analyzer presents to the user for measuring the attributes of the process - *Table A, Figure 1*.

Many or all of these are used by life science companies to measure CQAs. FT-NIR is, by far, the most widely used and proven analytical technology for PAT applications.<sup>3</sup> FT-NIR is the most popular due to its noninvasive nature with no sample preparation needed. It uses fiber optically coupled

Scalar Data	Spectral Data
Pressure	Fourier Transform Infrared (FT-IR),
Level	Fourier Transform Near-Infrared (FT-NIR)
Flow	Ultraviolet-Visible spectroscopy (UV-VIS)
Temperature	Raman
Conductivity	Focused Beam Reflectance Measurement (FBRM)
pH	Continuous Gas Analyzers (CGA)
Particle Size	Gas Chromatography (GC)
TOC	Mass Spectroscopy (MS)
	High Performance Liquid Chromatography (HPLC)

Table A. Examples of typical devices used in process measurements.

probes; these probes can be remote from the analyzers with several probes multiplexed into a single NIR unit.

Turnkey solutions that utilize these analytical methods on a unit-by-unit basis have been available for years. Unit solutions include reactors, dryers, solvent recovery, crystallization, raw material identification, blending, spray coating, solid dose uniformity, lyophilizations, and many others. However, these analyzers typically do not share a common data format or operator interface and do not easily exchange this

## Data Storage

To complete the first step of the “learn, predict, and control” process, data from the process must be collected and stored. There are two basic types of process and laboratory data measurements - scalar and spectra. Scalar measurements are typical process values, i.e., temperature, pressure, flow, pH, conductivity, TOC, particle size, level, etc. that are collected from process measurements and some types of analyzers. Spectral data (spectroscopic raw data) is generated by laboratory and process analyzers, is in the form of multiple arrays of data with timestamps, and is much larger and more complex than a typical scalar signal. Because of its three dimensions, it also is called vector data. Spectral data is collected and used everyday in laboratories and production areas, but is typically set up as standalone equipment with an individual workstation and analyzer or they are connected to a common network of identical analyzers. Rarely is the spectral data combined with data from other types of analyzers or from a process control system in a single database that allows an analysis from multiple data streams or allows ease of data retrieval.

A data manager to collect and store information for discrete, continuous, and batch processes should be structured according to the procedure and associated with the lot (batch or work order) ID. Lot information should include all spectral and scalar data and the meta-data with which it is associated. This includes data from control recipe execution, operator actions and comments, process alarms/events from equipment acquired by batch, runtime changes, the methods that the analyzers used

during their analysis, version control of the methods, the spectral data from laboratory and process analyzers, and the scalar data from the process. By storing the data in a format that associates it with the lot, it is easy to display and/or report any information from a specific lot or from an entire campaign. This retrieval would take advantage of today’s batch engines that use an ISA-88 model that defines a data structure for recipes, equipment, schedules, and history, along with integration to enterprise applications. This allows complete ease of recalling and using the data, as it is the same format as the process recipes and analyzer PAT methods.

To complete the second step of the “learn, predict, and control” process, the information learned during the first step must be organized and modeled to form a set of predictions for various process changes. After collecting the CQAs, tools are used to model the multivariate data to create predictions that characterize the batch - *Figure 2*. The output from this modeling identifies the status of the batch during each process step and predicts its output to the next process step and to the last process step that delivers the final product. Comparing predicted values from the current batch to a set of values recorded from acceptable batches provides a tool for assuring the quality level of in-process batches. This can be called operating to a golden batch, within the control space, or can be classified as Advanced Process Control (APC), but the result is the same; a way to predict the outcome of a batch based on the real time process measurements.

*Continued on page 26.*



# A Single Resource...



Site  
Integration



Infrastructure  
Integration



Product  
Integration



Process  
Integration

## for TOTAL Cleanroom Confidence.

**Planning & executing the right cleanroom solution for your critical process.**

AES is your single resource to deliver fast track solutions for Pharma & BIO applications, such as:

- API Clean Containment
- Low cost ISO 8/CNC Macro Environments
- Fill/Finish Processes
- Cell Manufacturing Facilities
- Blow/Fill/Seal Facilities
- EU/Grade A Laminar Flow Upgrades

With the AES Pharma Wall System, combined with our expert knowledge of HVAC and process integration, let us show you how the AES "single resource" team can deliver maximum value to your cleanroom investment.

Call Grant Merrill at 888-237-2532 (ext. 139) to arrange your free consultation today.

**VISIT AES AT  
BIO Atlanta, GA**  
Booth 1433  
May 19, 20, & 21, 2009



**aes**

Clean Technology, Inc.

**1-888-AES-CLEAN ext. 139**  
237-2532

[aesclean.com](http://aesclean.com)

data with the plant's process control system and historical systems. In addition, the analyzers sample the process and produce results on different time frequencies determined by the amount of time the sampling takes and the sampling needs of the process. In a typical facility using these unit PAT operations, using multiple analyzers lead to large amounts of manual collection and correlation of the data from the facility's "islands of information." Having a system to provide a common user interface and common method development tool for different types of analyzers would enhance usability while reducing the system's training and long-term support costs.

On the topic of data, the FDA states:

*"Process analyzers typically generate large volumes of data. Certain data are likely to be relevant for routine quality assurance and regulatory decisions. In a PAT environment, batch records should include scientific and procedural information indicative of high process quality and product conformance. For example, batch records could include a series of charts depicting ac-*

*ceptance ranges, confidence intervals, and distribution plots (inter- and intrabatch) showing measurement results. Ease of secure access to these data is important for real time manufacturing control and quality assurance. Installed information technology systems should accommodate such functions."<sup>4</sup>*

An analyzer has a calibration associated with it that is comprised of a collection of spectral data and a customizable set of parameters describing a particular analysis procedure. These calibrations are used in quantitative and qualitative analysis either to find out an amount of a particular substance contained in a sample or to prove the identity of a substance or compound. Based on these pre-calculated results, reliable predictions for the identity of or an amount of a substance in an unknown sample can be made.<sup>5</sup> Calibration methods are used to control a set of calibration models that have had corresponding discrimination criteria introduced to them to avoid model selection problems and misleading result interpretation. Prior to a particular lot being started, these methods must be downloaded to the analyzer and confirmed by the

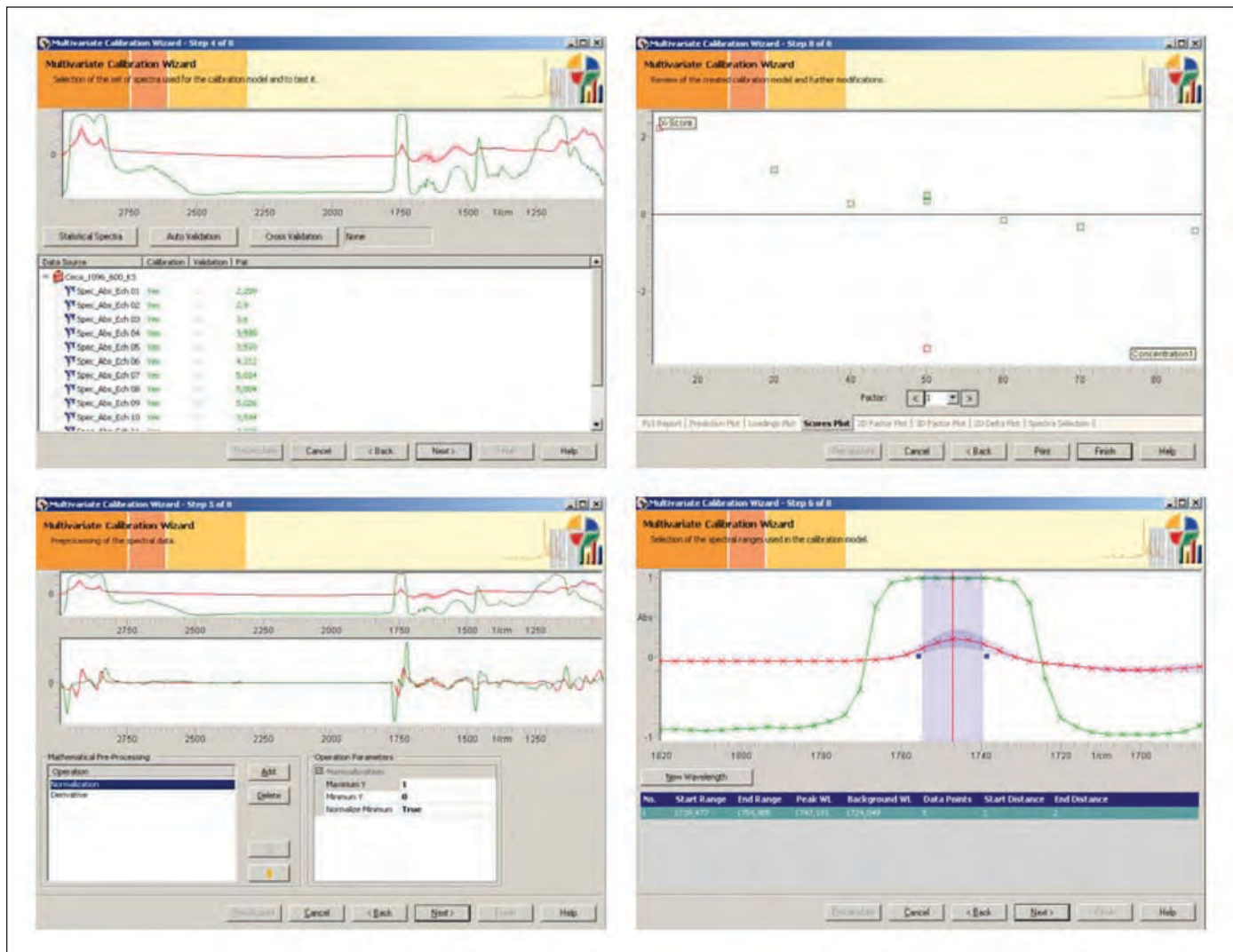
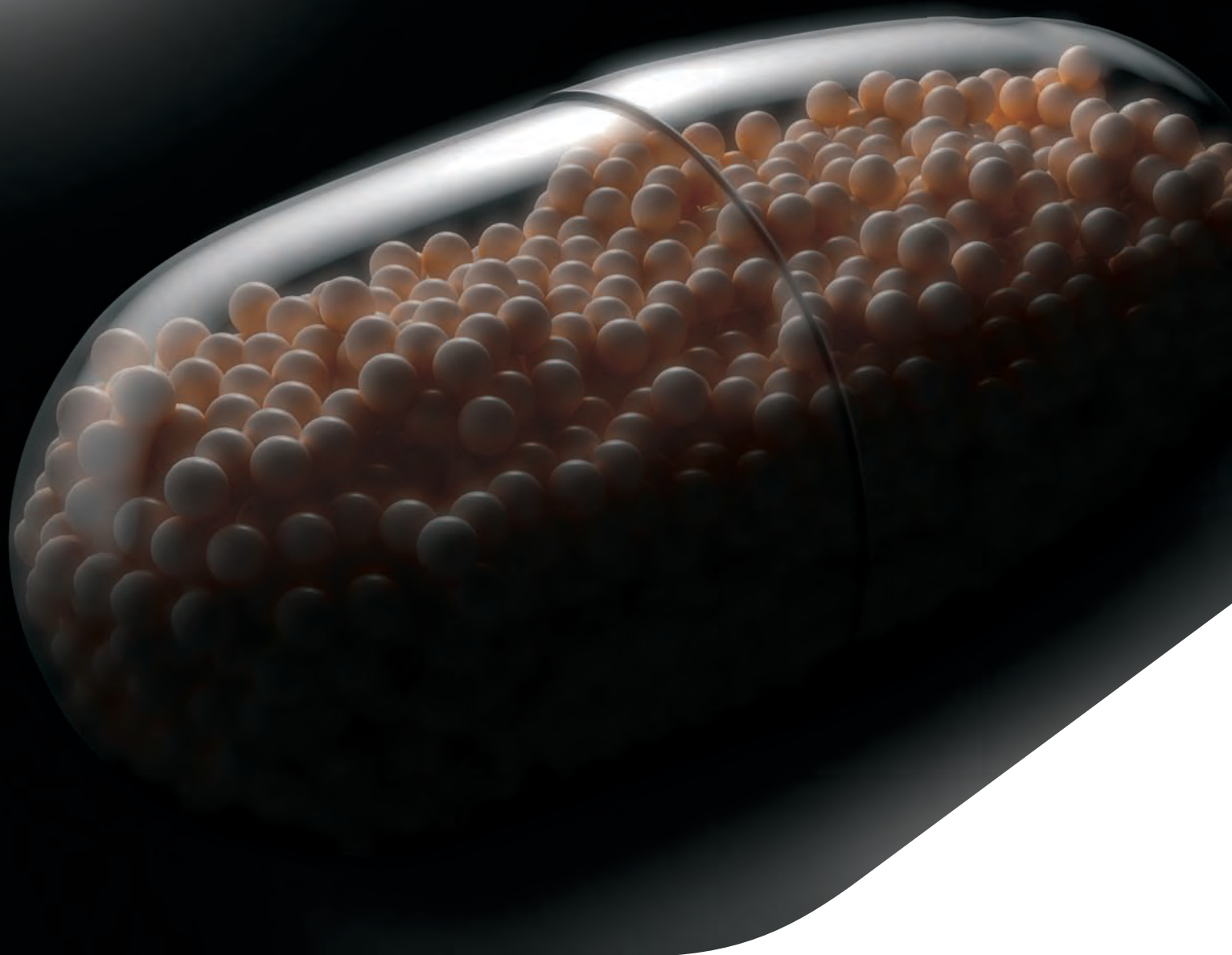

Figure 2. Example of multivariate model builder tool for data analysis.

Continued on page 28.

# The birth of a new species



Don't miss the event at **Achema 2009**

[www.ima.it/adapta](http://www.ima.it/adapta)

ACHEMA 2009

Frankfurt - May 11-15, 2009 / Halle 3.0 - Stand M2-P21

**IMA**  **ACTIVE**  
Solid Dose Solutions *division*

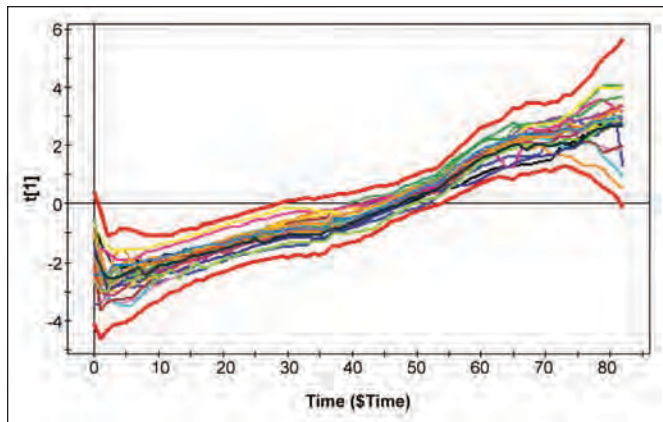

Figure 3. Example of batches that have run within their control space. (Control space graphic courtesy of Umetrics Inc.)

analyzer controller before analyzing samples. One function of the PAT data management system is to store these methods along with the audit trail confirming that this action has taken place for the lot that is preparing to run. The known method is necessary to validate the data collected from the analyzer during the lot.

When using multiple analyzers from various vendors, the complexity of managing the methods and correlating the data can grow rapidly, soon reaching a point at which it can be questioned if the results from the activity are worth the effort. Viewing the data also can be challenging when using

the different tools and formats that are delivered with the various vendor's analyzers. A PAT data management system that delivers a common format and approach for viewing the data from the various analyzers with a single tool saves time, money, and reduces mistakes. Another potential problem with combining data from multiple instruments is that the data from different types of analyzers will typically be produced over various durations and on different schedules. One analyzer may be producing results every 10 seconds, another analyzer may be producing results every 60 seconds, and the associated process control system instrumentation may be providing sample data at intervals of less than five seconds. All of this data is time stamped, but aligning all this data for use in analysis and feedback control is a critical requirement for accurate data analysis and modeling. If this time alignment of data is done manually using the time stamps, it can be very time consuming and prone to errors. Storing the data in a data management system that automatically aligns the data by time and by lot, reduces the errors from manual transcription and improves the process for using the data for real-time feedback control by ensuring that the process is being controlled using the correct data and proper calculations.

## Control System Integration for Controlling the Process

Once the scalar and spectral data is stored and time aligned

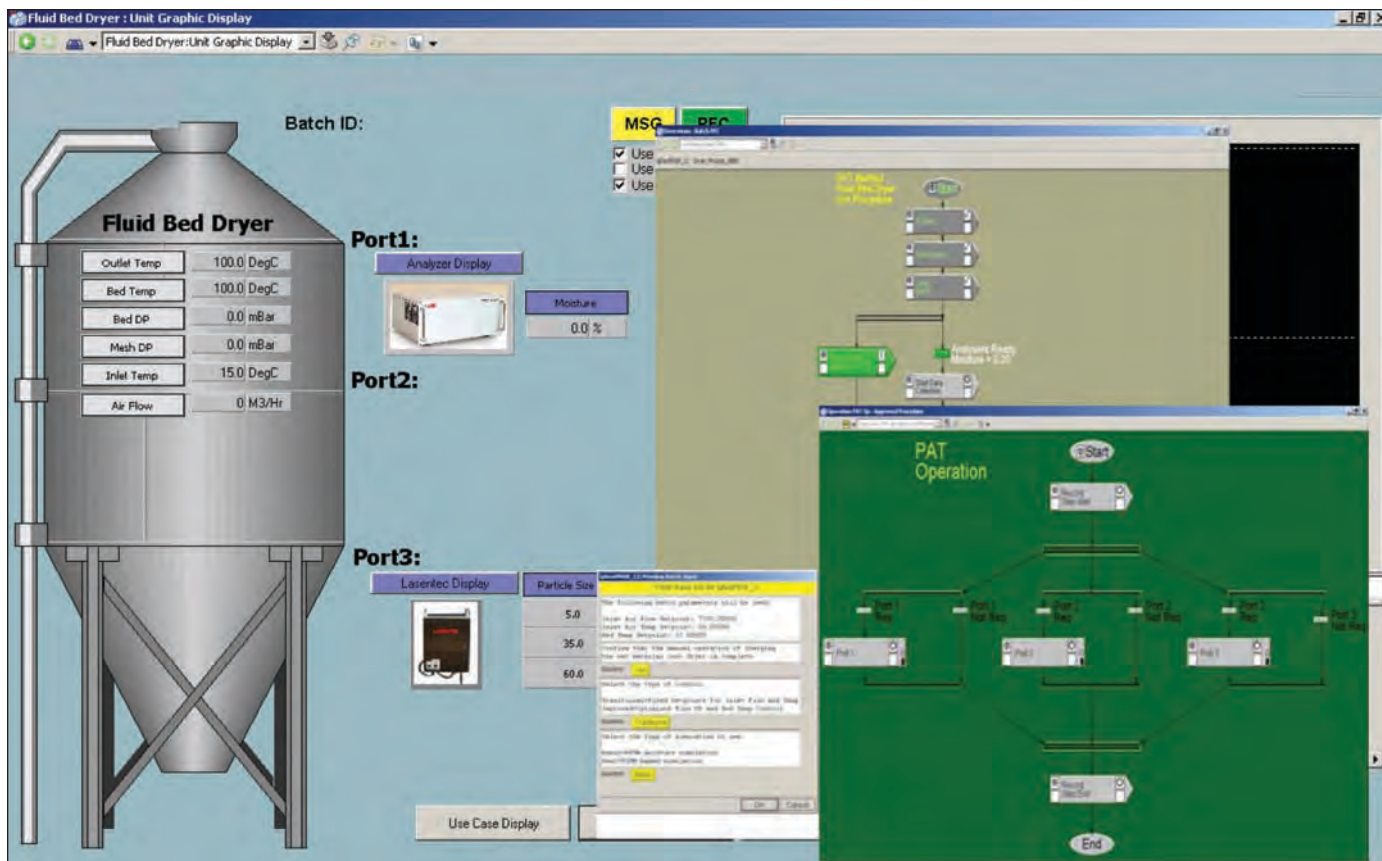

Figure 4. The graphic shows an operator control graphic with the unit procedure and the PAT method. The PAT method is embedded in the unit procedure.

in a data management system and the methods associated with the data are completed, a process model can be built using various tools available on the market. The goal of controlling the process is to identify the “control space” that defines the limit of the process system’s control capabilities and the “design space” for the process parameters that defines the limits of the process that must be observed to maintain the desired output. The goal is accomplished by measuring the CQAs and controlling the CPPs to maintain the system in a safe state, where the process parameters are well within the defined design space or window of constraint of the process. Setting up a well-managed data collection system, as mentioned above, delivers information that can be calculated from the data to provide a continuous state of monitoring and control of the process.

Visualization on the control system is used to view both the scalar and spectral data to assist operators and supervisors in defining where the process is located within the process’s “control space.” The integration of the Data Manager with the control system makes this visualization possible. This integration allows the operations staff to see the process data and its association with the CQAs that were previously defined for this process. It also allows for the monitoring and comparison of the process to that of a previously produced successful (“golden”) batch so that the exact recipe and procedure may be repeated - *Figure 3*.

Modern control systems can be configured to provide advance alarming capabilities or asset monitoring once the process is defined, modeled, monitored, and controlled. Asset monitors can take various inputs from the process and/or analyzers and record asset performance over the entire life span of the asset for comparison to a golden standard. Subsequently collected information can help managers set future performance and profitability goals. Using asset optimization programs with these asset monitors also can enable the plant to significantly reduce costly production interruptions by enabling predictive maintenance. When integrated with SMS and e-mail messaging, asset optimization provides a method for sending messages based on alarm and event information to chemometricians or application scientists via cell phones, e-mail accounts, and pagers. This process expedites the use of the data by system development personnel to improve the process.

In order to maximize flexibility for manufacturers and to have a standardized approach for this flexibility, manufacturers utilize the ISA-88 batch model to control the process. This ISA-88 model can be used for both continuous and batch processes. Even though a process is running continuously, there is a need to “track” lots of materials, utilities, and environmental and process conditions. This method allows an efficient way to do this plus optimizes date retrieval time. Using this approach increases product consistency, allows easy

*Continued on page 30.*

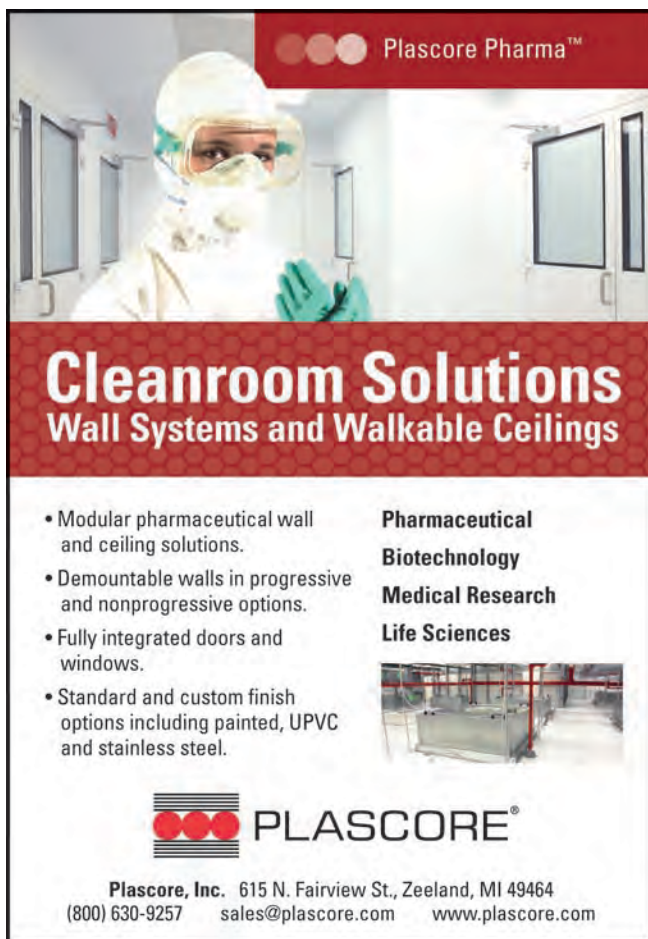

**Plascore Pharma™**

## Cleanroom Solutions

### Wall Systems and Walkable Ceilings

- Modular pharmaceutical wall and ceiling solutions.
- Demountable walls in progressive and nonprogressive options.
- Fully integrated doors and windows.
- Standard and custom finish options including painted, UPVC and stainless steel.

**Pharmaceutical  
Biotechnology  
Medical Research  
Life Sciences**



**PLASCORE®**

Plascore, Inc. 615 N. Fairview St., Zeeland, MI 49464  
(800) 630-9257 sales@plascore.com www.plascore.com



**CAL-CHEM CORPORATION**  
NOT JUST ANOTHER CONTRACTOR, BUT A PARTNER...

## “Follow Through”

“Follow Through” is critical in today’s technical market. Cal-Chem offers today’s industries solutions for a wide variety of precision cleaning and passivation, while preparing for tomorrow’s challenges.

visit our web site for more information: [www.cal-chem.com](http://www.cal-chem.com)  
or call us at:

# 800-444-6786

Offices conveniently located on the East and West Coast



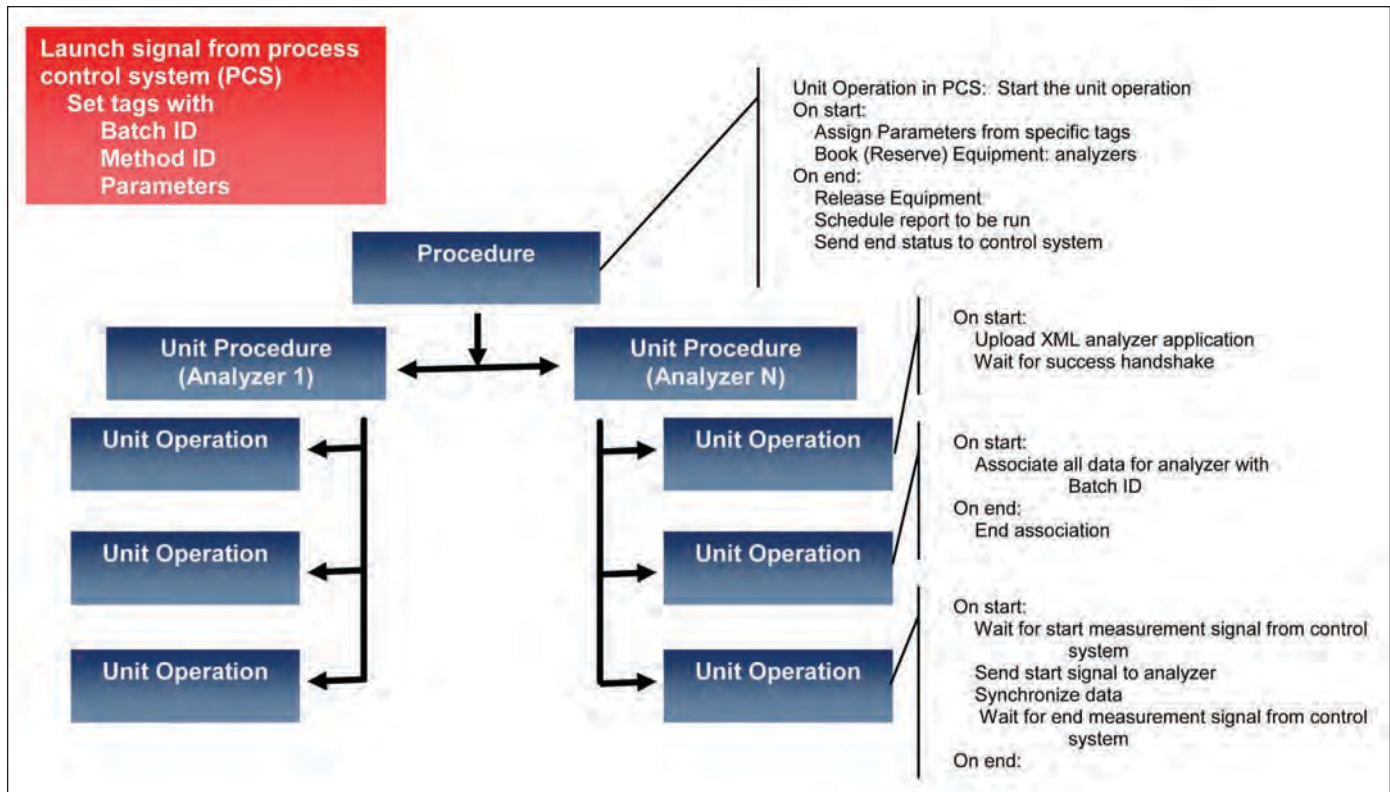

Figure 5. Example of complex PAT method in ISA-88 format.

to use recipe management operations, integrates production management functions, maximizes equipment utilization, and confirms regulatory compliance. Process batch management functions include product definition management, production execution management, production resource management, production data collection, and production dispatching.

The product definition management function includes information such as procedures, formulas, equipment requirements, and headers. This is the area of the ISA-88 model where the analyzer method can be integrated into the overall process. A procedure function chart is the graphical representation of a procedure - *Figure 4*. Each step of the procedure is displayed by a unique combination of colors and symbols.

For a process with spectrometer analyzers, there is a need to integrate the analyzer configuration step into the overall procedure. A field proven PAT method combines the analyzer configuration and batch procedure combined into one ISA-88 format file. A Process Control System (PCS) controls the execution of the PAT Method as the master control in the master/slave relationship between the control system and the PAT Method. This integration allows the control system to “book” the analyzer, download the method (parameters), confirm that the analyzer has the correct method installed, start the data collection, store the data, and end the data collection operation. Having an “end collection” operation to stop the collection of data when the process is completed reduces storage of unnecessary complex spectral data and increases the storage efficiency.

Storing the analyzer method with the lot data being collected from the analyzer eliminates any doubt as to which

method was used. All the data from the analyzers, the method(s) used, and the other process data associated with the lot (temperatures, pressures, flow, levels, pH, conductivity, TOC, etc.) will be stored in a batch folder associated with that lot that is located within the data management system. This batch record has a “software wrapper” around it that prevents changes to the data and provides easy access to the data via the system’s network or the plant or company’s intranet.

A simple PAT method is where one analyzer is used in a unit operation. A complex PAT method is where two or more analyzers are used in a unit operation or when stream switching is performed based on the product (recipe) that is being run. The modular nature of the ISA-88 format allows complex PAT methods to be easily integrated to complete the PAT solution - *Figures 5 and 6*.

An interface is required for each spectrometer analyzer integrated into the system. The communication between the system and the different analyzer components used to measure a process can be challenging. There are many different analyzers being used in the industry today, manufactured by various vendors, and using many different communication protocols integrated with many types of process control and information systems. Currently, there is no standard communication protocol for analyzers to match the standards that are available for other instrumentation, i.e., Profibus and Foundation Fieldbus. The OPC Foundation has responded to this challenge by recently starting a working group, OPC Unified Architecture – Analyzer Device Integration (OPC/UA – ADI)<sup>7</sup> to develop a standard for analyzer interfaces. Several analyzer manufacturers and end users are represented on

the team driving this effort to a standard protocol interface. In the meantime, a standard generic analyzer controller has been developed that allows all different types and brands of analyzers to communicate to the batch manager that is described above.

Completing the third step of the “learn, predict, and control” process allows the process to be continually adjusted to maintain a high level of quality based on the measured values and predictions generated in the first two steps. This is only possible after the process has been clearly understood, with all the variables known and the CQA’s reaction to changes in the system CPPs known so that it is possible to produce a product safely and efficiently by using closed loop control - *Figure 7*. Current closed loop control is set up so that the recipe management system controls the system CPPs by sending inflexible recipe setpoint parameters to the control system. With the proper PAT tools in place and properly set up, the system can monitor the process and modify the CPP values based on knowledge of the CQA’s reaction to the changes to adjust the process and keep it within the guidelines of the design space that was previously determined.

The PAT enabled control system adjusts the setpoints of the PID algorithm or phase logic that is embedded in each of the controllers to keep the process within the specifications of the design space rather than maintaining the recipe setpoint. The system continues to collect and model data from the laboratory and process analyzers (CQAs) and the process instrumentation as it is stored and time synchronized.

## Compliance with FDA Regulations

Any electronic data management application used in the life

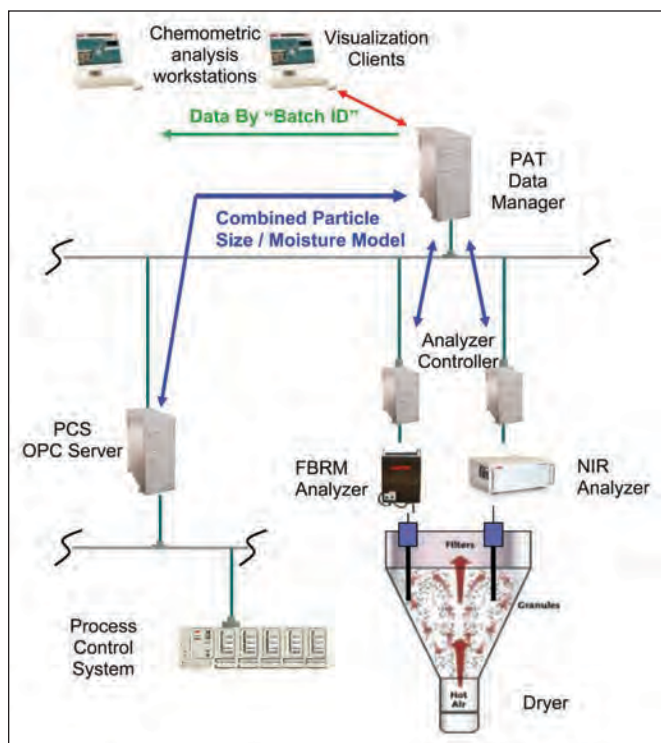

Figure 6. Example of complex data PAT solution with PAT Data Management Solution.

Continued on page 32.

Don't gamble on safety



## The safest sight glass is Metaglas®

Metaglas sight glasses are made by fusing true borosilicate glass inside a compressive metal ring. The result is glass uniquely resistant to failure and reusable after maintenance. If you're *not* using Metaglas, you're probably using the wrong type of glass and spending more on maintenance and reducing worker safety.

The #1 selling fused sight glass, Metaglas has been proven in thousands of plants. But it's L.J. Star's application experience that puts you in the winner's circle: You get the right solution and the right documentation, without the run around.

**Critical specs: USP Type I Glass, DIN 7079, DIN 7080, FM, ASME-BPE.**

**Find out why at [www.ljstar.com/SpecRite](http://www.ljstar.com/SpecRite)**



**Free Sight Glass Application Handbook**  
[www.ljstar.com/hb3](http://www.ljstar.com/hb3)

**L.J. STAR**  
INCORPORATED

**330-405-3040 • [www.ljstar.com](http://www.ljstar.com)**

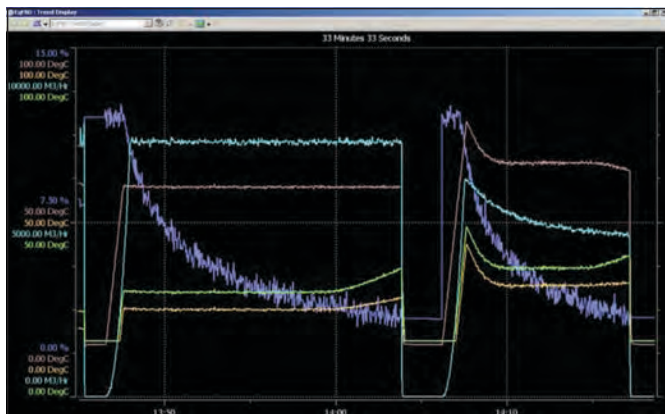

Figure 7. Trend display shows time elapsed during runs of a dryer, the first one without advanced model control, the second one with advanced model control.

science industry for GMP operation in a pilot plant or manufacturing facility must comply with the FDA requirement 21 CFR Part 11.<sup>8</sup> This regulation defines the use of electronic records and electronic signatures in the industry, including the role of validation, time stamps, copies of records, and record retention in the regulation. There are a number of software applications on the market today that can perform portions of complete PAT data management solution; however, each portion must comply with the applicable FDA predicate rule and 21 CFR Part 11, and the overall system also must comply. A system approach to PAT data management is the preferred approach due to ease of compliance, reduced cost of validation, single source responsibility of the supplier, ease of updates and upgrades, and the reduce cost of implementation.

Ease of validation is one of the major advantages of using a single system approach to data management. A system that uses a single database for data collection and data and metadata storage can be validated more easily than a system composed of multiple databases and software packages that have been integrated on a project-by-project basis. A system with multiple databases will have multiple interfaces, and each of these interfaces have to be qualified. Using today's technology to develop a single system that controls multiple classes of analyzers, performs data collection and data calculation functions, and has interfaces to external information technology and control systems can realize a significant savings in the cost and time spent validating the installation. This modular validation effort allows the reuse of the validation for the R&D and pilot plant applications in the manufacturing sites without extensive revalidation; a quick installation verification is all that is required to qualify the reused method. It also is possible to use analyzers that allow transfer (reuse) of calibrations between individual devices due to their tight manufacturing specifications.

## Benefits

There is no lack of information concerning the savings associated with using PAT. The petrochemical, pulp and paper, and electronics industries have been doing this type of automated adjustments to the processes for many years. Recently, the FDA

has asked the life sciences industry to perform the same process control. In addition, a series of guidance documents have been created by global regulators, including "Pharmaceutical cGMPs for the 21st Century," "PAT Initiative Framework," and "ICH Q8," as well as a renewed interface with industry groups such as ISPE, PDA, and IFPAC.

The ISPE PAT Community of Practice (COP) has a discussion thread on the ISPE Web site that contains various benefits from using PAT, including:

- better understanding of the process
- increased reproducibility from batch to batch
- reduced process risk
- reduced validation and revalidation effort
- reduction of scrap
- higher throughput

Using PAT is not limited to the manufacturing area. A complete PAT plan should include its use in R&D and pilot plant areas as well as in the manufacturing area. Ideally, PAT principles and tools should be introduced during the development phase.<sup>9</sup> The process understanding gained during the development phase of the product, including an understanding of process changes due to variables and raw material changes, can be transferred to pilot plant and manufacturing areas. This will allow the user to maximize these process benefits as they progress through scale up, testing, validation, and manufacturing phases.

With an integrated PAT data management program, qualified PAT methods can be transferred from one facility to another for identical processes. With some analyzers on the market, this also can include the calibrations of those analyzers.

## Summary

Advances in process analyzers and PAT data management systems make it possible to perform real time process control and online quality assurance during the R&D, pilot, and manufacturing phases of a product. This discussion covered several topics and various areas of a typical facility and the multiple disciplines needed to fully implement a PAT closed loop control system that delivers the most desired benefits. Storing data in a format and method that supports PAT implementation and use is not a simple task.

This discussion identifies that it is most useful when the PAT solution can be found in a single, scalable solution that interfaces with multiple types of analyzers, historians, and control systems, can support time synchronization, and store the PAT methods and data in a single batch file following an ISA-88 format that is compliant with current FDA regulations. A comprehensive PAT data management system must be in place to fully realize the benefits available from a full service PAT offering.

A PAT data management solution gives the user all the tools necessary for a PAT project. The results from a correctly set up PAT data management system allow understanding and optimization of the process. Having a system to provide

*Concludes on page 34.*



# True Sterile Connections **OUTSIDE** THE CLEAN ROOM<sup>SM</sup>



Patent Pending

## Pure-Fit<sup>TM</sup> SC

[www.biopharm.saint-gobain.com/true2](http://www.biopharm.saint-gobain.com/true2)

- A silicone valve design that avoids problems with paper pull-out systems (residual material in fluid path, gaps when paper is removed)
- Patented Pure-Fit<sup>®</sup> SIB<sup>®</sup> technology on barb connections to ensure a completely smooth inner bore flow path
- Ease of assembly
- A triple-redundant locking mechanism that virtually eliminates operator error

*Pure-Fit<sup>®</sup> and SIB<sup>®</sup> are registered trademarks.*

For more information on Pure-Fit<sup>®</sup> SC, visit [www.biopharm.saint-gobain.com/true2](http://www.biopharm.saint-gobain.com/true2) or call (800) 530-3419.

  
SAINT-GOBAIN  
PERFORMANCE PLASTICS

a common user interface and common method development tool for different types of analyzers enhances usability while reducing the system's training and long-term support costs.

Once the PAT data management solution is in place, the user will be able to understand where their process is within the control space and will be able to control it within the necessary limits. A fourth phase of a PAT project then can be added – continuous learning and optimization of the process based on the data. This understanding and optimization can result in increased yields and throughput, and reduce costs to support the ultimate goal in manufacturing: Real-Time Product Release (RTPR). All of these functions must be accomplished using software that can be configured to meet FDA regulations.

The FDA states that Real-Time Product Release can be enabled by PAT:

*“real time release is the ability to evaluate and ensure the acceptable quality of in-process and / or final product based on process data. Typically, the PAT component of real time release includes a valid combination of assessed material attributes and process controls. Material attributes can be assessed using direct and / or indirect process analytical methods. The combined process measurements and other test data gathered during the manufacturing process can serve as the basis for real time release of the final product and would demonstrate that each batch conforms to established regulatory quality attributes. We [FDA] consider real time release to be comparable to alternative analytical procedures for final product release.”<sup>10</sup>*

## References

1. Process Analytical Technology (PAT) is a system for designing, analyzing, and controlling manufacturing through timely measurements (i.e., during processing) of critical quality and performance attributes of raw and in-process materials and processes with a goal of ensuring final product quality as defined by Guidance for Industry PAT – A Framework for Innovative Pharmaceutical Development, Manufacturing, and Quality Assurance, FDA September 2004, <http://www.fda.gov/Cder/guidance/6419fnl.pdf>.
2. Wilhelm, R., Know Your Types of Standards, ASTM Standardization News, October 2000. Test Method – A definitive procedure that produces test result. A test method usually includes a concise description of an orderly procedure for determining a property or constituent of a material, an assembly of materials or a product. All details regarding apparatus, test specimen, procedure, and calculations needed to achieve satisfactory precision and bias should be included in a test method. An ASTM test method should represent a consensus as to the best currently available test procedure for use intended and it should be supported by experience and adequate data obtained from cooperative tests. Examples of test methods included, but are not

limited to: identification, measurement, and evaluation of one or more qualities, characteristics or properties.

3. Buijs, T., “Process Analytical Technology: Integrated PAT solutions for the Life Sciences Industry,” ABB Review.
4. Guidance for Industry, Part 11, Electronic Records, Electronic Signatures – Scope and Application, FDA August 2003, <http://www.fda.gov/cder/guidance/5667fnl.pdf>.
5. Horizon MBTM FTIR Software User Manual (ABB May 2007).
6. ISA-88.01-1995 (R2006); Batch Control Part 1: Models and Terminology (ISA 2006), <http://www.isa.org/Template.cfm?Section=Standards8&Template=/customsource/isa/Standards/StandardsListing.cfm>.
7. OPC Foundation Announces Support for Analyzer Devices Integration into OPC Unified Architecture Platform (OPC Foundation, 12 January 2008, <http://www.opcfoundation.org/Search.aspx>).
8. Guidance for Industry, Part 11, Electronic Records, Electronic Signatures – Scope and Application, FDA August 2003, <http://www.fda.gov/cder/guidance/5667fnl.pdf>.
9. Guidance for Industry PAT – A Framework for Innovative Pharmaceutical Development, Manufacturing, and Quality Assurance, FDA September 2004, p. 13, <http://www.fda.gov/Cder/guidance/6419fnl.pdf>.
10. Guidance for Industry PAT – A Framework for Innovative Pharmaceutical Development, Manufacturing, and Quality Assurance, FDA September 2004, p. 12, <http://www.fda.gov/Cder/guidance/6419fnl.pdf>.

## About the Author



Mark Reed has more than 27 years of experience in automation system sales and design for pharmaceutical, biotech, chemical, and other industrial facilities. For the last 24 years, Reed has worked for ABB Inc. (previously Taylor Instrument and Combustion Engineering) as a Principal Account Manager specializing in automation systems for the life sciences and chemical industries. ABB is one of the world's largest suppliers of process automation and building management systems, PAT, drives, robotics, analytics, instruments, and project services to the Life Sciences industry. Combining world-class products with deep application and industry experience, ABB helps customers achieve higher levels of operating efficiency, quality, and compliance. Reed has been actively involved with the successful introduction and sales of each of ABB's automation systems. Currently, he works with ABB's PAT Data Manager product and process analyzers to assist companies in realizing the benefits of using PAT and process analyzers. He graduated with a BS in chemical engineering from North Carolina State University in 1981. He is a member of ISPE and ISA. He can be contacted by telephone: +1-404-281-3543 or by email: [mark.reed@us.abb.com](mailto:mark.reed@us.abb.com).

ABB Inc., 940 Main Campus Dr., Suite 500, Raleigh, North Carolina 27606, USA. 

Need Knowledge? No Budget for Travel?



## No Problem.

ISPE Online Learning delivers critical knowledge and training to you anytime, anywhere, and at a price to fit your budget.

Go to [www.ISPE.org/onlinelearning](http://www.ISPE.org/onlinelearning) for a complete list of Web-based learning opportunities or call ISPE Member Services at tel: [+1-813-960-2105](tel:+1-813-960-2105).



This article presents the transfer of a freeze-drying process from a glass bottle to a freeze-drying tray.

## Considerations for Transferring a Bulk Freeze-Drying Process from a Glass Container to a Tray

by Yves Mayeresse, Vinciane de Cupere, Romain Veillon, and Joseph Brendle

### Introduction

**F**reeze-drying, a leading drying technology, is widely used in the biopharmaceutical industry to stabilize products.<sup>1</sup> Although it is predominantly used for the storage of active ingredients before reconstitution into a final formulation, it also may be useful for some stages of intermediate production, such as Active Pharmaceutical Ingredient (API) operations.

A freeze-drying cycle may be divided into three stages.<sup>2,3</sup> First, the product is frozen at a sufficiently low temperature to reach a vitreous state where pure water has crystallized and the amorphous content remains in the interstitial region. In the second stage, the product undergoes sublimation at a temperature below the glass transition or collapse temperatures and crystallized water is sublimated. Finally, secondary drying is undertaken at a higher temperature to remove sorbed water from the interstitial region.

Maintenance of correct temperatures throughout the whole process is essential. Indeed, if the product temperature rises above the collapse temperature<sup>1</sup> (maximum temperature allowed during the freeze-drying process to keep

physical structure integrity of the cake), the product viscosity is lowered and an irreversible melting may occur.

Such a collapse can result in the rejection of a partial or total batch.

Initial freezing of the product involves two steps: ice nucleation followed by ice crystal growth. Once the solidification temperature is reached, all other elements of the formulation are typically rendered an amorphous solid.

The sublimation phase is an endothermic process which is controlled predominantly by shelf temperature and chamber pressure. Numerous other factors (such as container heat transfer coefficient, container geometry, stopper design, freeze-dryer geometry, freezing behavior, fill depth, formulation type and concentration, and the robustness of the filling process) also are important and together contribute to the product temperature at the interface where the water crystals sublimate. The product temperature is kept below collapse temperature with a safety margin during the whole cycle. At the end of this stage, products with conforming visual aspect and homogeneous moisture content are obtained. The high number of parameters influencing this process explains why it is so difficult

Figure 1. Product weight profile during freeze-drying using a microbalance, at the end of primary drying (48 hours), moisture content is 12%, at the end of secondary drying (60 hours), moisture content is 1.3%.

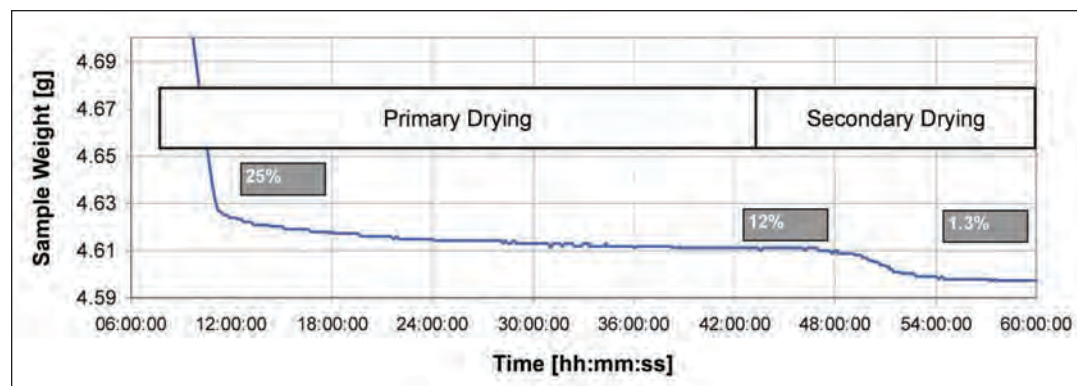

Continued on page 38.

Work continued from Page

Freeze-drying = open system  
ICH Q7A → closed better than open  
Is there a way to do closed freeze-drying?

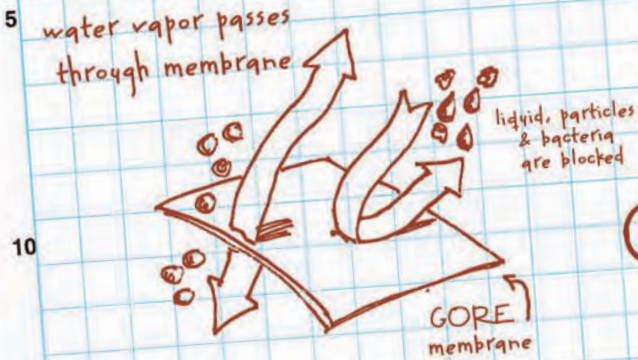

-Engineering controls  
-Sterile API

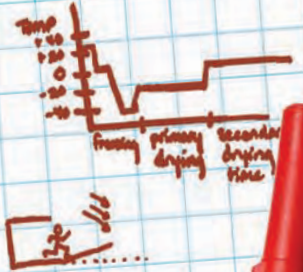

10



1050.002 F  
1050.002M

15

$$\frac{dm}{dt} = \frac{(P_0 - P_1)}{(R_p + R_m)}$$

$$\frac{dQ}{dt} = A \Delta T_o P (T_0 - T_p)$$

Increased area = increased heat transfer



20

Single use solution for freeze-drying.

LyoGuard

25

### Why can't an open system be... closed?

Freeze drying systems are traditionally open. But GORE™ LYOGUARD® freeze drying products are closed. How? Our patented membrane material can breathe. So this closed system contains your product, cutting down risks of product contamination and cross contamination. Worker safety is improved, and yields are increased due to minimal product loss and optimized operations. And the single use product form reduces cleaning and cleaning validation. Open and closed. So you can pursue your boldest innovations. Find out more at [gore.com/pharmbio](http://gore.com/pharmbio).

30

Gore PharmBIO Products

Tubing. Membranes. Filtration. Creativity.

Work continued to Page

35

DATE

SIGNATURE

DATE

WITNESS

DISCLOSED TO AND UNDERSTOOD BY





Figure 2. One liter glass bottle after freeze-drying with a fill weight of 400ml.

to model the freeze-drying process. After primary drying, 10 to 20% water remains adsorbed on the active ingredient within the formulation. Therefore, a secondary drying step, often called desorption, is undertaken to remove this bound water - *Figure 1*.

During this phase, the shelf temperature ramp needs to be well designed to avoid local product collapse and shrinkage as a result of local overheating. However, once the plateau is reached, the product is maintained at this positive temperature for several hours to obtain the right residual moisture level. At this stage, water removal is achieved by diffusion, rather than sublimation. Since diffusion kinetics is slower, the secondary drying may take up to one third of the entire process duration, despite only removing 10 to 20% of the total water. The maximum temperature for secondary drying is defined by the function of the ultimate product; however, for biopharmaceutical molecules, it usually remains below +40°C.

Cycle optimization is undertaken to design a cycle with the highest allowed product temperature and sufficient safety margins, such that despite any variations, the product will be maintained within proven acceptable limits. In the past, freeze-drying cycle optimization mainly consisted of a trial and error approach, until a satisfying cycle was reached. Today, a process evaluation and validation approach is used. Evaluation of the freeze-drying process is initially undertaken and considers composition description, glass transition studies, and the lyophilization cycle time. The critical parameters (e.g., shelf temperature) are then established, quality attributes are described (i.e., potency, residual solvent, humidity) and the proven acceptance range is set (i.e., shelf temperature  $\pm 3^\circ\text{C}$  or  $\pm 5^\circ\text{C}$ ). Finally, validation of the proven acceptance range is accomplished (input parameters) by measuring the quality attributes (output parameters).

Mapping industrial equipment operational capabilities (i.e., ice condenser capacity) also is critical in order to evaluate potential process limitations during scaling up. Another factor that needs to be taken into account is the scheduling of the manufacturing operations. For example, there is no need to design a cycle that stops at 3:00 am when working scheduling is not in three shifts. Indeed, an integrated approach to take into account both scientific and business needs to be adopted.

The global process concerns an intermediary of production that does not need to be filled in aseptic condition. After freeze-drying, the membrane trays are readily transferred in a glove box with controlled humidity. Then the content of the membrane trays are transferred in glass bottle for long term storage.

Traditionally, we have performed our freeze-drying cycles in 1 liter glass bottles. We describe here a feasibility study which was undertaken to evaluate the compatibility of ePTFE



Figure 3. Membrane tray used for freeze-drying with a fill weight of 1.7L

membrane trays with our water and organic solvents formulation. We used our preliminary results as the starting point for developing a new freeze-drying cycle adapted to a membrane tray and a different freeze-dryer. Single-use ePTFE membrane trays were selected instead of more traditional stainless steel trays for several reasons including: eliminating the need for cleaning and cleaning validation of re-usable trays and reduced product fly-out. However, the process transfer principles described here also could be applied to stainless steel trays with proper adjustments in the calculations.

## Materials and Methods

The main equipment used in the processes were: 1 liter glass bottles (Figure 2), membrane trays (Figure 3), and three different freeze-dryers.

### Non-Optimized Process Evaluation

Our traditional freeze-drying process, which was undertaken in 1 liter glass bottles with a fill volume of 400 ml, was first characterized according to freezing time, primary drying cycle length, and glass integrity.

### Cryomicroscopy

Cryomicroscopic studies were performed at different freezing speeds (0.5; 1.0; 5-10°C/min) to evaluate the best freezing rate conditions for our product. In our study, the presence of the organic solvent in the formulation induced unusual crystal shapes and sizes - *Figure 4*.

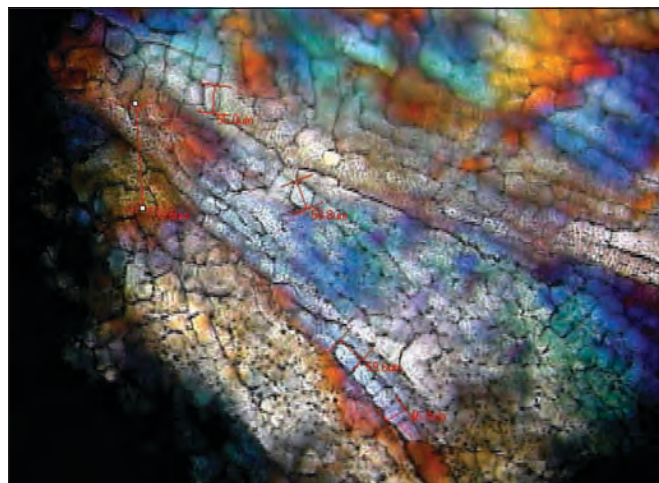

Figure 4. Freezing study using cryomicroscopy to evaluate ice crystal size in relation to freezing rate.

*Continued on page 40.*

# Intelligen Suite

The Market-Leading Engineering Suite for Modeling, Evaluation, Scheduling, and Debottlenecking of Single & Multi-Product Facilities

## SuperPro

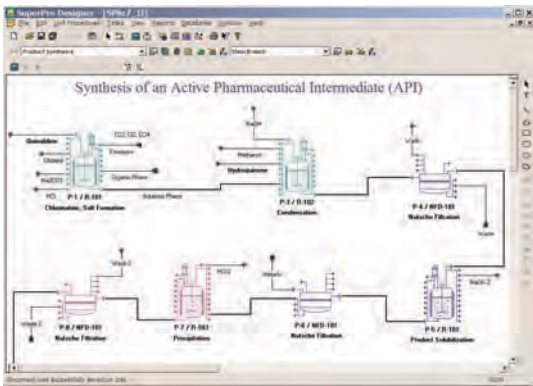

## SchedulePro

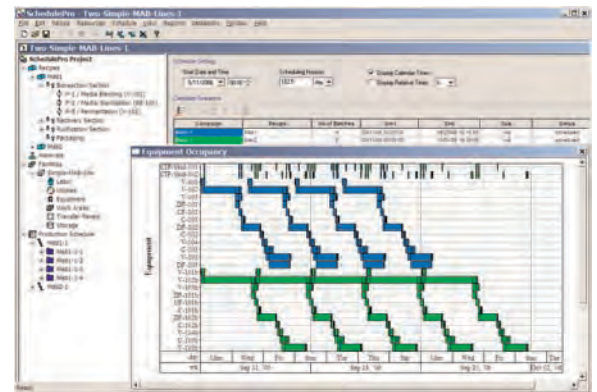

Use SuperPro Designer to model, evaluate, and debottleneck batch and continuous processes

Switch to SchedulePro to schedule, model, and debottleneck multi-product facilities



Tracking of equipment occupancy in multi-product facilities

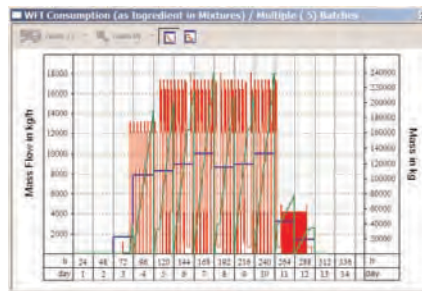

Tracking demand for resources (e.g., labor, materials, utilities, etc.)

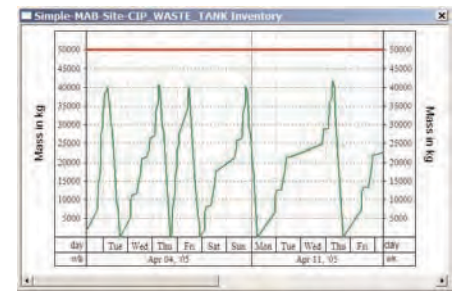

Inventory tracking for raw materials, intermediates, products, and wastes

**SuperPro Designer** is a comprehensive process simulator that facilitates modeling, cost analysis, debottlenecking, cycle time reduction, and environmental impact assessment of biochemical, specialty chemical, pharmaceutical (bulk & fine), food, consumer product, mineral processing, water purification, wastewater treatment, and related processes. Its development was initiated at the Massachusetts Institute of Technology (MIT). SuperPro is already in use at more than 400 companies and 500 universities around the world (including 18 of the top 20 pharmaceutical companies and 9 of the top 10 biopharmaceutical companies).

**SchedulePro** is a versatile finite capacity scheduling tool that generates feasible production schedules for multi-product facilities that do not violate constraints related to the limited availability of facilities, equipment, resources and work areas. It can be used in conjunction with SuperPro (by importing its recipes) or independently (by creating recipes directly in SchedulePro). Any industry that manufactures multiple products by sharing production lines and resources can benefit from the use of SchedulePro. Engineering companies use it as a modeling tool to size utilities for batch plants, identify equipment requirements, reduce cycle times, and debottleneck facilities.

**Visit our website to download detailed product literature and functional evaluation versions of our tools**

**INTELLIGEN, INC. • 2326 Morse Avenue • Scotch Plains, NJ 07076 • USA**

**Tel: (908) 654-0088 • Fax: (908) 654-3866**

**Email: [info@intelligen.com](mailto:info@intelligen.com) • Website: [www.intelligen.com](http://www.intelligen.com)**

**Intelligen also has offices in Europe and representatives in countries around the world**

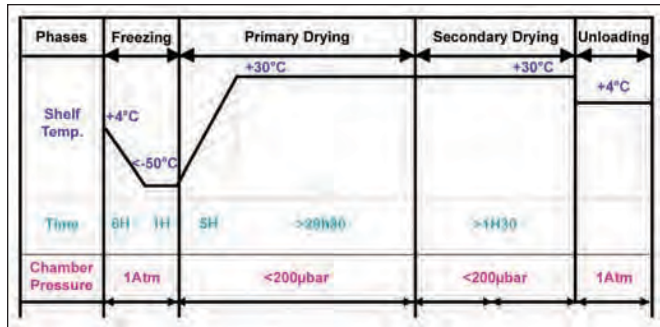

Figure 5. Lyophilization Cycle A - in blue, the temperature cycle, in pink, pressure cycle.

In contrast to normal observations, water crystal size decreased during slow freezing and increased during quick freezing. These findings influenced the selection of the lyophilization cycles during new process evaluation.

## New Process Evaluation Membrane Trays

In order to validate the compatibility of the membrane tray in the presence of an organic solvent, extractible and leachable studies were performed following USP and EP guidelines.

### Lyophilization Cycles

Early lyophilization cycles using membrane trays were developed for a total load of 20 liters and process duration of approximately two days. As a result of the cryomicroscopic studies, the freezing step involved the introduction of the membrane tray at 0°C and slow freezing down to -50°C over six hours, to allow for the formation of smaller crystals. Two cycles were evaluated:

#### Cycle A

The membrane tray was introduced at 0°C and held at this temperature for sufficient time to allow the product temperature to equilibrate. Slow cooling was undertaken at a rate below 0.5°C per minute until the temperature reached at least -45°C. The shelf temperature was ramped to a maximum of +30°C over five hours at a pressure below 200 µbars and was held under these conditions for 29 hours and 30 minutes. The total cycle duration was at least 43 hours - *Figure 5*.

Several problems were encountered with cycle A. First, the membrane trays inflated during the course of lyophilization, particularly at the beginning of the sublimation step. This attributed to excessive vapor flux affecting membrane permeability. Second, long strips of wet powder were observed at the bottom of the cake, at the end of lyophilization, indicating that large ice crystals had formed during freezing step and that sublimation was not complete.

In order to avoid the formation of large ice crystals and to slow down the sublimation event, the freezing time was reduced by introducing the sample directly onto a pre-cooled shelf, the primary drying temperature was decreased, but the duration increased and a secondary drying phase was introduced.

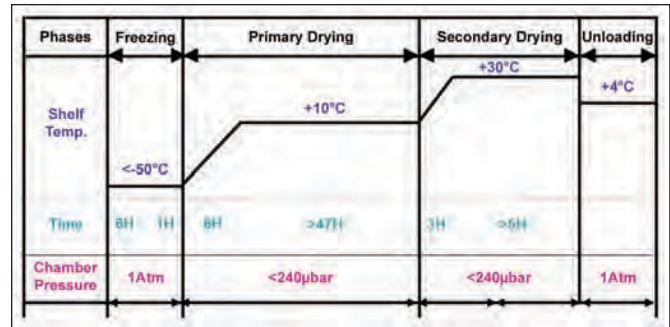

Figure 6. Lyophilization Cycle B - in blue, the temperature cycle, in pink, pressure cycle.

#### Cycle B

The membrane tray was introduced onto a pre-cooled shelf below -45°C and held at this temperature for five hours. The shelf temperature was ramped from -50°C to +10°C over six hours with vacuum controlled at a setpoint below 240 µbars. The shelf temperature was held for at least 47 hours at a maximum of +10°C and a pressure below 240 µbars. Secondary drying was undertaken by ramping from +10°C to maximum +30°C over three hours at a pressure below 240 µbars and holding under these conditions for at least five hours. The total duration of the cycle was 67 hours - *Figure 6*.

#### Validation

The reproducibility and robustness of the lyophilization process were tested by subjecting one batch of product to five different lyophilization cycles, comprising three standard cycles of process b for reproducibility and two extreme cases for robustness.<sup>5</sup> The extreme cases comprised faster drying (target pressure +20%; target temperature +5°C; duration 54 hours) and slower drying (target pressure -20%; target temperature -5°C; duration 40 hours). The different lyophilization cycles were compared by analyzing the organic solvent and residual water content of the end product.

#### Product Homogeneity

As the condensers are situated in the lyophilization chamber,

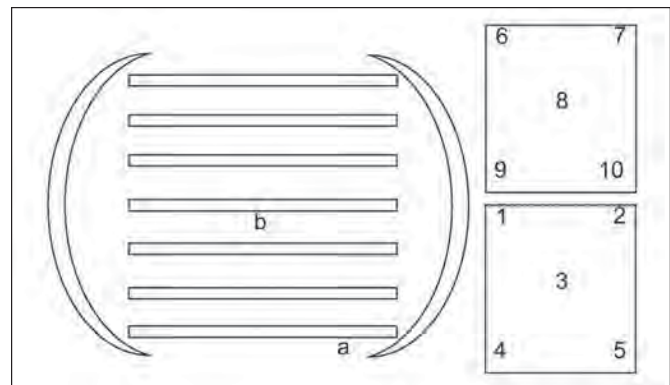

Figure 7. Description of the samples taken in order to determine the homogeneity of the bulk produced in one lyophilization cycle. Position of the membrane trays in the freeze-drying chamber: on first shelf next to the condenser (membrane tray a); on the middle of the fourth shelf (membrane tray b). Sample points in each membrane tray (1 to 10).

*Continued on page 42.*





# In safe hands

## Containment Solutions for the Pharmaceutical & Biotech Industries

- Barrier Isolation Systems
- Downflow Containment Booths
- High Containment Screens
- Pack Off and Process Equipment
- Kilo Labs & Glassware Enclosures



For further information please contact us on

North America

502 968 2065

Rest of the World

+44 (0) 1204 571131

[info@howorthgroup.com](mailto:info@howorthgroup.com)

[www.howorthgroup.com](http://www.howorthgroup.com)

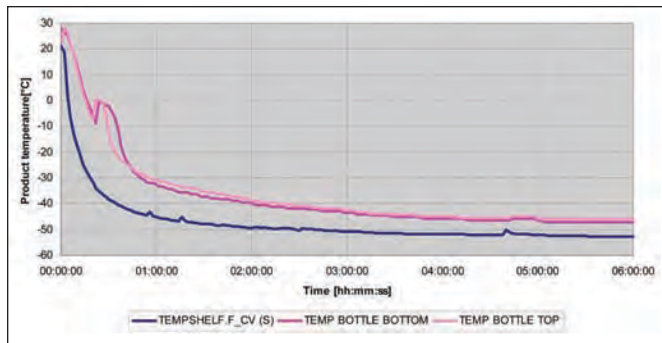

Figure 8. Product temperature profile during freezing in large bottles.

radiation may induce a temperature gradient from chamber center to its periphery, which may ultimately cause water and organic solvent content heterogeneity within the lyophilized cake. In order to test for homogeneity, samples from a single batch were removed from membrane trays placed on the lowest and middle shelves of the lyophilization chamber (i.e., closest to the condenser at the coolest part and at the warmest part of the chamber, respectively - *Figure 7*).

## Freezing Conditions

The effects of rapid and slow freezing were compared on the same bulk by loading parts of the lot on freeze-dryer shelves at two different temperatures (0°C and -45°C). The end products were analyzed with respect to organic solvent content, using a moisture testing device, and product particle size.

## Results

### Non-Optimized Process Evaluation

#### Freezing Time

The freezing process in large bottles on pre-cooled shelves was long; taking two and six hours to reach -40°C and -45°C, respectively - *Figure 8*.

This extended freezing time was predominantly due to bottle geometry, which results in a poor capacity for the first ice layer to dissipate the water crystallization exotherm.

#### Primary Drying Cycle Length

The freeze-drying cycle time using glass bottles was 160 hours - *Figure 9*. The product temperature from the vial bottom reached positive temperature after 140 hours indicating the end of the sublimation endotherm.

#### Glass Integrity – Lensing

When a product is freeze-dried in large bottles, there is a tendency for the bottle bottom to weaken as a result of freezing and subsequent ice expansion, resulting in a lens shaped fracture. During stoppering, the fragile glass released tension by cracking or fully breaking in a lens shape.

### New Process Evaluation

#### Membrane Trays

An analysis of the leachable and extractables studies done following the USP and EP guidelines showed that the trays were suitable for this application. This portion of the new

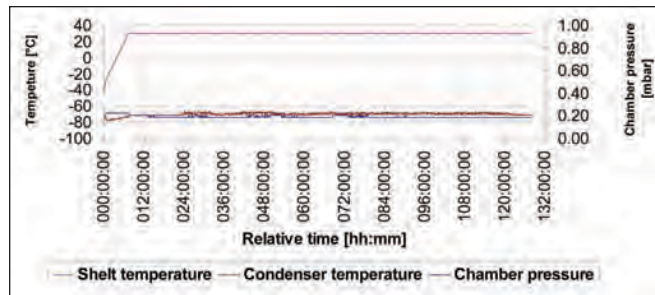

Figure 9. Freeze-drying process recording during a week cycle with large bottles, the shelf temperature is in pink, the condenser in brown, and the pressure in blue.

container validation was a time consuming process, taking over 200 working hours.

## Lyophilization Cycles

### Cycle A

As seen from the temperature recordings, at the end of the primary drying phase (after 42 hours), the cake temperature did not reach a plateau approximating to shelf temperature - *Figure 10*.

In addition, there was a discrepancy between the target chamber pressure and the effective pressure, indicative of excessive vapor flux at the beginning of the sublimation process.

### Cycle B

As seen in *Figure 11*, the sample temperature reached a plateau before the end of the primary drying sequence, indicating that the ice had been completely sublimated out of the sample before the secondary drying sequence commenced. In addition, there was no discrepancy between the set-up and real chamber pressure measurements. No membrane tray inflation was observed using this cycle.

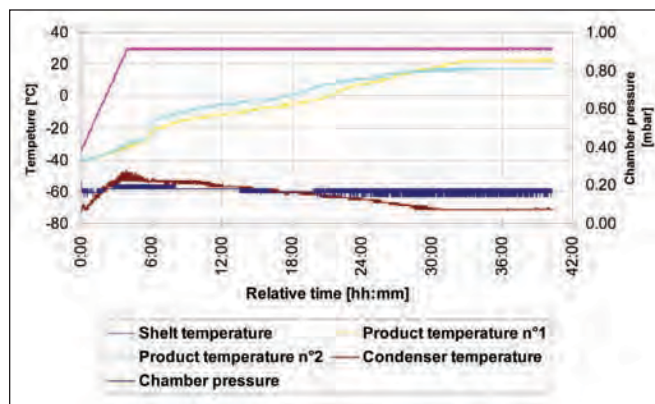

Figure 10. Lyophilization cycles (a). In pink, shelf temperature; in yellow and blue, the measured sample temperature (at the middle and at the top of the cake); in dark blue, the measured pressure, in brown, the measured condenser temperature. During lyophilization cycles illustrated in A, sample temperature hardly reached a plateau value after 42 hours, indicating that lyophilization was not completely finished (primary drying: OK, secondary drying: absent). During the lyophilization cycle illustrated in 14b, real pressure value was higher than the set value. This indicates an excessive vapor flux, at least during the first 10 hours of the primary drying.

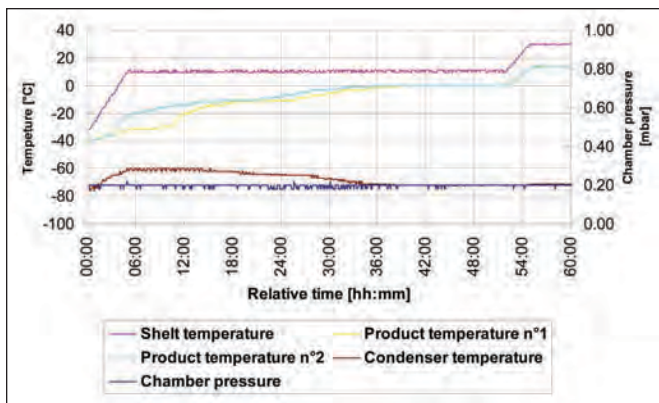

Figure 11. Lyophilization cycles (b). In pink, shelf temperature; in yellow and blue, the measured sample temperature (at the middle and at the top of the cake); in dark blue, the measured pressure, in brown, the measured condenser temperature.

## Validation

The residual water content for the three reproducibility lots was identical (5.3%) - Table A. The values were slightly higher after slower and faster drying, respectively (5.7% and 5.2%).

The organic solvent contents were within specification after all processes, illustrating process robustness. Both the improved and standard drying cycles provided the same results for organic solvent content, indicating that the drying process is complete (i.e., no more free organic solvent in the

	Sample	Res. Sol. wt%	Water wt%
repro	Pool 9/41/RO	5.3	3.7
	Pool 9/41/RO run2	5.3	4.45
	Pool 9/41/RO run3	5.3	4.62
worst case (dry)	Pool 9/41/RO-run 4	5.2	4.22
worst case (wet)	Pool 9/41/RO-run 5	5.7	4.17

Table A. Results of validation in terms of water content and residual solvent.

bulk) after the standard cycle. Any remaining organic solvent in the product is present in product salt.

## Product Homogeneity

Organic solvent and water content were consistent in both membrane trays, irrespective of their position in the lyophilization chamber (Table B), indicating that the lyophilization process is homogeneous, and allowing for random quality control sampling from any of the membrane trays.

## Freezing Conditions

Irrespective of the shelf temperature, both samples displayed organic solvent content of 5.6% and KF values ranged from 0.8 to 0.9 %. The product particles size distribution showed that there was no significant difference between the two samples. The particle size distribution is described for both

*Continued on page 44.*



ARCHITECTURE  
ENGINEERING  
CONSTRUCTION

SINGLE SOURCE RESPONSIBILITY

## From Benchtop to Distribution

### We Understand Your GxP Facilities.



Research  
API  
Manufacturing  
Finishing  
Support



8 Ridgedale Avenue, Cedar Knolls, NJ 07927 – 973-775-7777  
Contact: [guy\\_cipriano@eiassociates.com](mailto:guy_cipriano@eiassociates.com) – ext. 378



## DELABELING SOLUTIONS

for

- SYRINGES\*
- CARTRIDGES
- GLASS VIALS
- PLASTIC VIALS
- METAL CANISTERS

\*new 2009

Information:  
[www.hurstcorp.com](http://www.hurstcorp.com)

**Other HURST products:**  
Automatic vial TrayLoaders,  
plastic vial trays and custom made  
stainless steel products.



**HURST CORPORATION 610-687-2404**  
**Box 737 - Devon, Pennsylvania 19333 - USA**

	Sample	Res. Sol. wt%	Water wt%
a	Pool 17/41/RO-1	6.0	0.1
	Pool 17/41/RO-2	6.0	0.1
	Pool 17/41/RO-3	5.9	0.1
	Pool 17/41/RO-4	5.8	0.1
	Pool 17/41/RO-5	6.1	0.2
b	Pool 17/41/RO-6	5.9	0.1
	Pool 17/41/RO-7	6.0	0.3
	Pool 17/41/RO-8	5.9	0.3
	Pool 17/41/RO-9	6.0	0.3
	Pool 17/41/RO-10	5.9	0.3
	mean	6.0	0.2
	stand dev	0.08	0.10

Table B. Result obtained from the sampling described in Figure 7.

samples in Table C by the d(0.1), d(0.5), and d(0.9) which are respectively the maximum size of the first 10%, 50%, and 90% of the distribution. These results indicate that when undertaken within acceptable limits, freezing conditions do not significantly impact on product quality.

## Discussion

There are numerous published articles discussing heat and mass transfer.<sup>6,7,9,10,11,12</sup> Here we will use the basic concept of heat and mass transfer to explain our observations regarding a process modification from freeze-drying in a glass bottle with a high fill depth, to a plastic tray with a low fill depth.

Mass transfer reflects the quantity of water vapor sublimated in unit time by a specified surface. Different flow regimens (viscous, transition, and molecular) are defined, which are governed by different equations representing different physical situations. The selection of the correct flow regimen is linked to two parameters: the mean free path [average distance of a specific molecule (water or nitrogen) between collisions] and the dimension characteristics of the system. The lower the pressure, the higher the mean free path ( $\lambda$ ) and within the lyophilization pressure range,  $\lambda$  ranges between centimeters to meters. Collisions can occur between two molecules (if there are many molecules or a high chamber pressure) or between a molecule and the chamber wall (if the distance between two walls is small or if there are only few molecules).

Mass transfer can be rate limiting in certain situations,<sup>8</sup> and in our new process, a semi-permeable membrane with a small pore size was added between the interface and the condenser. In addition, filling depth was reduced by a factor 7 in the two different types of container. Filling depth has a major impact on sublimation time ( $T_s$ ; Figure 12), as seen in the following equation, where the filling depth ( $d$ ) is taken into account three times:<sup>1</sup>

	d (0.1) ( $\mu\text{m}$ )	d (0.5) ( $\mu\text{m}$ )	d (0.9) ( $\mu\text{m}$ )
slow freezing	32.125	102.207	206.507
rapid freezing	28.548	95.527	195.108

Table C. Measurement by SLS of particle size distribution in bulk powders obtained after lyophilization with fast freezing (a) and slow freezing (b).

$$T_s = (\rho \cdot w_1 \cdot \Delta H_s \cdot w'_1 \cdot d) / [(1/K_v) + (\kappa \cdot d/2) + (\Delta H_s \cdot \omega \cdot d/2)]$$

Where:  $d$  = fill depth [m]

$\rho$  = density of the frozen solution [kg/m<sup>3</sup>]

$w_1$  = total water content [kg/kg]

$\Delta H_s$  = is the latent heat of sublimation [J/kg]

$w'_1$  = mass fraction of ice, often taken to 0.9

$\kappa$  = thermal conductivity of the frozen solution [kJ/°C.m.h]

$K_v$  = heat transfer coefficient from the shelf fluid to the sublimation interface

$\omega$  = water mass transfer [kg/h.m.Pa]

Many different resistances to mass transfer may be encountered during a freeze-drying cycle, including the sublimation interface, dried layer, and headspace both in the container and toward the condenser. At the sublimation interface, water molecules with sufficient energy are projected upward to compensate for the lower quantity of vapor molecules in the gas phase. The total pressure (water and gas) defines the likely quantity of water molecules that will escape. The sublimation interface starts at the top of the vial, and moves downward as the process progresses. The dried layer, in correlation, increases above the interface as drying progresses and after a few hours a network of channels (the size of which is pre-determined by freezing conditions, the product, and other factors) will lie above the interface. It will be more or less difficult for water molecules to flow out of this layer depending upon the openness of the network of channels. Once water molecules have escaped the dried layer, their progress will be restricted by the stopper or semi-permeable membrane, which creates a restricted pore size, and resultant 'traffic jam' of molecules before the opening. This accumulation of molecules can result in a local increase in partial pressure.

Freeze-dryer geometry affects water flow to the condenser, where a two-chamber system creates an additional restriction to passage - Figure 13.

Indeed, the surface area of the condenser and its temperature influence the condensation capacity of the freeze-dryer. Molecule transition to the condenser is achieved through a pressure gradient produced by the difference in water-vapor partial pressure of the water vapor molecules and low-temperature ice on the condenser surface. This gradient is maintained by the heat removal capacity of the ice condenser. The refrigeration system determines the maximum allowable condensation rate for the water molecules.

Although mass transfer limitations may occur when the freeze-drying cycle is too short for the mass capacity of the product, container, or freeze-dryer nominal condensing capacity, most of freeze-drying processes are more limited by heat transfer than mass transfer.

Three types of heat transfer operate during freeze-drying: conduction, convection, and radiation. Conduction occurs when two molecules have direct contact. Although at a microscopic level, there are only a few contact points between the bottom of a container and the shelves, during freeze-drying, conduction predominantly occurs inside the glass or plastic surface and the frozen layer. Convection is the transfer of energy between

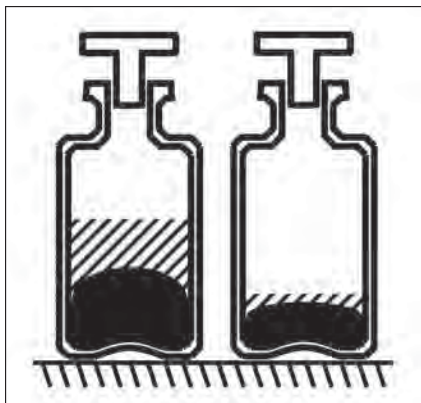

Figure 12. Impact of filling height on sublimation time. Upper part (dashed) is the freeze-dried material and bottom part (black) is the frozen part.

two surfaces through an intermediary fluid (for example air conditioning). Although at the pressures used during freeze-drying, the numbers of molecules present is reduced by a factor of at least 10,000, and the term 'convection' may become inappropriate, the transfer of heat is largely achieved by the remaining water or nitrogen molecules between the shelf and the product. Radiation is the transfer of energy by atoms or molecules, following thermal excitation. The radiant energy can be calculated using the Stefan-Boltzmann law. During freeze-drying, the main sources of radiation are shelves, walls, and the freeze-dryer door. Heat transfer through conductivity only occurs at the bottom of the vial or tray, but convection and radiation occur throughout the container with an intensity related to the composition and geometry of the container.

Heat and mass transfer link at the interface, where energy is transferred to surface molecules. Those molecules with sufficient kinetic energy escape from the interface, resulting in the reduction of the average temperature of

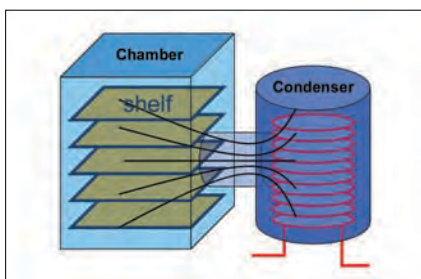

Figure 13. Water vapor mass transfer within a freeze-dryer showing a restriction between chamber (product) and condenser.

the remaining solution (the endothermic effect resulting from sublimation).

By taking the different types of heat and mass transfer into account and assigning specific values in mathematical models, the behavior of a freeze-dried product in terms of heat and mass transfer can be predicted.<sup>8,9</sup> Therefore, we have used these models to review the main differences between our two processes (bottle and ePTFE tray).

In order to achieve the defined product

characteristics, quick freezing is better than slow freezing. Inside a 1 liter glass bottle, sub-cooling may occur at first, but after crystallization, the exotherm is hardly evacuated because of the poor thermal conductivity of ice. As a result, there is not enough stored energy to obtain a quick cooling effect. In addition, the cooling energy from the shelves has a long distance to reach the surface of the liquid in the bottle, which results in a system with a mixture of small and

*Continued on page 46.*

## Reliable solutions for sterile applications



## GEMÜ - your first choice for stainless steel diaphragm valves

- **Hermetic sealing - EHEDG certified**  
 The original GEMÜ diaphragm seal system, minimum deadleg, reliable sealing even with abrasive particles
- **Exceptional service life and high reproducibility**  
 Filling, mixing, separating – and easily sterilised (SIP) and cleaned (CIP)
- **Eminently suitable for automation and control systems**  
 Positioners, position indicators, combi switchboxes, field bus solutions and more
- **Wide selection of valve bodies and configurations**  
 The largest selection of valve bodies, T-valves, tank valves, valve clusters, multiport blocks and customized solutions

**GEMÜ®**

GEMÜ Gebr. Müller Apparatebau GmbH & Co. KG · Fritz-Müller-Str. 6-8 · D-74653 Ingelfingen  
 Phone 07940/123-0 · Telefax 07940/123-224 · info@gemue.de · www.gemue.de

	Cost per Content [%]	Liter per Content [L]	Used Shelf [n]	Content per Shelf [n]	Maximum per Load [n]	Liter per Load [L]	Cycle Time [hours]	Capacity per Week [L/week]
Bottle	40	0.4	2	12	24	9.6	160	9.6
Lyoguard	100	1.7	5	4	20	34	72	68

Table D. Business case comparing freeze-drying capacity between current bottle production and lyo trays process. Cost is a percentage, Membrane tray taken as 100%.

large ice crystals, which is more difficult to freeze-dry. In the membrane tray, a large surface is in contact with the cooled shelves, and energy continues to be applied at a good rate even after system crystallization. The heat transfer rate ( $Q_s$ ) from shelf through the bottom wall of the tray during freezing conduction can be calculated using Fourier's law:

$$Q_s = A \cdot \lambda \cdot (T_p - T_s) / \delta$$

Where: A = surface of the tray [m<sup>2</sup>]

$\lambda$  = thermal conductivity of the tray [W/m.K]

$\delta$  = thickness of the bottom of the tray [m]

$T_s$  = the temperature of the shelf surface [°C]

$T_p$  = the temperature of the internal bottom surface of the tray [°C]

The heat transfer rate is increased when the surface and thermal conductivity are maximized and thickness is minimized. Although one study demonstrated that in a 1 liter glass bottle, a high fill depth was not associated with a decrease in mass transfer throughout the dried layer during primary drying,<sup>7</sup> these results were specific to one product under particular freezing conditions. Usually, the slow heat transfer through the glass and the frozen layer results in a seven day cycle, despite raising the temperature of shelves aggressively, because the contact surface between the flat bottom of the glass bottle and the shelf is minimal. Heat transfer efficacy (radiation and convection by gas through lateral walls) is also decreased by the large distance to the middle of the bottle [5 cm for a cylinder of 400 ml in a 1 liter bottle]. During secondary drying, more energy is required by the product in order to desorb the bound water and a similar heat transfer limitation will result in a longer time for this phase. Therefore, in order to obtain the same residual moisture as with tray containers, the bottle process requires more energy.

Another issue was lack of homogeneity associated with large bottle freeze-drying. It was observed that using the 1 liter glass

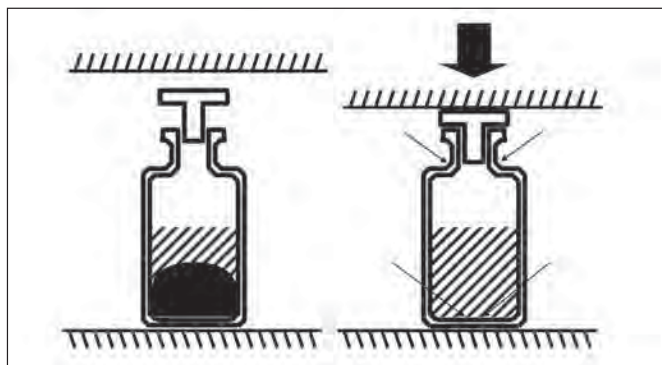

Figure 14. Representation of stoppering force on bottle side.

bottle with 400ml fill volume for a placebo trial, the final moisture content was not homogeneous within the cake, but the PVP placebo moisture content ranged from 1.6% (top) to 2.2% (bottom). With the tray, the cake was homogeneous, predominantly due to the lower filling height and subsequent lower resistance to mass flow transfer during secondary drying.

However, for tray containers, mass transfer limitation can result from the semi-permeable membrane, which has small pores of hydrophobic materials, which in turn may create a slight resistance to mass transfer. Limitations of membrane permeability were observed using our two-day cycle when the trays inflated. However, this was resolved when we adopted a three-day cycle.

Heat transfer through the plastic bottom-film of the tray also contributes to an important difference. Although plastics are known to be less conductive than glass, the plastic membrane thickness is far lower than glass. Our results showed that heat transfer was not a limitation in this case. Other differences included the lower distance to the center of the tray container compared with the bottles and the large contact area between the shelf and a low fill depth, resulting in optimal efficiency of the shelf surface. All of these differences contributed to a cycle time reduction of more than 60% compared with the former cycle and an increase of quantity loaded by batch inside the freeze-dryer - *Table D*.

Another difference between large glass bottles and membrane trays is stoppering, which creates additional stresses within glass vials. Indeed, the tensions accumulated inside the glass may be released when force is applied to the bottom surface, resulting in glass breakage, which can have a huge impact on product yields - *Figure 14*.

## Conclusions

Freeze-drying process transfer from glass bottles to single-use ePTFE membrane trays is feasible and profitable in terms of freeze-drying capacity for this specific project. However, careful process evaluation needs to be undertaken to demonstrate container compatibility and estimate the heat and mass transfer properties for the two containers. Robust process validation is a key element to success and a good understanding of the freeze-drying process is advantageous in speeding up the transfer process and releasing a quality product.

## References

1. MacKenzie, A.P., "The Physico-Chemical Basis for the Freeze-Drying Process," *Developments in Biological Standardization*, October 1976, 36:51-67.
2. Pikal, M.J., Roy, M.L., Shah, S., "Mass and Heat Transfer in Vial Freeze-Drying of Pharmaceuticals: Role of the

- Vial," *Journal of Pharmaceutical Sciences*, 73 (9): 1224-37, 1984.
3. Mayeresse, Y., Veillon, R., "On the Way to Rational Freeze-Drying," *American Pharmaceutical Review*, 2006.
  4. Mayeresse, Y., "Freeze-Drying Process Validation," *Drug Manufacturing and Supply*, 2006.
  5. Chapman, K., "The PAR Approach to Process Validation," *Pharmaceutical Technology*, Vol. 8, No. 12, pp. 22-36, 1984.
  6. Mellor, J.D., Vapour Transfer in Course of Freeze-Drying, **Advances in Freeze-Drying**, Herman Paris, 1966, pp. 75-88.
  7. Brülls, M., Rasmuson, A., "Heat Transfer in Vial Lyophilisation," *International Journal of Pharmaceutics*, 2002; 246:1-16.
  8. Nail, S.L., "The Effect of Chamber Pressure on Heat Transfer in the Freeze-Drying of Parenteral Solutions," *Journal of Parenteral Drug Association*, 1980; 34, (5): 358-68.
  9. Liu, J., Viverette, T., Virgin, M., Anderson, M., Paresh, D., "A Study of the Impact of the Freezing on the Lyophilisation of a Concentrated Formulation with a High Fill Depth," *Pharmaceutical Development and Technology*, 2005; 10:261-272.
  10. Pikal, M.J., Cardon, S., Bhugra, C., Jameel, F., Rambhatla, S., Mascarenhas, W.J., Akay, H.U., "The Nonsteady State Modeling of Freeze Drying: In-Process Product Temperature and Moisture Content Mapping and Pharmaceutical Product Quality Applications," *Pharmaceutical Development and Technology*, 2005; 10(1):17-32.
  11. Sheehan, P., Liapis, A., "Modeling of the Primary and Secondary Drying Stages of the Freeze Drying of Pharmaceutical Products in Vials: Numerical Results Obtained from the Solution of a Dynamic and Spatially Multi-Dimensional Lyophilization Model for Different Operational Policies," *Biotechnology and Bioengineering*, 1998, Dec 20; 60(6):712-28.
  12. Gassler, M., and Rey, L., Development of a New Concept for Bulk Freeze-Drying: LYOGUARD® Freeze-Dry Packaging, **Freeze-Drying/Lyophilization of Pharmaceutical and Biological Products**, Second Edition, 2004, 325-48.

## Acknowledgements

The authors would like to thank Kent Myers, Jedd Taylor (GSK Biologicals), and their team for setting up the process and undertaking the feasibility studies.

## About the Authors



**Yves Mayeresse** is Senior Freeze-Drying Manager for GlaxoSmithKline Biologicals. He has more than 15 years of experience in the pharmaceutical sector and has worked for different companies. He has managed activities, such as parenterals production, set-up of new freeze-drying facilities, design of freeze-drying cycle and development of new

stabilizers for freeze-dried products. In his current role, he is focusing on industrialization for new vaccines, performing process development and transfer of the products toward the

industrial sites of the group. He is a biochemistry engineer and a member of the Parenteral Drug Association (PDA), the Pharmaceutical and Healthcare Sciences Society (PHSS), and the Association for Clean and Sterile Products (A3P) as well as a regular speaker for conferences on freeze-drying. He can be contacted by telephone: +32-2656-8131 or by email: yves.mayeresse@gskbio.com.



**Vinciane De Cupere** has been with GlaxoSmithKline Biologicals for three years as a scientist. She holds a PhD in agronomic science and bioengineering. During her academic course, she developed research activities in the field of biomaterials and semi-conducting liquid crystalline materials. She is currently working on industrialization for new vaccines, performing process development, and transfer of the products toward the industrial sites of the group. She can be contacted by telephone: +32-2656-5635 or by email: vinciane.de-cupere@gskbio.com.



**Romain Veillon** is a freeze-drying scientist at GlaxoSmithKline Biologicals. He has been involved in parenteral freeze-drying for more than 10 years. He has been involved in new freeze-drying units projects, freeze-drying cycle validation, and support to production in Sanofi Pasteur and Eli Lilly. He is currently focused on new vaccine industrialization, performing process development, evaluation, and validation. He also is involved in PAT development applied to freeze-drying, such as DOE, chemometry, NIR, and vision. He is an industrial pharmacist, specializing in microbiology. He can be contacted by telephone: +32-2656-9752 or by email: veillon@gskbio.com.

GlaxoSmithKline, Rue de L'institut 89, Rixensart, 1330, Belgium.



**Joseph F. Brendle** is the Product Manager for Gore™ Lyoguard® Freeze-Drying Products at W.L. Gore & Associates, Inc., where he is responsible for products and applications using Gore™ membranes in pharmaceutical lyophilization applications. Prior to joining Gore in 2005, Brendle spent 18 years developing and managing freeze-drying technologies for both laboratory and production applications in the pharmaceutical industry at FTS Systems, Inc. and at Steris Corporation. While with FTS Systems, he led collaboration with University of Connecticut and Purdue University to develop SMART Freeze-Dryer™ Technology. He has lectured at numerous companies and industry conferences on freeze-drying technology and holds a BSME from Clarkson University. He can be contacted by telephone: +1-410-506-8956 or by email: jrbrendle@wlgore.com

W.L. Gore & Associates, Inc., 401 Airport Rd., Elkton, Maryland 21921, USA. 

This article presents a description of an operational effectiveness project to improve clinical material manufacturing efficiency of a biologics pilot plant. It utilizes lean and Kaizen principles to identify root causes, then brainstorm/ evaluate potential solutions.

## Clinical Manufacturing Efficiency

by Beth H. Junker, Kay Hunsberger, Vicky Griffin, Kent Hamaker, Carl Holz, Amy Caparoni, Kelly Kistler, Jeffrey Graczyk, and Marshall Gayton

### Introduction

**D**riving operational excellence improvements into non-manufacturing areas, such as process development and manufacturing clinical supplies, can be a cultural shift for managers as well as bench staff.<sup>3</sup> There is a natural tension between efficiency, control, and process excellence (all of which demand precision, consistency, and repetition) and innovation (which demands variation, failure, and serendipity).<sup>2</sup> However, operational excellence improvements can boost the available time and capacity for execution of new processes through the streamlining of lower priority activities.

Traditional lean practices also are challenging to apply to highly variable and shared asset environments typical of multi-product biopharmaceutical processing facilities,<sup>3</sup> especially those largely devoted to early phase clinical manufacturing. The less routine, repetitive, and predictable the activity, the more difficult to apply lean and six sigma tools.<sup>4</sup> In addition, it is notably harder to apply lean controls to less efficient processes and facilities,<sup>5</sup> which often are associated with early phase clinical manufacturing. Improvement opportunities in such

environments frequently are cross-functional requiring substantial collaboration across the organization.<sup>6</sup>

Operational excellence obstacles to improving clinical manufacturing efficiency overlap with those commonly identified for efficiency initiatives in other industries. These are: 1. identifying adequate metrics to quantify performance, 2. overcoming required cultural changes in the organization, and 3. applying these concepts to non-production aspects of clinical manufacturing environments, such as business processes that largely rely on human actions.<sup>7</sup> Furthermore, organizational silos and less integrated operations often prevent decision-making based on impact on overall workflow and/or key performance indicators.<sup>3,8</sup> Uneven sponsorship by managers and “on the floor” supervisors also hinders achieving and sustaining the necessary leadership and culture for change.<sup>8</sup>

In addition, service families (product groups possessing similar processing steps) in lean applications can be viewed as product platforms in biopharmaceutical processing, specifically groups of products that undergo similar processing steps, such as some vaccines (e.g., plasmid DNA) and therapeutic proteins (e.g., antibodies). Separate platforms cover cell line, upstream, downstream, and formulation aspects of bioprocessing. Despite the need to allocate significant upfront costs and resources to their development, process platforms improve process efficiency, reduce subsequent development and production costs, improve speed to market, and free up substantial resources for other projects.<sup>9,10,11</sup> Platforms standardize a broad range of manufacturing steps and materials (e.g., production equipment, media, buffers, bioreactor

Figure 1. Generalized process flow diagram for clinical manufacturing of a platform CHO antibody bulk. [Raw Material (RM), Culture Media (CM), Atypical Process Reports (APRs)].

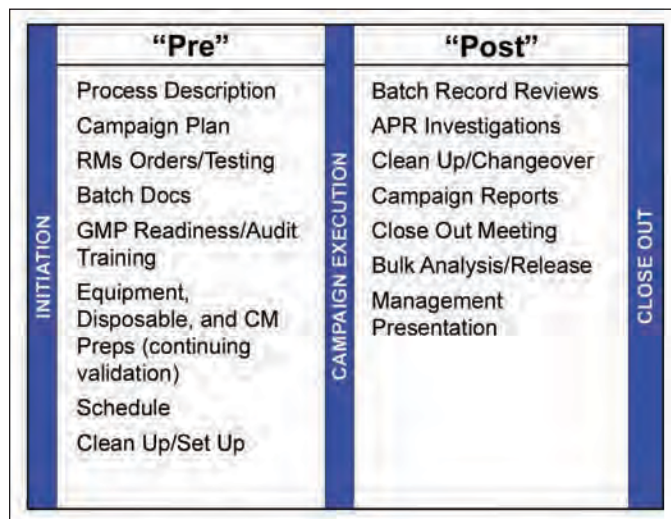



# Innovation makes it possible

Telstar Life Science solutions is constantly innovating to offer tailor-made solutions in high technology equipment for the pharmaceutical, biotech and related industries.

With over 45 years of experience and an international presence in more than 100 countries, Telstar is your partner to provide solutions in the following technologies:



High Containment Isolators



Sterilization Systems, WFI & Pharmaceutical Steam Generation Systems



Freeze Drying Systems



### Containment Systems

- Isolators
- Restricted Access Barrier Systems (RABS)
- Downflow booths

### Sterilization Systems

- Moist heat sterilization autoclaves
- Chemical agent sterilization autoclaves
- Sterilization and depyrogenation ovens

### WFI & Pharmaceutical Steam Generation Systems

- Multiple/simple effects stills
- Pure steam generators

### Freeze Drying Systems

- GMP production freeze dryers
- Laboratory freeze dryers
- Loading & unloading systems

### Laminar Air Flow Systems

- Laminar flow benches
- Biosafety cabinets
- Laminar flow booths
- Customized cabinets

### Drying Systems

- Hot air drying
- Vacuum drying

### TELSTAR LIFE SCIENCES

Josep Tapioles 120  
08226 Terrassa (Spain)  
T. +34 937 361 600  
F. +34 937 859 342  
sales.pharma@telstar.eu

### TELSTAR NORTH AMERICA

1504 Grundy's Lane,  
Bristol, PA 19007 (USA)  
T. +1 215 826 0770  
F. +1 215 826 0222  
telstar.na@telstar.eu

conditions, filters, chromatography resins, batch records, automation systems, quality procedures)<sup>10</sup> permitting facility, equipment, and business process standardization. When the product is amenable, product-specific customization is greatly minimized for platforms, especially for early phase products, compared with non-platform technologies.

## Opportunity and Scope

Clinical manufacturing in a multi-product pilot-scale GMP bioprocessing facility is primarily limited by personnel, and in a few cases, shared equipment, potentially resulting in clinical delays for various product candidates (i.e., therapeutic proteins, vaccines). A typical clinical manufacturing campaign involves several dozen personnel, a series of individual high technology bioprocessing facility suites, as well as significant expenses for raw materials, consumables, and maintenance.

The goal of this project was to identify and reduce waste in campaign “pre” and “post” activities. “Pre” and “post” activities such as campaign planning, batch sheet document generation, training, raw material/culture media release, set up/clean up, and closeout activities were in scope - *Figure 1*. “During” activities associated with campaign execution, as well as analysis and release of manufacturing bulk, were out of scope. Alteration of GMP, safety, or environmental regulations also was considered out of scope.

Specifically, the project goal was to reduce campaign-associated professional staff time by 10% and cycle time by 25%. This effort focused on improving clinical manufacturing efficiency via streamlining of “pre” and “post” activities (i.e., availability) to raise batch throughput with the same personnel level. Future efforts may focus on “during” activities (i.e., performance) and rework/reprocessing (i.e., quality).

## Project Approach

The project approach was first to focus analysis on the most frequent type of product campaign conducted in the facility, Chinese Hamster Ovary (CHO)-derived monoclonal antibody bulks produced using a documented processing platform. These campaigns were used to develop, qualify, and quantify (where possible) the current state. Because these campaigns were the most common, as well as more recently executed, it was more straightforward for team members and other subject matter experts to reach consensus based on their individual past experiences. As each of the remaining project deliverables were developed, their applicability to other campaign types (i.e., other therapeutic proteins or vaccines) was checked. In nearly all cases, the deliverables were found applicable to some extent.

The project utilized a hybrid lean/Kaizen approach over a time period of about four months. Using voice of the customer information, current state estimates and data, and current state value stream mapping (visualization of all activities creating customer value), four Critical-To-Quality (CTQ) key measurable characteristics that satisfy the customer when achieved, areas were established. These CTQs were: 1. documentation, 2. clean up/set up, 3. raw material/culture

media (RM/CMs) release, and 4. training. This effort was followed by creation of a current state swim lane map (showing which group executes what steps when multiple groups are working together). For each CTQ, a root cause analysis was conducted, followed by solution brainstorming, ranking, analysis, and prioritization. Next, a future state swim lane map (showing how the process will operate once improvements are implemented) was developed, linked to enabling improvement solutions, and benefits quantified. Finally, new performance targets and an improvement process control plan were established.

## Critical to Quality Areas

### *Voice of the Customer*

Voice of the Customer (VOC) information was collected using interviews and surveys of personnel at first line and upper management, as well as bench staff levels. Main customers resided in the clinical manufacturing, quality, and process development areas. Clinical manufacturing management was particularly interested in clarifying roles and responsibilities, raising information transfer reliability, improving staff’s understanding of their colleague’s roles, and broadening change opportunity identification and execution. Clinical manufacturing staff members were particularly interested in task standardization along with reducing multi-tasking and multi-campaign responsibilities. Quality was particularly interested in instituting focused campaign closeout timelines. Process development was particularly interested in expanding opportunities for processing flexibility where possible.

Key customer themes were efficient business processes, including reduction of multi-tasking stresses and raising staff’s ownership, accountability, and focus. When customer concerns were organized into related categories, three areas of commonality were revealed: 1. project management (specifically competing task priorities, schedule churn, and sub-optimal communication with stakeholders, partners, and customers), 2. systems (specifically selection, procurement, storage, testing, and release of Raw Materials (RM) and Culture Media (CM); ordering, availability, assembly, sterilization, and delivery of disposable and non-disposable parts; equipment preparation particularly to address pre-campaign audit findings; training attendance and effectiveness; and knowledge management expectations and procedures), and 3. roles and responsibilities (specifically ownership, hand-offs, and timeline adherence).

## Value Stream Mapping

Value stream mapping was undertaken using a highly simplified process flow diagram from campaign initiation through closeout, omitting depiction of overlapping and parallel activities - *Figure 1*. Four activity classifications emerged as high pain and inefficient areas: 1. documentation (i.e., draft and final pre-execution documents as well as post-execution closeout), 2. raw materials and culture media (i.e., ordering, testing, and release), 3. clean up/set up (i.e., assembly, cleaning, verification, and sanitization/sterilization), and 4. training (i.e., scheduling and content). These activity classifications were the identified CTQs for the overall goal of efficient processes

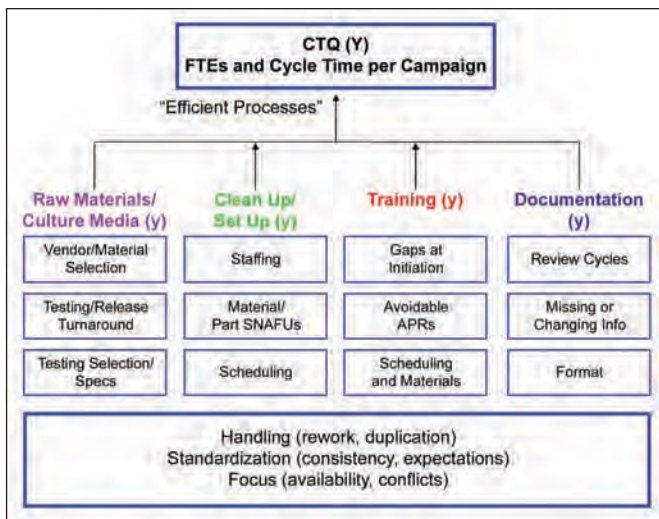

Figure 2. Critical-to-Quality attributes for clinical manufacturing of a platform CHO antibody bulk.

for clinical campaigns - *Figure 2*. Key input factors for each CTQ, later revealed during root cause analysis, were listed below each individual CTQ. Common root causes across CTQs were listed at the bottom.

The longest cycle time activities within the project scope were RM/CM release and documentation - *Figure 3*. As a first step, typical cycle time, touch time, touch time/cycle time ratios, first pass yields, and personnel resources were estimated based on platform CHO antibody campaign experiences - *Figure 3 inset*. Where available, data was used for validation of these estimates. Specifically, “pre” and “post” campaign activities accounted for 62% of the total campaign personnel resources (38% “pre” and 24% “post”); equipment set-up/clean-up activities accounted for 60% of the total downstream isolation cycle time.

## Initial State Swim Lane Map

A swim lane map showing serial and parallel (or overlapping) activities was developed based on the current state of platform CHO antibody campaigns. *Figure 4* shows the “pre” phase

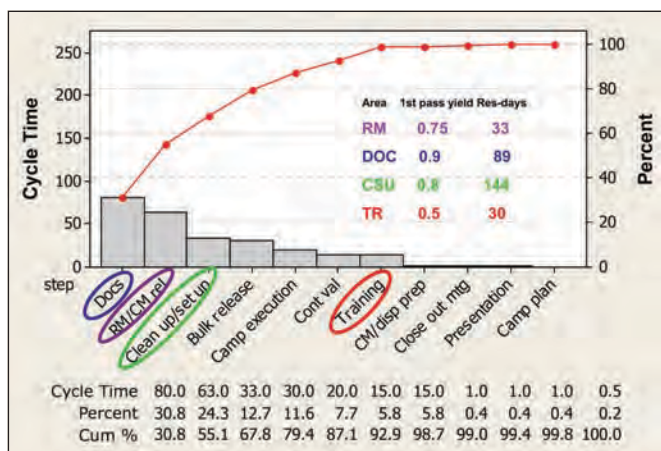

Figure 3. Pareto chart of key process steps for clinical manufacturing of a platform CHO antibody bulk. Inset: First time yield and resources for key critical to quality attributes. [Docs = documentation, RM/CM rel = raw material/culture media ordering, testing and release].

and *Figure 5* shows the “post” phase. The team attempted to convert as many of the serial activities to parallel activities as possible, then determined how to streamline the key serial activities, i.e., the four CTQs from the value stream map: 1. documentation (docs), 2. raw materials and culture medium (RM/CM), 3. clean up/set up, and 4. training. The goal was to identify and remove waste in the form of wasted movement, wasted time, physical/material waste, wasted protocols/procedures, and reduced rework/failures.<sup>12</sup>

Based on entitlement estimates (expected efficiencies based on attaining reasonable improvement levels) and supported where possible by data, six weeks were eliminated, three from “pre” and three from “post” activities - *Figures 4 and 5*. An additional one week likely could be eliminated from both “pre” and “post” activities, but that elimination was considered too aggressive at this time. Key cycle time changes were aligned with the four CTQs - *Tables A and B*: 1. require process description (authored by process development staff) at campaign planning initiation - *Figure 4*, 2. condense pre-campaign training to three weeks - *Figure 4*, 3. reduce equipment and suite GMP readiness and pre-execution documentation draft and review cycles to one week each - *Figure 4*, 4. reduce in-suite set up/clean up (specifically suite changeover) by one week - *Figure 5*, 5. reduce RM/CM testing/release time to five weeks - *Figure 5*, 6. reduce post-execution documentation review time (both batch records and atypicals) to four weeks - *Figure 5*.

## Root Cause Identification

Root cause identification was undertaken to determine how to improve efficiency for the four CTQs that emerged.

First, general root causes were established based on identified trends observed in the VOC collection phase. Lower first pass yields (fraction of work completed correctly on the initial try) of around 0.7 to 0.8 for some activities associated with

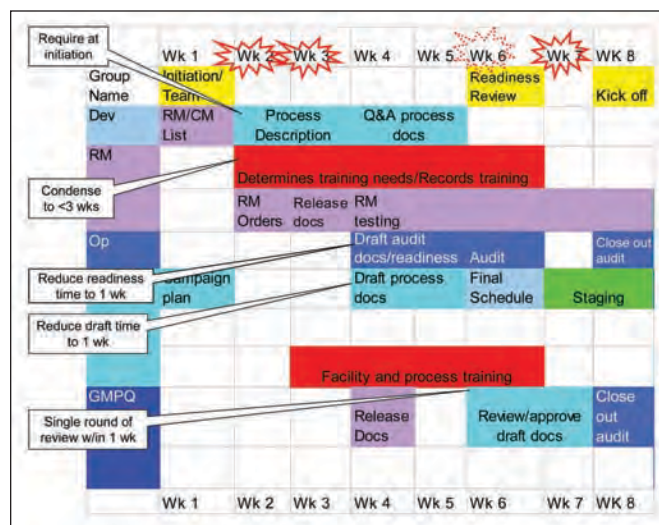

Figure 4. Current state swim lane map for initiation to kick off (“pre”) of clinical manufacturing of a platform CHO antibody bulk. Potential reduction of three weeks (possibly four). [Dev = process development, RM = raw material planners, Op = clinical manufacturing operations, Proc = clinical manufacturing processing, GMPQ = quality].

Continued on page 52.

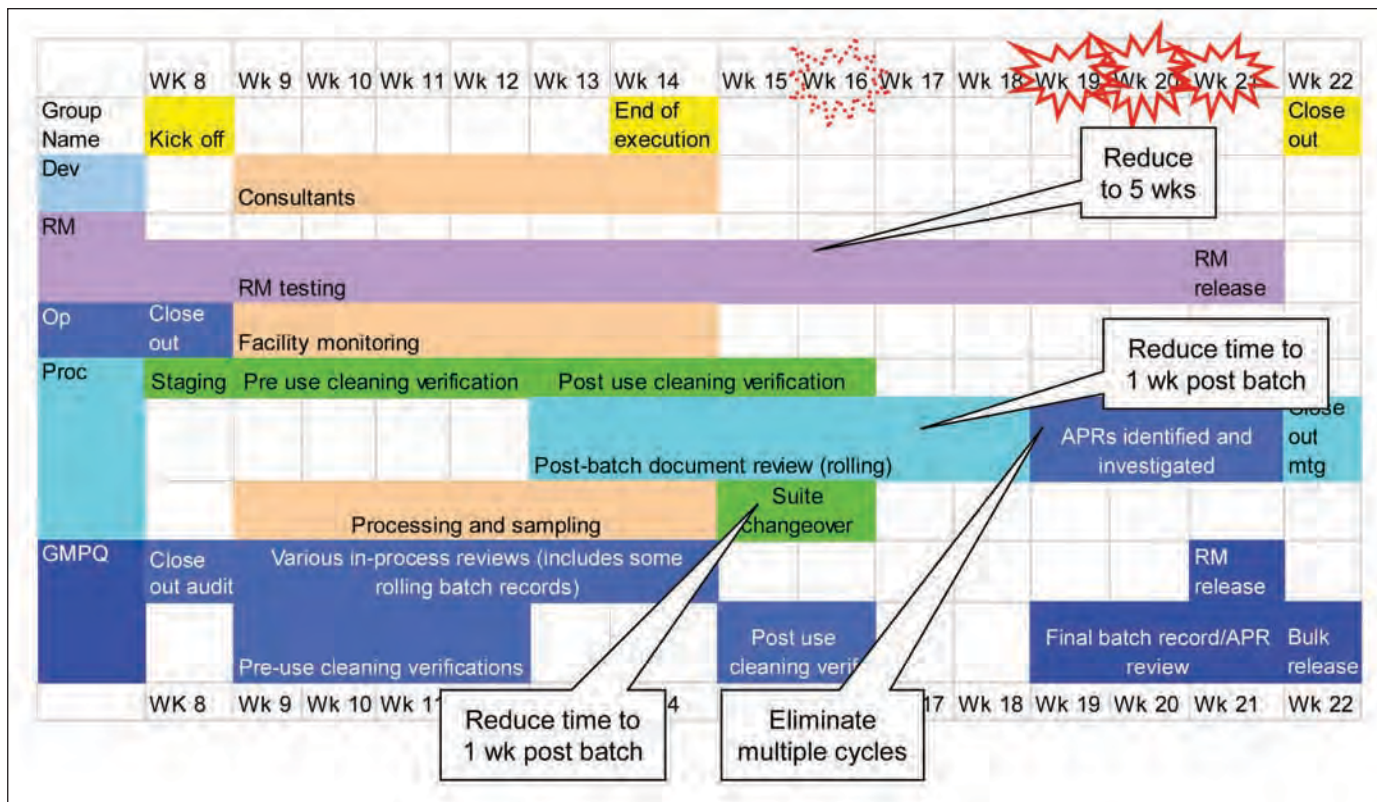

Figure 5. Current state swim lane map for kick off to close out (“execution” and “post”) of clinical manufacturing of a platform CHO antibody bulk. Potential reduction of three weeks (possibly four). [Dev = process development, RM = raw material planners, Op = clinical manufacturing operations, Proc = clinical manufacturing processing, GMPQ = quality].

platform campaigns. This low value suggested remaining execution variability despite undertaking a platform process, likely owing to incomplete platform adherence. Ripple effects of small changes or missing information among multiple areas suggested significant data duplication, specifically in documentation. Multiple rounds of rework suggested that 1. the activity timing or level of detail was not aligned with process lock down (or vice-versa) and 2. expectations for con-

tent, format, and timing between stakeholders and customers (e.g., reviewers and approvers) were not clear. These general root causes - Figure 2 translated into issues of handling (i.e., expending additional effort beyond what is required), standardization (i.e., limited effectiveness in sharing best practices among multiple people conducting similar tasks), and focus (i.e., varied task demands and competing priorities causing resource availability conflicts).

CTQ	Root Cause	Cycle time changes	Project Solution
RM/CMs	Vendor selection Material selection Allocation Test selection Specification setting	RM/CM list at planning initiation	Preferred vendor list for proc dev and orders Approved RM list for proc dev and orders Locked-unlocked info in RM/CM list Future IT solution Next belt project Next belt project
Docs	Process changes Standardization Info/task duplication	Process description at planning initiation Reduce draft and review cycles to one week each	Locked-unlocked info in process description Expectation checklist Table/bullet format Streamline type/number of items tracked Annual equip audits, equipment owner, safety leverage/gap analysis for audits/readiness
Clean up/ set up	Staffing level Cycle overkill Parts in suite	Reduce audit/readiness to 1 week	Reduce from 2 to 1 except where required Create buffer cycle to lower buffer prep time Establish bins for COPs for common skids Establish out-of-suite storage area/standard staging
Training	Availability/conflicts Proximity	Condense to 3 weeks Virtual/video training	Attendance expectations/shared calendar

Table A. Relation of CTQs to root causes to cycle time changes and enabling project solutions for initiation to kick off (“pre”) of clinical manufacturing of a platform CHO antibody bulk.

Specific root causes for each of the four CTQs then were brainstormed using a fishbone diagram with branches for material (e.g., raw material quality, part availability, utility reliability), methods/manufacture (e.g., abnormal operation, unclear/inconsistent procedures, suboptimal process set points or other specifications, changing guidelines/regulations), manpower (e.g., manual steps and control, technical expertise, knowledge transfer), machine (e.g., inefficient equipment, frequent equipment breakdown, insufficient capacity), measurement (e.g., instrument failure or error, miscalculation, lack of measurement), and environment (e.g., seasonal/holiday patterns, management structure, physical locations).<sup>13</sup> These specific root causes are listed in Table A for “pre” and Table B for “post” activities.

### Solution Identification

#### Solution Matrix

During multiple team sessions focusing on closing individual CTQs gaps, potential solutions were brainstormed and evaluated based on effort/impact (2x2 matrix) and customer importance criteria (Pugh matrix). About 100 solutions were designated high impact (~50 low and 50 high effort), and about 20 solutions were low impact (~10 low and ~10 high effort). All low effort/high impact and selected high effort/high impact solutions from the 2X2 matrix were then evaluated using the Pugh matrix. Customer importance criteria were roughly equally weighted by team members, then used to evaluate a solution's impact (rated as +1 if beneficial, 0 if neutral, or -1 if harmful) on resources per campaign, cycle time, first pass yield, campaign lead time, staff multi-tasking/availability, communication/hand-offs/ownership, knowledge management, and effective use of talent. The highest net benefit scores were used to select key solutions. Based on VOC information, process inputs with the largest impact on these customer importance criteria were deliverables from the process development staff, business process consistency, and level of risk tolerance; solutions that were related to these particular

process inputs thus, were considered more desirable.

High impact proposed solutions, particularly those that also were low effort, were vetted more closely for benefits, resources to implement, realization risks, risk mitigation, performance metrics, and control plans. A formal Failure Modes and Effects Analysis (FMEA), i.e., systemic determination of seriousness and sources of potential process problems) rating

was not conducted owing to the number of proposed solutions; qualitative assessments of realization risks were considered adequate to support further solution selection. Solutions with the clearest impact to the CTQs of this efficiency project (Tables A and B) were prioritized with additional ones to be added as initial ones were completed. Priority low effort/high impact solutions (i.e., implementable within one to three months) were assigned to clinical

*Continued on page 54.*

## Valve Communication for Today's Control Systems

- Innovative Sensing Technology for Reliability and Repeatability
- Remote Programming for Efficiency in Commissioning and Operations
- Status and Diagnostics Remote and Local Display



CALL US TODAY AT 404-344-8970.

**GEMÜ**® VALVES, ACTUATORS AND CONTROL SYSTEMS

3800 CAMP CREEK PARKWAY • BLDG. 2600 • SUITE 120  
ATLANTA, GA 30331 • FAX 404-344-9350 • [www.gemu.com](http://www.gemu.com)

CTQ	Root Cause	Cycle time changes	Project Solution
RM/CMs	Testing/release turnaround Insufficient tech support <i>At risk usage</i>	Reduce testing/release to 5 weeks	Establish test time expectations/data entry Designated analytical RM/CM analyst expert <i>Next belt project</i>
Docs	Suitability Availability/conflicts	Reduce closeout to 4 weeks	Expectation checklist, APR mapping workgroup Consolidated document closeout effort Designated campaign closer
Clean/ set up	Availability/conflicts	Reduce by 1 week	Consolidated clean up effort Reduce CIP staffing from 2 to 1 except when required

Table B. Relation of CTQs to root causes to cycle time changes and enabling project solutions for execution to closeout (“post”) of clinical manufacturing of a platform CHO antibody bulk.

manufacturing staff (working jointly with stakeholders) and an identified project team champion/liasons. Priority high effort/high impact solutions (i.e., requiring more than one to three months) were also identified and tracked to provide a complete solution portfolio to the clinical manufacturing leadership team.

## Future State Swim Lane Map

Future state swim lane maps were constructed for the “pre” and “post” phases of platform CHO antibody campaigns - *Figures 6 and 7*. Identified enabling solutions (Tables A and B) were used to translate future state entitlement maps into concrete action plans and measurable goals. Long cycle times remained for bulk release and campaign execution (both out of scope for this initial project). This future state eliminated six weeks to generate a new process lead time (PLT) of ~16 weeks (3.7 months).

One example of an enabling solution was to require a raw materials list and locked process description at campaign planning initiation ~six weeks before processing kick off in the future state - *Figure 6*. This trigger cut down two weeks of lead time previously devoted to process description changes and updates. To enable this change (and achieve other busi-

ness goals), process development activities were frontloaded (i.e., undertaken earlier in the product development timeline). Also, process description requirements were redesigned to lock certain inputs with substantial “pre” phase impact (e.g., equipment size, resin type) and permit flexibility up to pre-execution batch sheet approval for other inputs with negligible “pre” phase impact (e.g., buffer pH).

In addition to process description changes, other areas to standardize to raise first pass yields included creating and circulating checklists detailing batch sheet documentation expectation requirements (both “pre” and “post” approval - *Figures 6 and 7* respectively), uniformly calculating preparation/processing times and listing execution issues in campaign reports (e.g., campaign step summaries - *Figure 7*), and streamlining the type/number of equipment items tracked for campaign readiness checks - *Figure 6*. Documentation (e.g., batch sheets, audits, process descriptions) was best cast in a reusable table or bullet format so that translation or reference to other documents (e.g., Atypical Processing Reports (APRs), step summaries) was facilitated - *Figure 6*. Information duplication was reduced by leveraging work already completed (e.g., referencing not attaching original documentation), and for similar processes, performing a gap analysis focused only on changes from a designated base process - *Figure 6*.

Other key enabling solutions applying to the “pre” campaign phase (*Figure 6*) were to 1. decrease buffer preparation lead time by establishing a reduced cleaning cycle appropriate for buffers (substantially shorter than the worst case fermentation media cleaning cycle), 2. minimize training at the time of the specific campaign, 3. develop a shared electronic training calendar to avoid training session schedule conflicts, 4. prepare virtual/video training available on demand for key training sessions, 5. establish bins for clean-out-of-place (COP) parts associated with commonly used skids (parts remained together from use to cleaning to assembly and back again), 6. right-size CIP staffing by assigning two people only when required by GMP or safety/environmental regulations rather than routinely, and 7. minimize raw material release timelines by instituting easy-to-read approved raw material and preferred vendor lists for process development staff to reference when process changes were required.

Additional key enabling solutions applying to the “post” campaign phase (*Figure 7*) were to 1. establish a target of one week post campaign for closeout activities by maintaining associated personnel undistracted on the current campaign,

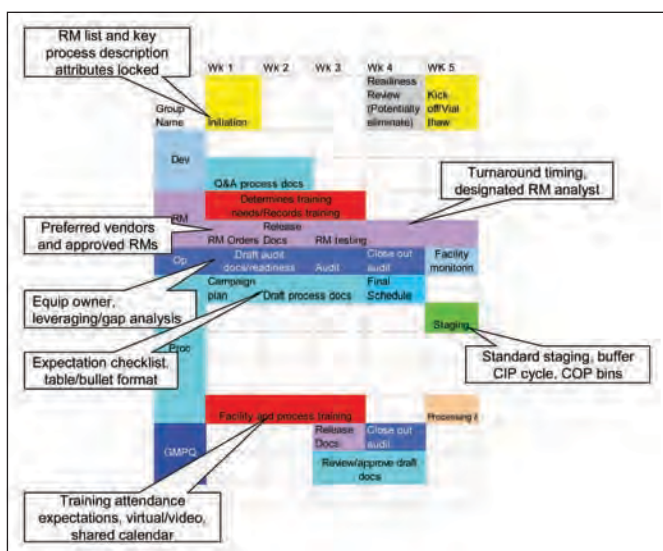

Figure 6. Future state swim lane map showing five week cycle time from initiation to kick off (“pre”) of clinical manufacturing of a platform CHO antibody bulk. [Dev = process development, RM = raw material planners, Op = clinical manufacturing operations, Proc = clinical manufacturing processing, GMPQ = quality].

2. implement daily (rolling) in-process batch sheet reviews according to an expectation checklist, 3. streamline APR resolution using joint operations/quality meetings to outline investigation strategy and subsequent write up before initiating investigations, 4. decrease turnaround time for Raw Material and Culture Media/Buffer (RM/CM) release by establishing target testing turnaround times with contract laboratories as well as setting up contract lab personnel to remotely enter results directly into the area's LIMS system, and 5. improve knowledge management via follow up on lessons learned and high quality team leader training meetings.

Key personnel roles to establish for realizing the future state were: 1. a campaign closer to coordinate post-execution document reviews and approvals (also eventually including in process reviews) as well as suite clean-up and changeover, 2. a designated analyst for technical support to streamline raw material and culture media release, including Out-Of-Specification (OOS) investigations (Figure 7), and 3. equipment and suite owners to facilitate equipment and suite readiness for GMP operation, for example, by performing annual equipment audits and then rigorously controlling equipment usage and modifications - Figure 6.

In envisioning the future state, each clinical manufacturing campaign team is akin to a production cell in that the goal is to arrange equipment (and/or dedicate personnel) for a smooth process flow such that progressive processing occurs

without waiting or additional handling. The documentation (both GMP and non-GMP) associated with campaign planning, execution, and wrap-up is essentially standardized work, for which a precise description can be devised specifying its cycle time (actual process output rate), takt time (desired process output rate to meet demand), work sequence, and minimum required "parts" inventory in the form of advance preparation time.<sup>14</sup> Standardized work elements (specifying the best method to execute the job correctly the first time) already exist for actual biopharmaceutical process execution in the form of SOPs, testing methods, and validation protocols; however, these documents often omit key details resulting in variations in how steps are completed to achieve the same result.<sup>15</sup> The same gap holds true for standardized work elements applicable to "pre" and "post" campaign activities. Clear documented roles and responsibilities at the appropriate level also were required.

## Future State Benefits and Performance Targets

Cumulative manpower and cycle time benefits for "pre" and "post" activities were calculated for selected low effort/high impact solutions for a platform CHO antibody campaign. The manpower benefit identified was 16.5%, exceeding the target of 10%, with one change (right sizing CIP staffing) accounting for 8.5% of the reduction. The cycle time benefit was 37.5%,

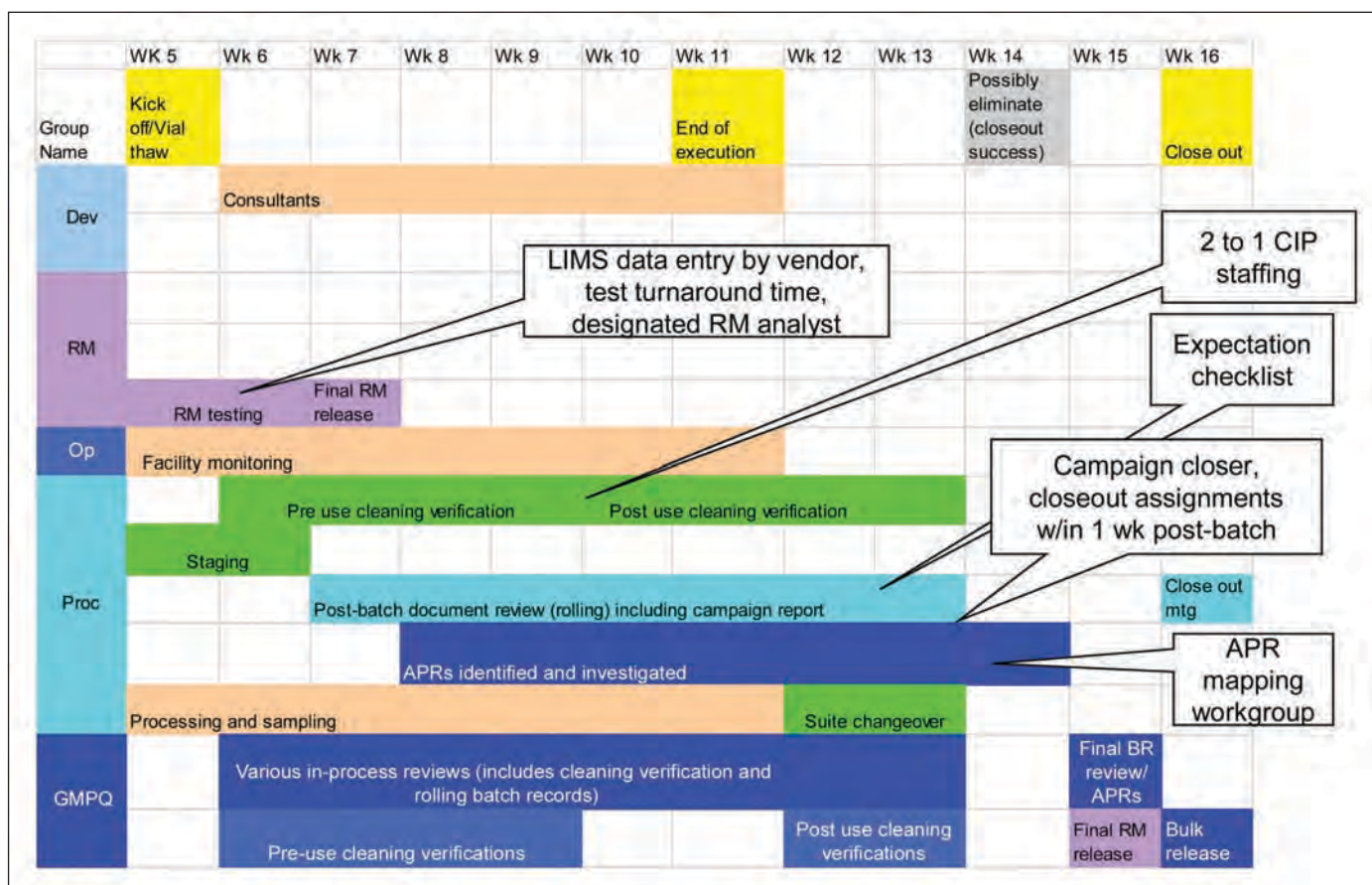

Figure 7. Future state swim lane map showing 12 week cycle time from kick off to close out ("execution" and "post") of clinical manufacturing of a platform CHO antibody bulk (total cycle time from initiation to close out of sixteen weeks). [Dev = process development, RM = raw material planners, Op = clinical manufacturing operations, Proc = clinical manufacturing processing, GMPQ = quality].

Continued on page 56.

exceeding the target of 25%.

Specific future state performance targets also were calculated based on a platform CHO antibody campaign. These targets were to 1. reduce manpower by 10%, 2. reduce the “pre” and “post” campaign manpower proportion by 30%, 3. reduce the Process Lead Time (PLT), i.e., time from initiation to close out for one campaign, to 3.7 months, 4. decrease Work-In-Progress (WIP), i.e., number of bulk campaigns being concurrently either planned, executed, or closed out, to three, and 5. reducing in suite set up/cleanup time to three weeks thus increasing suite overall availability to 57%. In addition to these targets, the number of atypicals (APRs), Out-of-Specifications (OOSs), and other deviations was desired to remain constant (or even decrease), particularly those due to human error to ensure that the implemented solutions did not raise numbers of avoidable mistakes.

## Implementation and Control

The solution portfolio was assembled and vetted. Where applicable, initiatives in progress outside of this project were included to generate a comprehensive list for the area’s senior leadership team to evaluate for prioritization against limited manpower availability for initiatives. Lower and higher effort high impact priorities were established. Since not all solutions were able to be adopted simultaneously, as some solutions were completed other solutions were to be initiated. Thus, considering available staff time, selected solutions were given the go-ahead and assignments made. An implementation tracking spreadsheet was created to track progress. The project team collected and reviewed updates weekly and then met monthly with the area’s leadership team to review progress. In a few cases, pilot implementations were conducted, particularly applying solutions first to more frequently executed campaign steps (e.g., filtration).

A reasonable yet robust control plan also was developed. Existing metrics were leveraged and new metrics established where needed. A dashboard was created and graphs loaded with prior campaign data over the last two to three years. Targets were set for platform CHO antibody campaigns (based on the more extensive prior experience in the facility), but performance of other product campaigns types also was tracked for comparability.

The initial metrics selected were: 1. personnel effort/campaign (a measure of staffing and execution efficiency), 2. campaign initiation to closeout time (a measure of focused effort to maintain campaign throughput), 3. number of bulk campaigns simultaneously in any stage from initiation to closeout (a measure of limiting work in progress to retain focus), 4. length of longest release time for a campaign’s raw material since any unreleased item delayed close out (a measure of both utilization of approved raw materials or preferred vendors and testing lab turnaround time/release efficiency), 5. percentage of buffers in a campaign able to undergo established reduced testing regimens (a measure of preferential utilization of preferred buffers), 6. percentage training matrix completion at initiation (a measure of personnel retention on multiple campaigns and ability to schedule training off

critical campaign paths), 7. non-equipment-related SNAFUs during clean up/set up (a measure of part availability and preparation suitability), 8. length of longest atypical report completion time (a measure of utility of available guidance documents and pre-investigation meetings), 9. right first time and hours required for document audit for quality approval (a measure of checklist effectiveness at outlining expectations), and 10. percentage of avoidable atypicals (a measure of training effectiveness since training gaps were usually cited when human error was identified as the root cause).

As high effort/high impact solutions became implemented, additional metrics were to be added. These included 1. the percentage of time for set up/clean up relative to process time (a measure of cleaning procedure efficiency), 2. a qualitative assessment of pre-campaign GMP, safety, and environmental checklist execution effort expended (a measure of leveraged work from prior campaigns), and 3. the percentage of approved raw materials/preferred vendors utilized per campaign (a measure of adherence to and suitability of the listing).

The project then was officially turned over to a single process owner (an experienced staff member in the clinical manufacturing area) for clear accountability, specifically for continuing the implementation and updating the dashboard monthly with new data from recently completed campaigns. Future platform CHO antibody campaigns were expected to be intermittent (<25% of all area campaigns) owing to changing product pipelines. Success of key improvements appeared measurable based on the performance of other product campaign types. However, measured improvements may be smaller owing to other sources of associated inefficiency for non-platform work.

Five potential larger impact derailleurs to overall implementation were mitigated by control measures or other means. Specifically: 1. exceptions to the process description and approved raw material/preferred vendor regimens were permitted only with associate director/director approvals; 2. diversions to support unexpected problems and tight timelines were minimized by maintaining strong sponsorship at the senior director/executive director levels; 3. introduction of major new equipment or process changes that extended “pre” campaign efforts was governed by oversight committees which regularly reviewed process development efforts; 4. remaining obstacles to prompt raw material/culture media release (such as at risk usage, test selection, and specification setting) were addressed through a subsequent efficiency effort; and finally, 5. perceptions about the limited time and resources available to work on/implement efficiency initiatives were defused by widely communicating early victories to demonstrate incremental progress toward continuous improvement.

## Summary

The clinical manufacturing efficiency project established a shorter, more efficient, and focused campaign effort from initiation through close out. Utilizing lean/Kaizen techniques, this project not only generated a prioritized and vetted solution portfolio. It also indicated the area of raw materials and culture media to be where application of statistical and other six



sigma tools was likely to be beneficial in a future belt project. When biopharmaceutical pipelines gather momentum, clinical manufacturing throughput often becomes the bottleneck. Expanding resources by adding personnel or equipment can be challenging, especially when simultaneously faced with expense and capital cost-sparing objectives. Consequently, projects aimed at continuous improvement of clinical manufacturing efficiency are valuable solid foundations to support projected biopharmaceutical product development.

### References

1. Puich, M., "Biopharmaceutical Operations Excellence—2006 and Beyond," *Biopharm International*, 19(3):30-32, 2006.
2. Hindo, B., "At 3M, A Struggle between Efficiency and Creativity," *Business Week*, 4038:8-14, 2007, [http://www.businessweek.com/print/magazine/content/07\\_24/b4038406.htm?chan=g1](http://www.businessweek.com/print/magazine/content/07_24/b4038406.htm?chan=g1)
3. Geller, S., "Reduce Waste by Getting Lean," *Pharmaceutical Technology*, 130, March 2007.
4. Wootto, M., "Mining for Value, but Where?" *Pharmaceutical Processing*, 23(9):50-57, 2007.
5. Kanarak, A., "It's About Time! Operational Excellence and the Biopharmaceutical Industry," *BioProcess Int.*, 5 (S6): 20-21, 2007.
6. Puich, M., "Biopharmaceutical Operations Roadmap 2007," *Biopharm International*, 20(4):42-47, 2007.
7. Gras, J.M., Philippe, M., "Application of the Six Sigma Concept in Clinical Laboratories: A Review," *Clin Chem Lab Med.*, 45(6):789-796, 2007.
8. Billesbach, T.J., "Applying Lean Production Principles to a Process Facility," *Production and Inventory Management Journal*, 35(3):40-44, 1994.
9. Anon, "Establishing a Lean R&D Organization," *Issue Brief: Research and Technology Executive Council*, Corp Exec Board, September 2006.
10. Kamarck, M., "In the Quest to Manage Capacity, Biology Trumps Stainless Steel," *BioPharm International*, 20:78, 2007.
11. Kamarck, M.E., Hann, L.E., Adamson, S.R., "Biotech Manufacturing Grows Up," *BioPharm International*, 20(10): 159-164, 2007.
12. Bianco, B., Kowalski, G., "Extending "Lean" to Supply Chains," *Automotive Industries*, 185(6): 72-74, 2005.
13. Han, S.H., Chae, M.J., Im, K.S., Ryu, H.D., "Six Sigma-Based Approach to Improve Performance in Construction Operations," *Journal Management Engineering*, 24:21-31, 2008.
14. Yenker, B., "Glossary of "Lean" Manufacturing," *Control Engineering*, 54(5):21, 2007.
15. Greene, A., O'Rourke, D., "Lean Manufacturing Practice in a cGMP Environment," *Pharmaceutical Technology Europe*, 18(10):33-39, 2006.

Concludes on page 58.



## Pharmaceutical Online Is The Online Industry Standard



### Visit The NEW Pharmaceutical Online

An improved Pharmaceutical Online is now live, putting the latest technical, operational, and regulatory information about the global pharmaceutical development and production industry at your fingertips. A host of new features makes it easier than ever before to find exactly what you need, whether it's product overviews, industry news, technical articles, or anything else related to the field. Visit us at [www.pharmaceuticalonline.com](http://www.pharmaceuticalonline.com).

### Join the community and benefit from...

#### Rich Content

- Latest news and groundbreaking research
- Technical articles, case studies, and white papers
- Product, service, and solution information
- Video demonstrations, datasheets, and other free downloads

#### Site Resources

- Locating and sourcing products and services
- Keeping up with industry trends
- Interacting and collaborating with your peers

#### Free Newsletter

- Delivered every Tuesday and Thursday straight to your Inbox

Join the community today at [www.pharmaceuticalonline.com/signup](http://www.pharmaceuticalonline.com/signup)

## About the Authors



**Beth Junker** is a Senior Scientific Director in the Bioprocess R&D Department at Merck & Co., Inc. She is responsible for operational excellence, as well as safety and environmental compliance. She currently is completing her black belt certification. Previously, she was responsible for two non-GMP laboratory and pilot scale bioprocess operation areas, as well as rapid production of reagent proteins. She received her PhD in biochemical engineering from the Massachusetts Institute of Technology and her BSE in chemical engineering from Princeton University. She can be contacted by telephone: +1-732-594-7010 or email: [beth\\_junker@merck.com](mailto:beth_junker@merck.com).

Merck & Co., Bioprocess Research and Development, Merck Research Laboratories, P.O. Box 2000, RY810-127, Rahway, New Jersey 07090, USA.

**Kay Hunsberger** is an Associate Director in the Bioprocess Clinical Manufacturing and Technology Department at Merck & Co., Inc. She is responsible for the infrastructure to the Biologics Pilot Plant. Previously, she was responsible for the release of both pharmaceutical and biological clinical products to clinical trials. She received her BS in biology/marine science and a BA in biochemistry from East Stroudsburg University. She can be contacted by telephone: +1-215-652-1873 or email: [kay\\_hunsberger@merck.com](mailto:kay_hunsberger@merck.com).

**Vicky Griffin** is a Manager in the Bioprocess Clinical Manufacturing and Technology Department at Merck & Co., Inc. She is responsible for raw material planning and release, and GMP document management. She received her BS in biology/vertebrate physiology from Pennsylvania State University and an MS in quality assurance and regulatory affairs from Temple University. She can be contacted by telephone: +1-215-652-8883 or email: [vicky\\_griffin@merck.com](mailto:vicky_griffin@merck.com).

**Kent Hamaker** is an Associate Director in the Bioprocess Clinical Manufacturing and Technology Department at Merck & Co., Inc. Within the Merck Biologics Pilot Plant, he is responsible for production of biological supplies for use in clinical studies. Previously, he was responsible for operational and engineering support for the manufacture of licensed vaccines and biologics at Merck. He received his PhD and MS in biological engineering from Purdue University, and a BS in biological engineering and BS in biochemistry at Texas A&M University. He can be contacted by telephone: +1-215-652-0197 or email: [kent\\_hamaker@merck.com](mailto:kent_hamaker@merck.com).

**Carl Holz** is a Manager in the Bioprocess Clinical Manufacturing and Technology Department at Merck & Co., Inc. He is responsible for business-side implementation of the Clinical Manufacturing Execution System (CMES), as well as other initiatives related to safety and facility infrastructure within the Biologics Pilot Plant at West Point. Previously, he developed business systems in support of GMP qualifica-

tion efforts. He received his BA in chemistry from Western Maryland College and an MBA from National University. He can be contacted by telephone: +1-215-652-0170 or email: [carl\\_holz@merck.com](mailto:carl_holz@merck.com).

**Amy Caparoni** is a Research Biochemical Engineer in the Bioprocess Clinical Manufacturing and Technology Department at Merck & Co., Inc. She is responsible for vaccine and biologics clinical manufacturing planning and execution. She received her MS in biochemical engineering and BS in chemical engineering from Drexel University. She can be contacted by telephone: +1-215-652-2335 or email: [amy\\_caparoni@merck.com](mailto:amy_caparoni@merck.com).

**Kelly Kistler** is an Application Services Analyst in the MRL Information Technology Preclinical and Licensing Information Services Department at Merck & Co., Inc. As a Business Analyst, he is responsible for IT system requirements and testing. Previously, he was responsible for the implementation of various information systems in bioprocess, including LIMS and quality management systems. He received his MS in information science from Penn State University and his BS in biology from Moravian College. He can be contacted by telephone: +1-215-652-1474 or email: [kelly\\_kistler@merck.com](mailto:kelly_kistler@merck.com).

**Jeffrey Graczyk** is a Research Biologist in the Bioprocess Clinical Manufacturing and Technology Department at Merck & Co., Inc. He is responsible for managing staff in the Culture Media and Sterile Supply Organization in the Biologics Pilot Plant, as well as developing and implementing efficiency projects for the department. Previously, he was a supervisor in the Glasswash and Sterile Supply Department within MMD. He received his BS in biology from Millersville University. He also is currently pursuing an MS in manufacturing systems engineering at Lehigh University. He can be contacted by telephone: +1-215-652-7322 or email: [jeffrey\\_graczyk@merck.com](mailto:jeffrey_graczyk@merck.com).

**Marshall Gayton** is Senior Director of the Bioprocess Clinical Manufacturing and Technology Department at Merck, Inc. He is responsible for operations of a multi-product biologics pilot plant and the preparation of bulk clinical supplies for vaccines and therapeutic proteins. Gayton's experience in API and biopharmaceuticals spans more than 20 years, including manufacturing technical support, purification process development, and technology transfer to manufacturing for natural products and vaccines. He received his BS in chemical engineering from Rutgers University and a MS in chemical engineering from Rice University. He can be contacted by telephone: +1-215-652-1337 or email: [marshall\\_gayton@merck.com](mailto:marshall_gayton@merck.com).

Merck & Co., Bioprocess Research and Development, Merck Research Laboratories, P.O. Box 4, West Point, Pennsylvania 19486, USA. 

365

365

365

365



# INTERPHEX365<sup>SM</sup>

Connecting Life Sciences Professionals Globally



Industry & Regulatory News

Global Supplier Directory

Meetings and Events

Education & Training

Community

Careers and more!

Get INTERPHEX365!

[www.INTERPHEX365.com](http://www.INTERPHEX365.com)

Sponsored By:



ENGINEERING PHARMACEUTICAL INNOVATION

This article presents the implementation of a risk-based approach into a supplier's Software Development Workflow and Product's Release Management according to GAMP® 5.

## Using GAMP 5 for Rapid Deployment

by Markus Roemer and Hermann Schaefer

### Introduction

The current IT solution landscape of a typical organization is comprised of many system components, and may include Enterprise Resource Planning (ERP), Manufacturing Execution Systems (MES), Laboratory Information Systems (LIMS), as well as various automation solutions including: Distributed Control System (DCS), Programmable Logic Controller (PLC), Supervisory Control and Data Acquisition (SCADA), and Human Machine Interface (HMI), etc. Traditionally, the search for the best solution has primarily been driven by the functional match of possible solutions against the organization's requirements. The result in most cases is a diverse, multi-faceted solution landscape, where components are provided by different software vendors based on their individual technologies, also referred to as "best-of-breed." These various systems also may be connected using a variety of interfaces. This situation poses several challenges for the healthcare industry, including significant costs for providing the appropriate IT infrastructure, development of interfaces to synchronize the various solutions, which in most cases becomes a focus of compliance activities, and last but not least, the maintenance and support costs.

IT solutions are utilized for many reasons, and among them the automation of the business process is a significant driver, with the aim of

increased efficiency of operations, driving down the costs, and improving data flow through the enterprise making data available wherever needed.

If automation of the business process is a key driver, why reduce the resulting benefits by applying a diverse IT landscape which increases cost of IT operation and increases risk of compliance based on complex interfaces? The answer may be that traditionally the systems were focused on particular functionality and thus could not always meet a broader set of business requirements, hence the need to purchase disparate systems to meet all requirements. However, that situation is changing and more healthcare companies are defining their IT landscape based on the "best-in-class" model, where solutions are selected that may not always provide the best functionality for a particular process ("best-of-breed"), but that are superior over a broad range of functional aspects, including homogeneous infrastructure aspects and technological innovation.

### Market Trends and Customer Needs

From a user's perspective, the ideal world would be to have one solution to meet all of their requirements and ideally one technology platform to host the entire solution.

Over the years, both ERP and automation

Figure 1. Release management.

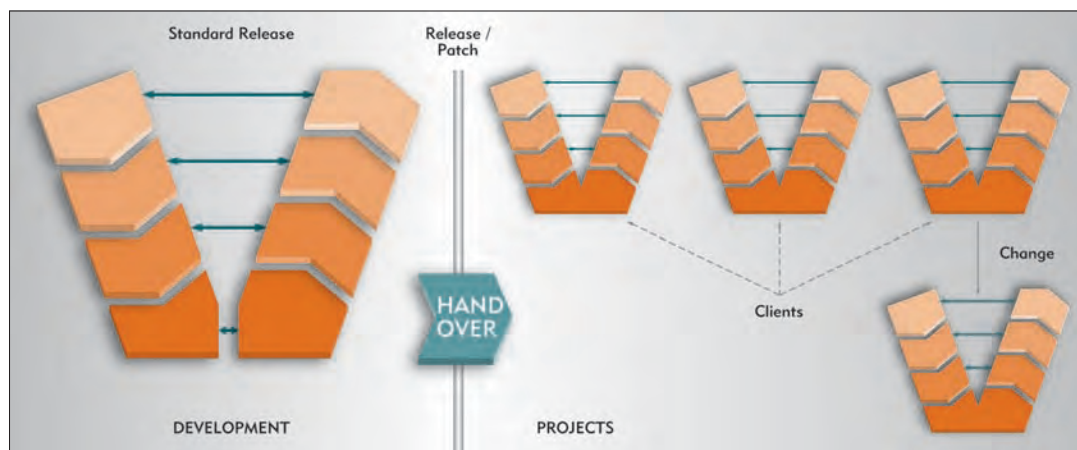

Continued on page 62.



## GEA Niro Soavi Laboratory Homogenizer *type PANDA™* **2K 1001L**

The PANDA™ NS1001 2K is a bench top unit capable of handling a broad range of applications including cell rupture, particle size reduction and emulsions. The PANDA™ 2K with its small hold-up volume and flow rate is ideal for processing small batches of product with results that are directly scalable through to pilot and production machines operating at up to 5500 l/h.

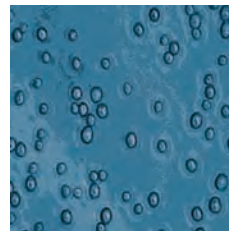

Before

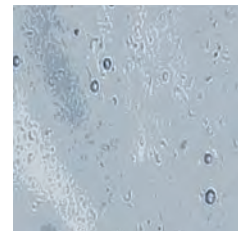

After

PANDA™ NS1001 2K Specifications and Performance:

- Operating pressure 0 – 1500 bar
- Flow rate up to 12 l/h @ 1500 bar
- Minimum sample volume 200ml
- Maximum product viscosity 2000 cPs (20,000 with optional pressure feed)
- Maximum inlet particle size = 0.5mm
- Optional 2nd stage homogenizing valve
- Suitable for CIP and SIP
- ½" Tri Clamp inlet/outlet connections
- Dimensions – L800mm x W460mm x H420mm
- Weight – 85 kg
- 1.8 kW 3ph/60Hz/ 208, 230 or 460V motor (only utility requirement)
- Optional inverter available to allow 1ph/ 60Hz/200-240V power supply

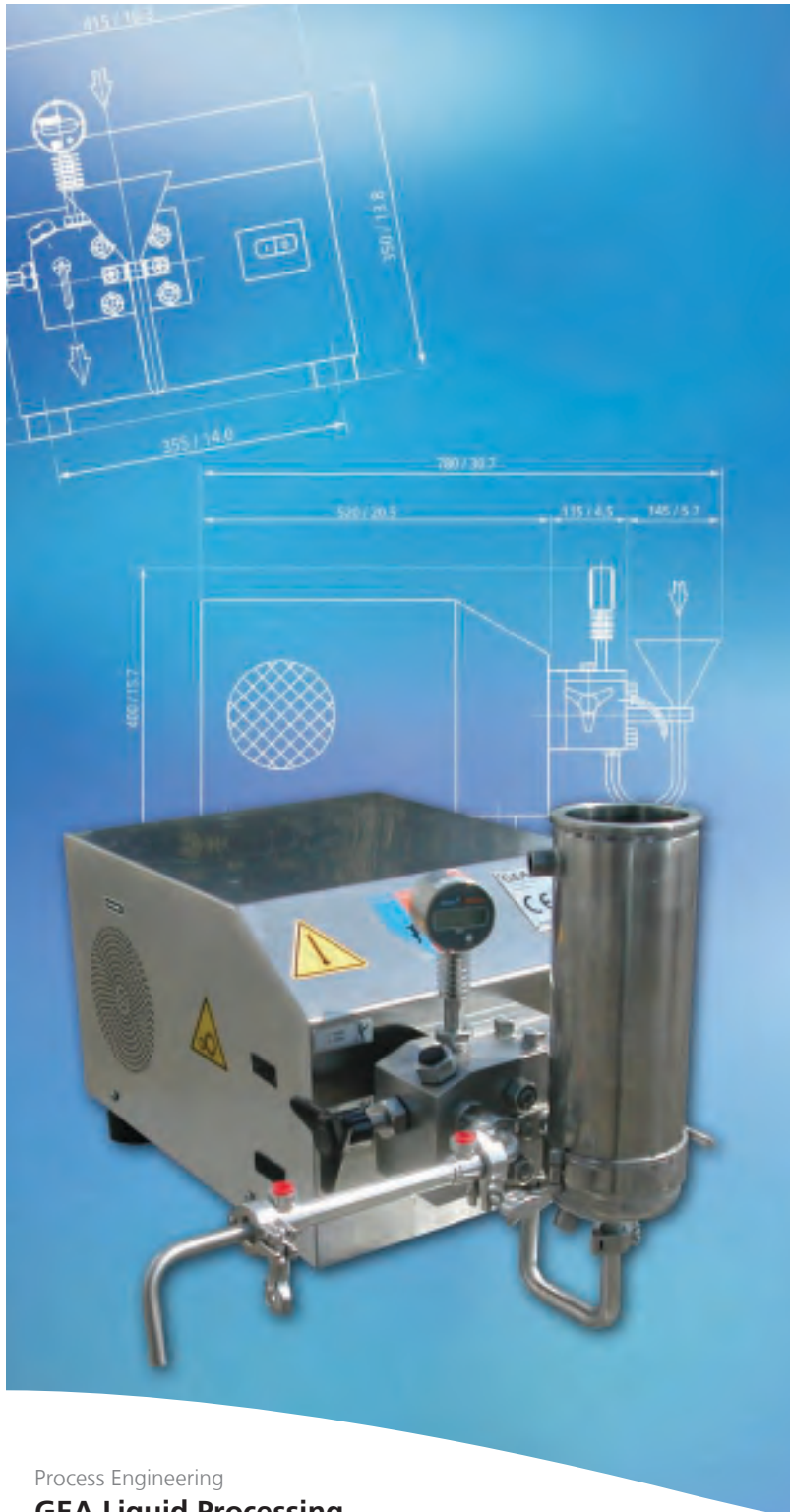

Process Engineering

### GEA Liquid Processing

GEA Process Engineering Inc. • 9165 Rumsey Road • Columbia MD 21045  
Tel: 410 997 8700 • Fax: 410 997 5021  
E-mail: [info@niroinc.com](mailto:info@niroinc.com) • Website: [www.niroinc.com](http://www.niroinc.com)

**Engineering Excellence.**

control vendors have been trying to increase their footprint and provide functionality extending into other areas such as LIMS and Electronic Batch Records. While a clear leader has not yet emerged, there are dominant software product providers who have captured almost all of the enterprise business.

With that in mind, how could further software be developed that could both take advantage of an established IT infrastructure and also could be rapidly deployed?

Let us consider one of the first operational steps in pharmaceutical manufacturing: “Weighing and Dispensing.” There are many systems on the market, but they are typically standalone solutions using their own databases. The automation aspects are not normally challenging since integration is likely limited to scales and possibly bar code equipment. However, integration also is required with the ERP system holding the master product definition, Bill of Materials (BOM), and recipes.

The remainder of this article describes an approach taken to develop weigh and dispense management software based on the key concepts and principles described in GAMP® 5, which can be rapidly deployed by healthcare organizations while taking advantage of existing IT infrastructure. The solution is based on the Systems, Applications, and Products (SAP) Manufacturing Integration and Intelligence (MII) module, which is a tool that can be used to populate all of the SAP transactions, and at the same time, enable business logic and rules to be created. While MII is a tool box and does not provide a packaged solution, it is an appropriate basis for a weighing and dispense solution to meet the following objectives:

- completely based on the ERP
- no other IT infrastructure required for application and database servers
- reuse of the recipe information and order management
- online communication and feedback to the ERP
- one master for batch information and inventory control
- online interface to the scales
- ERP as the one place to hold complete batch information (batch record)

## Pre-Configured, Specified, and Verified

Once the development framework had been selected, a challenge was to work out how the software could be developed such that it could be deployed quickly and cost effectively in a regulated and compliant healthcare environment. The issue was to understand how the requirements of the healthcare customer can be best supported by software development activities to avoid duplication of these activities during deployment. In other words, the idea was not only to focus on the functions, features, and the infrastructure requirements during software development, but also on the typical deployment strategies used in the healthcare industry; the overall objective being to supply software to the healthcare customer with supporting documentation to show that it had been fully specified and verified.

## Release Planning

The release planning phase was the initial phase of the project.

The need for a system was identified with an understanding of the business case and processes to be supported by the system. The scope of the project, the risks involved, business benefits, validation and compliance approaches, and current technologies were examined. Also an extensive analysis of the relevant regulations (EMEA, US FDA), including 21 CFR Part 11 requirements was executed in this early stage to ensure a top-down, risk-based approach for covering these requirements and enabling a ready-to use application and implementation.

The regulatory impact of the system must be understood, and a comprehensive and holistic approach to achieving compliance is an essential part of the planning phase for regulated compliant solutions. Therefore, a solution based on the GAMP® 5 Guide<sup>1</sup> was established, which associated development activities with subsequent customer activities during deployment. This was in order to help customers avoid duplication of unnecessary specification and verification activities during deployment. Also it was very important to define and cover different configuration items for the software solution at this early design phase of the system.

This Standard Release concept is shown in Figure 1; the standard release was fully specified and verified according to GAMP software Category 5 requirements (custom build software). The only difference being that the user acceptance testing phase was executed with a “virtual standard customer.” This Standard Release contained all essential deliverables and executions, starting with the requirement specifications, functional specifications, technical specifications, software development, and several test phases from developer’s test, system test, and acceptance test.

While the requirements were derived from various user requirements and also technical aspects and industry standards, at this stage of the development life cycle, they were called System Requirements. This is a significant advantage at the time the standard software is subsequently applied as part of a customer project – at that point, the user requirements can be mapped to the systems requirements, and gaps can be easily identified without the necessity to always analyze the functional and technical details.

The Standard Release also included a risk management plan, user and administration manuals, and other supporting documentation, like standard templates and white papers. This approach forms the basis for saving time and effort during deployment and implementation for each customer rollout.

At the end of this process, the Standard Release was fully specified and verified and could be used, with all associated documentation deliverables, as the technical basis for any customer project. The project implementation is described in detail later in this article.

Each customer project can be handled as GAMP software Category 4 (configured product) and additionally, from a supplier’s perspective, multi-client projects can be handled and organized from a release, maintenance, service, and project management point of view.

## Quality Planning and Compliance Concept

Based on a certified Quality Management System, this Stan-

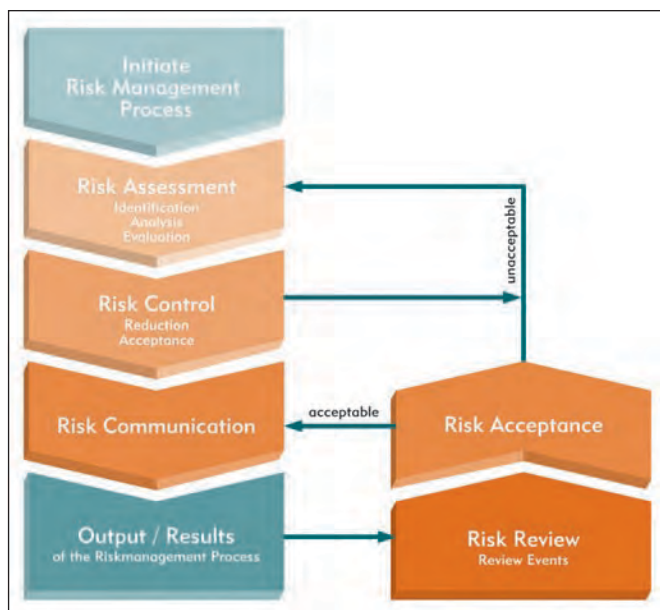

Figure 2. Quality risk management (software development).

standard Release concept was established within a framework of procedures and work instructions for project and release management, specification, verification, and software development. The basic concept was planned and documented with a detailed Release Quality Project Plan, where roles and responsibilities, project and documentation tasks for each release step were defined. Each stage required the involvement of Subject Matter Experts (SME), for different interdisciplinary areas like applicable regulations, basic and technical design, compliance, support (hand over processes), and documentation.

A risk management plan included an analysis of the applicable predicate rules for the weighing process and execution based on other guidelines like *ICH Q9*<sup>9</sup> for a risk-based approach - *Figure 2*. The risk analysis was executed with the *Failure Mode and Effects Analysis* (FMEA) methodology based on a detailed process description and mapping (within the project team, this analytical approach of severity, occurrence, and detection was very quickly seen as an excellent tool for system design and requirements setup). Also the level (number) of severity could be ranked as the GxP impact, and the level of occurrence and detection could be reduced by system control or preventative actions. This approach enabled an early “quality by design” process related to the IT system.

Each process step was examined for possible failures in a process design – quality and reliability – the release and quality team received much information about how to alter the system functions, software development, or manufacturing process in order to avoid these failures. Actions for risk reduction (or risk mitigation) were setup in the scope of system functions, which had to be defined in the system requirements and functionally described in the corresponding functional specifications. These so called system requirements were the “user requirements” for the standard release. This working process was continued within the iterative risk process until a pre-defined acceptable risk ranking was achieved. This ap-

proach also was essential for the verification and test planning, because relevant system functions were identified and classified on their relevance to their risk reduction factor.

The requirements analysis phase, in parallel with the risk management activities, encompassed both the regulatory and functional requirements of the system from the customers’ perspective and the technical requirements from the developers and implementers’ perspective. Functional requirements identify the expected capabilities of the system for risk reduction, capturing what the system will do without defining how it will do it. Therefore, the Functional Specification was written on the basis of so called Use Cases, where the real process was transformed into a system process in terms of sequential setup of workflows (user wizards). These technical requirements like wizard work flows, system plausibility checks, and control functions identify the technical conditions necessary for compliant operation of the system for the future use within the regulated environment.

The intent of the design phase was to capture how the requirements would be met - *Figure 3*. The functional and technical requirements identified during the requirements analysis phase were translated so that the proposed system could be described in terms of software objects down on each field level, such as database tables, data requirements, and program components (i.e., windows, buttons, fields, functions, prompts, constraints, interfaces, etc.). In addition, this level of detail ensured a better transfer of information to the software developers and enabled a higher level of possible software testing in the subsequent verification processes.

For this process of requirements and testing management, the Extensible Mark-up Language (XML) was chosen, individually customized, and used. In general, XML is a general-purpose specification for creating custom mark-up languages that allows its users to define their own elements. Its primary purpose is to help information systems share structured data and it is used both to encode documents and to serialize data.

The test script generation for the related test phases was automated so that any change cycles could be executed more quickly and effectively. A correlation was maintained between the elements of the various phase deliverables and supporting documents; for example, the correlation between the system requirements and functional design/specification and the test cases that challenge them. This structured data handling facilitates maintenance of the cross-referencing between predicate rules, requirements, the corresponding software elements and the test cases that challenge them, as well as the software code.

## Software Development

As a result of the risk-based functional and technical process, the release development team started to create code. The Software Development Lifecycle (SDLC) was composed of phases during which the software system was conceptualized, created, implemented, and maintained. Each technical description was logically broken down to development orders that were assigned to individual developers. A workflow management

*Continued on page 64.*

tool handled these working packages, where pre-defined steps, like development analysis (i.e., analysis of side impacts, etc.), module specification, and unit testing were executed. Also this process ensured that each development and code generation was executed by at least two independent persons, under control of the lead developer. Additionally, the source code entries were referenced and managed by a source code management tool, which also offers many more capabilities for code generation and testing. GAMP@5 references different standards such as Capability Maturity Model® Integration (CMMI®<sup>3</sup>) and ISO 12207<sup>4</sup> (software process models). Both models give a detailed methodology and structure for software development and should be used as guidance documents for assessing, analyzing, and improving the current software development workflow or to set up a new framework.

The development workflow enabled clear project control and status, because the software development was divided into logical working units with separate status of each development package. After all development orders were completed, the development phase was finalized and the first release build was available for system testing. Release management and a final development report for each release or build were essential for the test execution on a test environment.

During the system testing phase, verification against the written technical specification was performed to ensure that the use case flow, user and system interfaces, and different configuration item settings were technically correct and in alignment with the technical and functional requirements. Testing was documented via organized test plans and scripts – referenced to the specifications by unique ID numbers and a final test report of the results was produced.

A quality report and a certificate were issued for this fully specified and verified Standard Release, which stated all the activities, results, created deliverables and actions during software development.

As described earlier in this article, this Standard Release can now be used for customer projects and implementations. An additional product white paper and a supplier audit offer the possibility to assess this approach for subsequent usage by the customer during system deployment and implementation.

## Project Implementation

The project implementation phase comprises the activities required to coordinate the controlled and successful rollout of the system into the client's environment and to determine that the system fulfils the specific requirements.

Based on the fully specified and verified Standard Release concept, a basic workflow for the project implementation can be defined. The first and most important step is to compare the customer requirements, normally written down in a User Requirement Specification by the customer or optionally within shared workshops along a prototyping concept with the corresponding system requirements and functions of the standard release. This Gap Analysis between customer's user and system requirements and the standard release specification determines whether:

- standard release function covers the requirements
- customer-specific requirements need to be realized by configuration
- customer-specific requirements need to be realized by development or code change

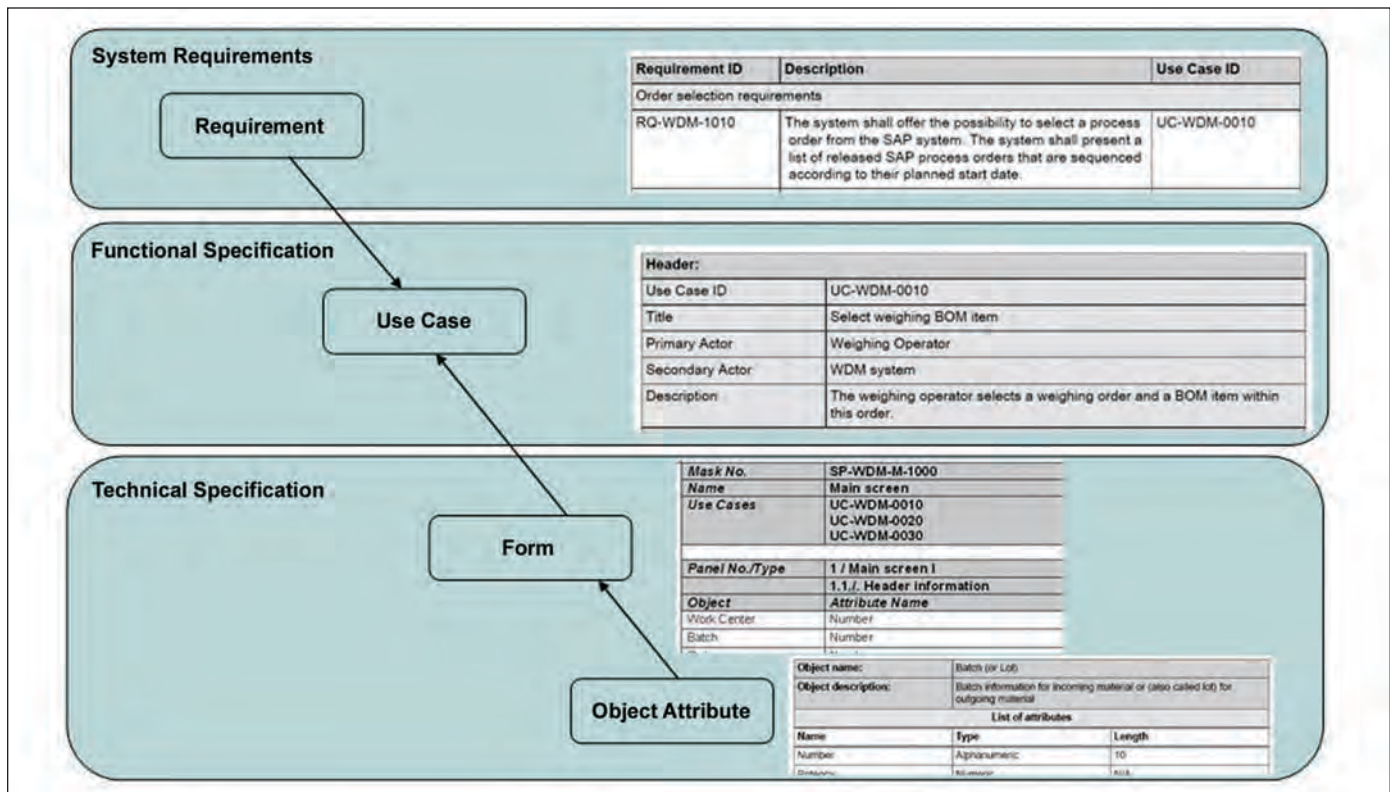

Figure 3. System specifications and design documents.



The result of the Gap Analysis is an important input into the implementation and project setup.

Typically, about 80 to 90% of the requirements can be covered by the standard release or by configuration of specific configuration items. This implies that the implementation can be managed following the approach for GAMP software Category 4. The remainder of the functionality must follow the approach for GAMP software Category 5, where the main efforts of the customer can be concentrated during specification and verification.

Most specification and verification has already been completed during the software development and release stage and the development workflow and tools are already established during the standard release period. The customer implementation phase should follow pre-defined processes, and be based on identified risks. The customer's Validation Plan should reference the Standard Release Quality Project Plan, and describe how supplier documents are to be leveraged.

This approach is beneficial in terms of software quality, meeting regulatory requirements, quality risk management, process control, and project time and costs. It also assists the supplier with system and operations support and multi-customer relations (e.g., bug-fixing, release, and upgrade management).

## Conclusion

In today's world, features and functions of software are not the only important aspects when selecting the most suitable and most efficient software solution. The best balance needs to be found between the following aspects:

- requirements and functional match
- compatibility with a common IT solution framework and infrastructure
- implementation time
- achieving and maintaining compliance with regulatory requirements
- interoperability between systems.

However, it is the end users challenge to select the right solution, which these days is not only defined by the operating system or database – it also is influenced by the most common and dominant software solutions within the overall IT landscape. It is the responsibility of software vendors to adopt the most appropriate development strategies, which allows for fast deployment, seamless integration, “ready-to-run” configurations, and provision of appropriate specification and verification documentation. Benefits of the approach described in this article include:

- single set of master data
- no interfaces and synchronization
- one IT systems landscape
- rapid deployment based on pre-configured, specified, and verified solutions
- industry specific implementation methods

## References

1. *GAMP® 5: A Risk-Based Approach to Compliant GxP*

*Computerized Systems*, International Society for Pharmaceutical Engineering (ISPE), Fifth Edition, February 2008, [www.ispe.org](http://www.ispe.org).

2. ICH Q9-Quality Risk Management – International Conference on Harmonisation of Technical Requirements for Registration of Pharmaceuticals for Human Use, 2005.
3. CMMI® for Development (CMMI-DEV), Capability Maturity Model® Integration, Technical Report CMU/SEI-2006-TR-008, Software Engineering Institute, 2006.
4. ISO 12207; (ISO/IEC 12207:2008), Software Life Cycle Processes, International Organization for Standardization, 2008.
5. Product white paper: SYPROS WDM – Systec Production Suite Weigh and Dispense Management based on SAP MII® and SAP NetWeaver® platform.

## About the Authors



After studying physics, **Markus Roemer** started his career at Vetter Pharma Fertigung as a computer system validation specialist and joined Rockwell Automation Propack Data in 2001. Since 2003, he has been working in various global validation and consultancy functions in the pharmaceutical industry. He has a wide range of validation knowledge and experience

in aligning IT compliance, quality risk management, software development, and quality management systems. Before joining Systec & Services, Roemer was Senior Validation Consultant at Invensys Validation Technologies, Montreal and headed different local and global positions. In his current position as Director Compliance Management at Systec & Services, he oversees consultancy services for IT Management and Compliance, Validation, and Quality Management. Roemer is ISPE Ambassador of the DACH Affiliate. He can be contacted by telephone: +49-751-3545-0890 or by email: [roe@systec-services.com](mailto:roe@systec-services.com).



**Hermann Schaefer** has worked in the software solution business focused on the life sciences industry for the past 15 years. He was responsible for a number of global projects and rollouts as part of multi-international organizations. He knows the requirements and specifics of production management systems for the commercial manufacturing, R&D, and Clinical Studies and

Supplies. Previously, he worked in various roles in Professional Services, Business Management, and Sales, both on a national and international basis. Before starting at Systec & Services, Schaefer was a Vice President and part of the Executive Management Board at POET AG and before that he led the European Sales team in the Life Sciences Vertical at Rockwell Automation's Information Solutions group. Currently, he is a Managing Director at Systec & Services GmbH, responsible for sales, marketing, consulting, and research and development. He holds a BS in electrical engineering. He can be contacted by telephone: +49-721-6634-360 or by email: [hes@systec-services.com](mailto:hes@systec-services.com).

Systec & Services, Emmy-Noether-Str. 9, Karlsruhe, 76131 Germany. 

# ISPE Japan Affiliate Tours US Pharmaceutical Companies

by Osamu Matsumoto and Michael Lucey, ISPE Japan Affiliate

Since its establishment in 2002, the ISPE Japan Affiliate has each year offered its members the opportunity to join a tour of pharmaceutical facilities in the US, combined with follow-up participation at the ISPE Annual Meeting. Planning for the 2008 Plant Tour was provided by Affiliate Directors/Members Shigeru Nakamura, Osamu Matsumoto, Masayuki Akutagawa, and Michael Lucey.

In addition to overseas plant visits, the Tour brings the benefit of broad exposure to ISPE. The 2008 version included a Facility of the Year Award (FOYA) Category Winner, while attendance at the Annual Meeting brought participants into contact with diverse areas of the Society's activities. The expectation is for future broad interaction between Japanese and international COPs, as well as a further level of participation in future ISPE-organized meetings through attendance at educational sessions and presentations.

A total of 13 applicants from Japan signed up for the 2008 Plant Tour/Annual Meeting in Boca Raton, Florida. The mission was made up of three representatives from pharmaceutical manufacturers in Japan, four from engineering companies, three from construction companies, and three from equipment suppliers. The overall itinerary was as follows:

## October

- 21 Depart for United States
- 22 Lonza Biologics (Hopkinton, Massachusetts) and Abbott Laboratories (Worcester, Massachusetts)
- 23 Bristol-Myers Squibb (New Brunswick, New Jersey)
- 24 Schering-Plough (Kenilworth, New Jersey) and Cephalon (Frazer, Pennsylvania)
- 25-29 Attend Annual Meeting (Boca Raton, Florida)
- 30 Paul Mueller Company (Springfield, Missouri, as optional tour)

## November

- 1 Return to Japan

For the Japanese, the period in the US prior to Boca Raton proved to be an invaluable preparation for the Annual Meeting itself; for some, this was even a time to work at overcoming language and cultural challenges. Moreover, the several days together permitted valuable bonding, as well as information exchanges, between Tour members.

The Tour was coordinated around visits to diverse pharmaceutical facilities: an existing biopharmaceutical development facility and a soon-to-be-completed leading-edge bio plant; new as well as renovated facilities for bio-based investigational drugs through to early phase of production; a mega-sized manufacturing plant and its automated warehouse; and a pilot plant for (small molecule) chemical-based drugs synthesis.



Neil Martin of BMS welcomes the plant visitors.

Additionally, Tour participants saw for themselves actual operation of the full-containment facilities, which had contributed to Bristol-Myers Squibb being selected as a Category Winner of 2008 FOYA.

After each plant visit, an internal meeting of Tour members was held in the evening of the same day; general information from observations made and explanations given by plant owners were compiled into a summary report completed while in the US. It was understood throughout that no inside photography of plants visited was permitted and proprietary information had to be respected.

A range of benefits were gained from the Tour. These included a further enhanced recognition of the progress made by pharmaceutical manufacturers and equipment makers in containment, the track record pointing to a mature industry; a better understanding of the development status of biophar-



Japan Affiliate gives an overview presentation at welcome party hosted by the ISPE Delaware Valley Chapter.

*Concludes on page 70.*

# 2009 Facility of the Year Awards (FOYA) Category Winners Announced

Six pharmaceutical manufacturing facilities constructed by companies located in Belgium, India, Ireland, Germany, and Switzerland have been selected as Category Winners in the fifth annual Facility of the Year Awards program sponsored by ISPE, INTERPHEX, and *Pharmaceutical Processing* magazine. The winning companies and respective award categories are:



- **Aseptic Technologies**, located in Gembloux, Belgium, winner of the Facility of the Year Award for Equipment Innovation
- **Centocor Biologics Ireland**, located in Ringaskiddy, Cork, Ireland, winner of the Facility of the Year Award for Sustainability
- **Centocor R&D Schaffhausen**, located in Schaffhausen, Switzerland, winner of the Facility of the Year Award for Facility Integration
- **Hameln Pharma**, located in Hameln, Germany, winner of the Facility of the Year Award for Operational Excellence
- **Orchid Chemicals & Pharmaceuticals**, located in Aurangabad, India, winner of the Facility of the Year Award for Regional Excellence
- **Roche Pharma Biotech Production Basel**, located in Basel, Switzerland, winner of the Facility of the Year Award for Project Execution

In addition, **GlaxoSmithKline Manufacturing** was awarded an Honorable Mention for the company's project in Verona, Italy.

The Facility of the Year Awards (FOYA) program recognizes state-of-the-art pharmaceutical manufacturing projects that utilize new and innovative technologies to enhance the delivery of a quality project, as well as reduce the cost of producing high-quality medicines. Now in its fifth year, the awards program effectively spotlights the accomplishments, shared commitment, and dedication of individuals in companies worldwide to innovate and advance pharmaceutical manufacturing technology for the benefit of all global consumers.

ISPE and *Pharmaceutical Engineering* magazine have released a full-color Facility of the Year Special Edition featuring customized content and case studies of each award-winning project. The FOYA Special Edition will be available online, and the printed version is included with this edition of *Pharmaceutical Engineering*.

The FOYA Special Edition also will have additional distribution at major global industry events, such as INTERPHEX and all 2009 ISPE Conferences, including the 2009 ISPE Annual Meeting where the overall FOYA winner will be announced.

Companies from around the world have already submitted their state-of-the-art facilities to participate in the Facility of the Year Awards program. ISPE, INTERPHEX, and *Pharmaceutical Processing* magazine are looking for projects that demonstrate global leadership by showcasing cutting-edge engineering, innovative new technology, or advanced applications of existing technology. Go to [www.facilityoftheyear.org](http://www.facilityoftheyear.org) to read more about the program and download submission forms. 



Inc. 1955

**ACTIVE CHEMICAL CORP.**

**SPECIALISTS IN . . .**

— LABORATORY CONTROLLED —

- CHEMICAL CLEANING SERVICES OF HEAT EXCHANGE EQUIPMENT
- PASSIVATION OF STAINLESS STEEL PIPING
- STERILIZATION OF PIPING & EQUIPMENT
- SOFTENERS & DEIONIZERS
- RECONDITIONING OF FILTERS & ION EXCHANGERS
- WATER TREATING CONSULTANTS
- BOILER & COOLING WATER CHEMICALS

**SERVICE CONTRACTS**

**(215) 676-1111**

4520 Old Lincoln Hwy.,  
Oakford, PA 19053

## Craftsmanship

**LEE Industries** designs and manufactures the highest quality stainless steel processing vessels and systems for the Pharmaceutical/Bio-Tech, Cosmetic, Food/Beverage and Chemical Industries.

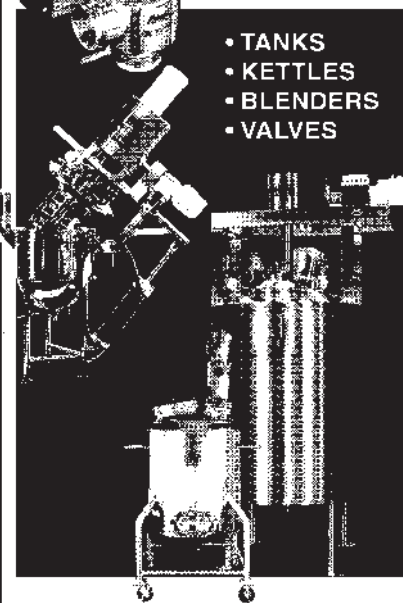

**lee** PROCESS SYSTEMS & EQUIPMENT  
DIVISION OF LEE INDUSTRIES, INC.  
P.O. Box 687 Phillipsburg, PA 16866  
(814) 342-0470 FAX (814) 342-5660  
[www.LEEind.com](http://www.LEEind.com)

Service

## Architects, Engineers – Constructors

CRB Consulting Engineers, 7410 N.W. Tiffany Springs Pkwy., Suite 100, Kansas City, MO 64153. (816) 880-9800. See our ad in this issue.

EI Associates, 8 Ridgedale Ave., Cedar Knolls, NJ 07927. (973) 775-7777. See our ad in this issue.

Parsons, 150 Federal St., Boston, MA 02110. (617)-946-9400. See our ad in this issue.

## Cleanroom Products/Services

AES Clean Technology, 422 Stump Rd., Montgomeryville, PA 18936. (215) 393-6810. See our ad in this issue.

Plascore, 615 N. Fairview, Zeeland, MI 49464. (800) 630-9257. See our ad in this issue.

## Consultants

**CONSTRUCTION RISK CONSULTANTS**  
Claims • CPM Scheduling • ADR  
617-543-6088 www.conrisk.com

## Employment Search Firms

Jim Crumpley & Associates, 1200 E. Woodhurst Dr., Bldg. B-400, Springfield, MO 65804. (417) 882-7555. See our ad in this issue.

## Homogenizers

GEA Niro Pharma Systems, 9165 Rumsey Rd., Columbia, MD 21045. See our ad in this issue.

## Instrumentation

Hach Ultra Analytics, 5600 Lindbergh Dr., Loveland, CO 80539. (970) 663-1377. See our ad in this issue.

## Passivation and Contract Cleaning Services

Active Chemical Corp., 4520 Old Lincoln Hwy., Oakford, PA 19053. (215) 676-1111. See our ad in this issue.

Cal-Chem Corp., 2102 Merced Ave., South El Monte, CA 91733. (800) 444-6786. See our ad in this issue.

## Rupture Discs

Fike Corp., 704 SW 10th St., Blue Springs, MO 64015. (816) 655-4546. See our ad in this issue.

## Sterile Products Manufacturing

**Process Tek - Sterility by Design**  
INNOVATION, RELIABILITY & PROFESSIONALISM  
R&D, Validation, GMP Auditing,  
HACCP, Problem Solving and Training  
for sterile products, packages & processes  
Kailash S. Purohit, PhD  
www.processtek.net • kaipurohit@processtek.net

## Tanks/Vessels

Lee Industries, PO Box 688, Philipsburg, PA 16866. (814) 342-0470. See our ad in this issue.

## Temperature Control Systems

Budzar Industries, 38241 Willoughby Pkwy., Willoughby, OH 44094. (440) 918-0505. See our ad in this issue.

## Used Equipment

### PRE-OWNED FREEZE DRYERS

**Hull Model 8FS12** – Chamber ASME Code design for 0 psig, stainless steel construction including shelves, chamber, chamber door, (5) product shelves, (4) useable 12" wide x 24" deep, 4.5" clearance between shelves, stoppering from bottom up, hydraulic pumping system, internal ice condensing plates providing 12 liters capacity, vacuum pump, refrigeration heat transfer system with 2 KW heater, circulation pump, interconnecting piping, expansion tank, heat exchangers, Voltage 220 volts, 60 cycles, 3 phase.

**Hull Model 36FS75** – Chamber ASME Code design for 0 psig, all stainless steel construction including shelves, chamber, chamber door, (7) product shelves, (6) useable 24" wide x 36" deep, 4.5" clearance between shelves, stoppering from top down, hydraulic pumping system, internal ice condensing plates providing 50 liters capacity, vacuum pump, refrigeration heat transfer system with heater, circulation pump, interconnecting piping, expansion tank, heat exchangers, Voltage 220 or 460 volts, 60 cycles, 3 phase.

**Hull Model 48FS75** – Chamber ASME Code design for 0 psig, all carbon steel construction including shelves, chamber, chamber door, coated with Kynar (9) product shelves, (8) useable 24" wide x 36" deep, 4.5" clearance between shelves, stoppering from top down, hydraulic pumping system, internal ice condensing plates providing 75 liters capacity, vacuum pump, refrigeration heat transfer system with heat transfer heater, circulation pump, interconnecting piping, expansion tank, heat exchangers, Voltage 220 or 460 volts, 60 cycles, 3 phase.

**Hull Model 120FXS200** – Chamber ASME Code design, all carbon steel Heresite coated construction including shelves, chamber, chamber door, (11) product shelves, (10) useable 36" wide x 48" deep, 4.5" clearance between shelves, stoppering from top down, hydraulic pumping system, external ice condensing plates providing 200 liters capacity, vacuum pump, refrigeration heat transfer system with 20 KW heater, sealless circulation pump, interconnecting piping, expansion tank, heat exchangers, Voltage 460 volts, 60 cycles, 3 phase.

## Lyo Renew Associates, Inc.

548 Pinney Road, Huntingdon Valley, PA 19006  
Phone: 215-817-6942, Fax: 215-947-5768  
info@lyorenew.com, www.lyorenew.com

## Valves

Gemu GmbH & Co., Fritz-Mueller-Str. 6-8, D-74653 Ingelfingen, Germany. +49 7940123-0. See our ad in this issue.

Gemu Valves, 3800 Camp Creek Pkwy., Bldg. 2600, Suite 120, Atlanta, GA 30331. (678) 553-3440. See our ad in this issue.

## Water Treatment

Eletracqua Srl, Via Adamoli 513, 16141 Genova, Italy. +39 0108300014. See our ad in this issue.

## JIM CRUMPLEY & ASSOCIATES

### Pharmaceutical Recruiting Specialist

Put our expertise to work for you in:

- Facilities
- Project
- Process
- Validation
- Automation
- Quality Engineering

1200 E. Woodhurst Drive, B-400 • Springfield, MO 65804

Phone: 417-882-7555 Fax: 417-882-8555

E-mail: [recruiter@crumpleyjobs.com](mailto:recruiter@crumpleyjobs.com)

Web site: [www.crumpleyjobs.com](http://www.crumpleyjobs.com)

*We've been getting results since 1977!*

ACTIVE CHEMICAL .....	67
AES CLEAN TECHNOLOGY .....	25
BUDZAR INDUSTRIES .....	17
CAL-CHEM CORP .....	29
COMMISSIONING AGENTS .....	23
CRB CONSULTING ENGINEERS .....	3
JIM CRUMPLEY & ASSOCIATES .....	68
EI ASSOCIATES .....	43
ELETTRACQUA .....	13
EMERSON PROCESS MANAGEMENT .....	9
ENDRESS + HAUSER .....	71
FARR AIR POLLUTION CONTROL .....	2
FDA/US DEPARTMENT OF HEALTH & HUMAN SERVICES .....	69
FIKE CORP. ....	11
GEA PROCESS ENGINEERING .....	61
GEMU GMBH .....	45
GEMU VALVES .....	53
HACH COMPANY .....	15
HOWORTH AIR TECHNOLOGY .....	41
HURST CORP. ....	43
IMA ACTIVE .....	27
INTELLIGEN .....	39
INTERPHEX365 .....	59
LEE INDUSTRIES .....	67
LJ STAR .....	31
NNE PHARMAPLAN .....	72
PLASCORE .....	29
PARSONS .....	5
PHARMACEUTICAL ONLINE .....	57
QPHARMA .....	7
SAINT-GOBAIN PERFORMANCE PLASTICS .....	33
SIEMENS .....	19
TELSTAR .....	49
W.L. GORE & ASSOCIATES .....	37

## Thank You to our Sponsors

### ISPE Tampa Conference

Platinum Level Sponsorship



**PARSONS**

Lanyards

NCA TECHNOLOGIES / NEOCERAM

### ISPE Brussels Conference

Host Sponsor

**SIEMENS**

### INTERPHEX Member Lounge Sponsors



**middough**

**pharmadule**



## U.S. Department of Health and Human Services Food and Drug Administration

### Career Opportunities

HHS/FDA/CDER/Division of Manufacturing and Product Quality, Office of Compliance, located at our new White Oak campus in Silver Spring, Maryland is recruiting CONSUMER SAFETY OFFICERS, INTERDISCIPLINARY SCIENTISTS (biologists, microbiologists, and chemists), PHARMACISTS and STAFF FELLOWS with backgrounds in quality systems and pharmaceutical manufacturing. Applicants with background in quality assurance, solid oral dosage forms, sterile drugs, and equipment, facilities, utilities, instrumentation, and laboratory analysis are encouraged to apply.

We offer:

- Civil Service Salary at the GS-12/13 level, 73,100.00 - 113,007.00
- Excellent Federal Government Benefits Package (health insurance, life insurance, thrift savings plan, retirement)
- Flexible work schedules
- Opportunities to continue Professional Development
- Annual Leave, Sick Leave, Flexible Spending Accounts and long term care insurance

**GENERAL INFORMATION:** Positions being filled as civil service or U.S. Commissioned Corps require U.S. Citizenship. Permanent U.S. Residents may apply for Staff Fellowship program. Graduates of foreign colleges/universities must provide proof of U.S. education equivalency certification.

**COMPLIANCE OFFICER:** Basic Requirements: Candidates should possess a science degree and specific coursework in an appropriate field of study and professional experience. Candidates with Ph.D. or Master degrees in chemistry, biology, pharmacy, engineering, biochemistry, or a B.S. in one of these areas coupled with substantial industry or inspectional experience, are highly desirable. Basic qualifications required for the above positions, except pharmacy, include: 1) a degree in physical sciences, life sciences, or engineering, which includes 30 semester hours in chemistry, supplemented by coursework in mathematics through differential and integral calculus and at least 6 semester hours of physics, or 2) a combination of education and experience-course work equivalent to a major as described above, plus appropriate experience or additional education. To qualify for higher-graded positions, candidates must have additional amounts of either specialized experience or directly related education. The amount of additional experience or education required depends on the grade of the position. For a pharmacy position, a successful completion of a 5-year course of study leading to a bachelor's or higher degree in pharmacy from an approved pharmacy school, or 1 year of professional pharmacy experience equivalent to at least GS-7, or a 6-year course of study leading to a Doctor of Pharmacy (Pharm.D.); 1 year of professional pharmacy experience equivalent to at least GS-9; or, for research positions, completion of all of the requirements for a master's or equivalent degree in a related scientific field. In addition to a background in those fields, the candidate should have excellent communication skills, both oral and written.

Department of Health and Human Services is an Equal Opportunity Employer and has a Smoke-free workplace. If you are interested in considering employment with CDER's Office of Compliance, DMPQ, please submit your resume with a brief cover letter to Kennerly Chapman at (301) 796 3271 or by e-mail, kennerlyk.chapman@fda.hhs.gov

## Pharmaceutical Engineering Launches Digital Edition

ISPE is pleased to introduce a new ISPE Member benefit: the digital edition of *Pharmaceutical Engineering* magazine. The inaugural digital issue (January/February 2009) was delivered to the global membership in a browser-based electronic format. In addition to the digital edition, Members will continue to receive the print version.



The digital edition is a flexible electronic version of the magazine that delivers the look and feel of the print edition. It contains all of the content found in the print edition and is easily accessible via the Internet. In addition, the digital edition of *Pharmaceutical Engineering* contains hotlinks to URLs and email addresses that are referenced within articles and advertising so members will gain instant access to additional information and necessary resources.

Members will get all of the features of the *Pharmaceutical Engineering* magazine print edition with the interactive capabilities only available online. Added benefits of the digital edition of *Pharmaceutical Engineering* include:

- Immediate access and timely information
- Access from email link and the Web site
- Faster delivery
- Improved international delivery
- Entire magazine exactly as it appears in print
- High-quality graphics
- Table of Contents links to articles
- Easy-to-use hotlinks to advertiser sites/email capability
- Viewable through your standard Web browser
- Issues can be viewed online or downloaded as a PDF to your desktop
- Print one or more pages from the PDF
- Easy-to-read, searchable format within the issue

Each issue of the *Pharmaceutical Engineering* digital edition will be sent to ISPE Members via a dedicated email just prior to the print editions' publication date. ISPE Members will also be able to access the current digital edition by logging on at [www.ISPE.org/pharmaceuticalengineering](http://www.ISPE.org/pharmaceuticalengineering). 

## ...Japan Affiliate Mission

*Continued from page 66.*

maceutical drugs in the industry; and an improved grasp of the extent to which plant owners challenge new technologies in the quest for excellence.

A highlight of the US experience was the Delaware Valley Chapter-hosted "Welcome Party" on 24 October 2008, organized by Chapter Secretary Shannah Schodle, an ideal social environment where lively exchanges of information took place in a dignified, but relaxed setting.

Conversations during the Chapter evening extended from the professional through to the cultural: visitors from Japan learned World Series baseball chants to support the local Phillies, and US hosts were taught the traditional Japanese synchronized hand-clap close-out of an event, the so-called "san-bon-jime!"

Certainly, a very special relationship was created between US hosts and Japanese guests, and between Chapter/Affiliate.



Members of the Japan Affiliate and ISPE Delaware Valley Chapter end a memorable evening.

Logistics for the entire trip from Japan were provided by an experienced travel agent with chartered buses at US airports for transfers to hotel and plant. A merit of this arrangement was, for example, the ability to quickly move the visitors from Newark hotel to Manhattan for an evening of sightseeing and dining, a much appreciated interlude after a demanding international and domestic travel schedule!

After returning to Japan, Tour Leader Osamu Matsumoto – the self-styled "Cheerleader" – delivered a summary presentation of the Tour at the Affiliate's Winter Meeting in Yokohama, on 5 December 2008.

Meanwhile, planning is already under way for the Affiliate's 2009 Tour with the focus this year on pharmaceutical-related companies located on the US West Coast, to be followed by participation in the Annual Meeting in San Diego. Hopes are high for an equal level of success in approaching companies to visit, and securing the interest of Japanese membership in participation.

Finally, the Japan Affiliate and its Tour members greatly appreciated the very kind cooperation shown by the US Plants to the visitors from overseas, permitting an unforgettable opportunity to visit their excellent facilities! 



## Our focus: your compliance.

Our innovative technologies combined with our understanding of industry requirements and our commitment to work with you ensure your compliance. You can rely on us to thoroughly assess the risks you face and help you optimize your processes and quality system performance. Endress+Hauser: your partner in creating value. [www.endress.com/life\\_sciences](http://www.endress.com/life_sciences)

Endress+Hauser  
Instruments International AG  
Kägenstrasse 2  
4153 Reinach/BL1  
Switzerland

Phone +41 61 715 81 00  
Fax +41 61 715 25 00  
info@ii.endress.com  
www.endress.com

**Endress+Hauser**   
People for Process Automation

# more than engineering

We are determined to support and **improve technologies** and **standards** in the pharma and biotech industries.

Winner of the ISPE award 2008

## Company of the Year



Consulting



Engineering



Construction



Validation



Solutions

Visit us at **ACHEMA**,  
Frankfurt, Germany.  
11-15 May 2009,  
Hall 9.1, D37-E40

NNE Pharmaplan is the world's leading engineering and consulting company. We enable pharma and biotech companies to bring products to market with fast, innovative and reliable services. We employ more than 1500 people at over 20 locations worldwide.

nne pharmaplan®

[nnepharmaplan.com](http://nnepharmaplan.com)